

 **TRIO**
LIGHTING FOR YOU



OUTDOOR

2021

AUSSENLEUCHTEN
OUTDOOR LUMINAIRES

MITCHELL

Aluminium Druckguss, Acryl
diecast aluminium, acryl
fonte d'aluminium, acryl
gegoten aluminium, acryl
aluminio fundido, acrílico
pressofusione di alluminio, acrilico
fonta aluminiu, acrilic
valualumiini, akryyli
barwione aluminium, akryl

42 Anthrazit · anthracite

Incl. 1 x SMD-LED, 7,5 W
750 lm, 3.000 K

273360142

IP54

Incl. 1 x SMD-LED, 16,5 W
1.800 lm, 3.000 K

473360442

473369442

IP54

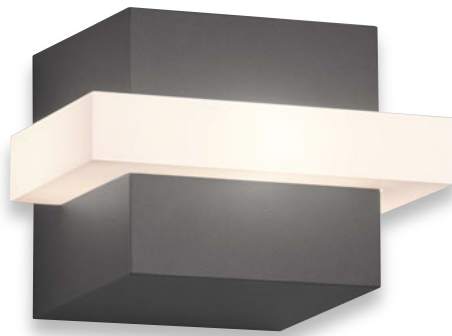

273360142



473360442



473369442

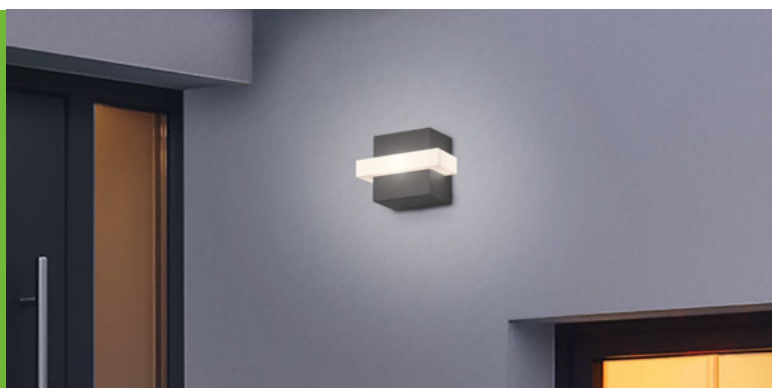
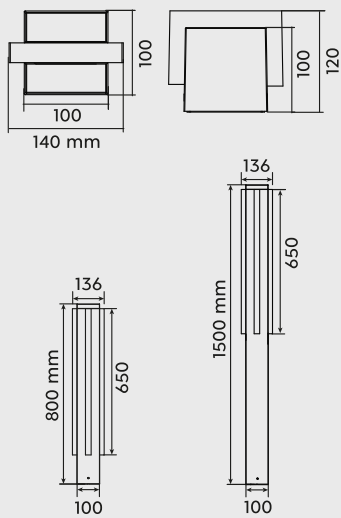



FUERTE

Aluminium Druckguss, Acryl
diecast aluminium, acryl
fonte d'aluminium, acryl
gegoten aluminium, acryl
aluminio fundido, acrílico
pressofusione di alluminio, acrilico
fonta aluminiu, acrilic
valualumiini, akryyli
barwione aluminium, akryl

42 Anthrazit · anthracite

Incl. 1 x SMD-LED, 10,5 W
1.300 lm, 3.000 K

226260142

IP54

Incl. 1 x SMD-LED, 15 W
1.700 lm, 3.000 K

426260142

526260142

IP54



226260142



426260142



526260142

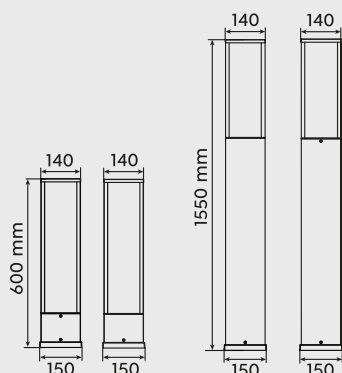
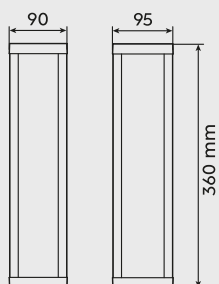



222

LOGONE

Aluminium Druckguss
diecast aluminium
fonte d'aluminium
gegoten aluminium
aluminio fundido
pressofusione di alluminio
fonta aluminiu
valualumiini
barwione aluminium

42 Anthrazit · anthracite

Incl. SMD-LED, 11 W
1.100 lm, 3.000 K

IP65

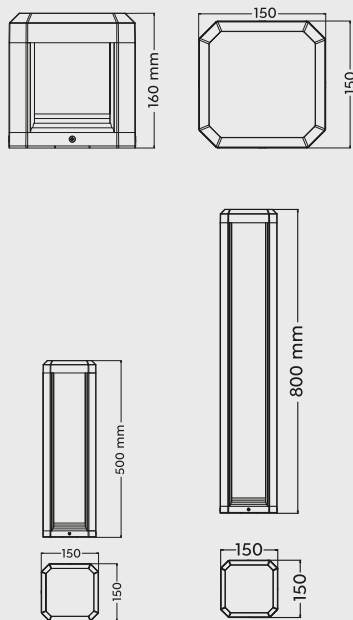

222360142



522360142



422360142





KATUN

Aluminium Druckguss
diecast aluminium
fonte d'aluminium
gegoten aluminium
aluminio fundido
pressofusione di alluminio
fonta aluminii
valualumiini
barwione aluminium

42 Anthrazit · anthracite

Incl. 1 x SMD-LED, 5 W
500 lm, 3.000 K

IP54

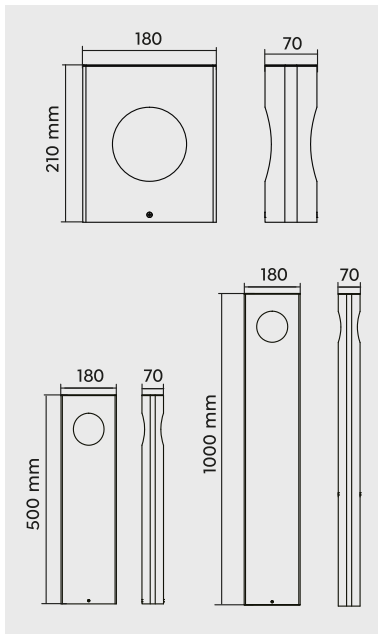

226160142



526160142



426160142





RENO

Aluminium Druckguss
diecast aluminium
fonte d'aluminium
gegoten aluminium
aluminio fundido
pressofusione di alluminio
fonta aluminu
valualumiini
barwione aluminium

42 Anthrazit · anthracite

Incl. 1 x COB-LED, 4,5 W
450 lm, 3.000 K

IP54

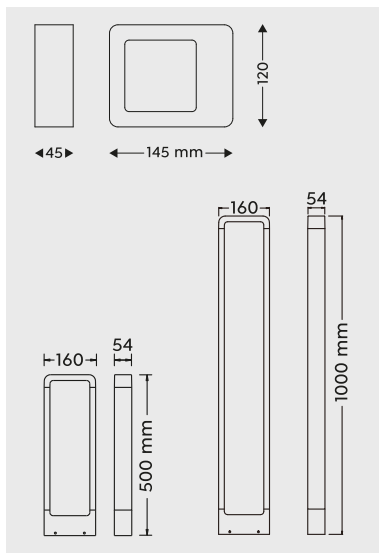

220760142



520760142



420760142

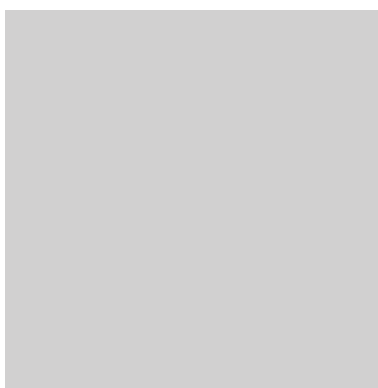
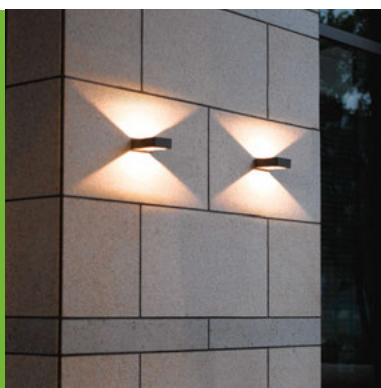



GANGES

Aluminium Druckguss
diecast aluminium
fonte d'aluminium
gegoten aluminium
aluminio fundido
pressofusione di alluminio
fonta aluminu
valualumiini
barwione aluminium

42 Anthrazit · anthracite

Incl. 1 x SMD-LED, 9 W
1.000 lm, 3.000 K

IP54

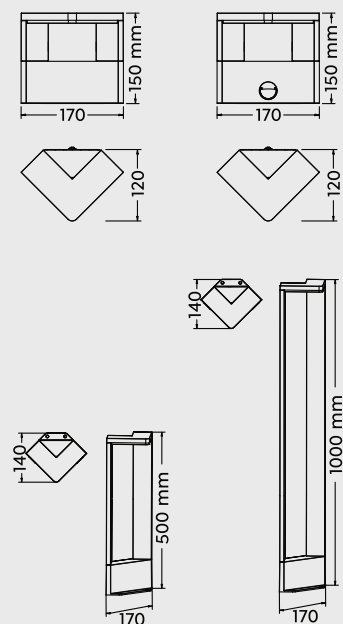

221760142



521760142



421760142





221769142



Bewegungssensor
Motion sensor
Décteur de mouvement
Bewegingssensor
Sensor de movimiento
Sensore di movimento
Senzor de mişcare
Liiketunnistin
Czujnik ruchu

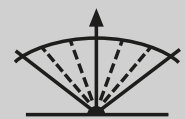

max.
9m/120°

RHINE

Aluminium Druckguss, Kunststoff
 diecast aluminium, plastic
 fonte d'aluminium, plastique
 gegoten aluminium, kunststof
 aluminio fundido, plástico
 pressofusione di alluminio, plastica
 fonta aluminiu, plastic
 valualumiini, muovi
 barwione aluminium, plastik

42 Anthrazit · anthracite

Incl. 2 x SMD-LED, 4,5 W
 2 x 450 lm, 3.000 K

221660242

221669242

Incl. 2 x SMD-LED, 5,5 W
 2 x 600 lm, 3.000 K

421660242

521660242

IP54

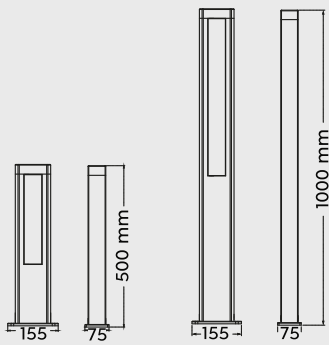
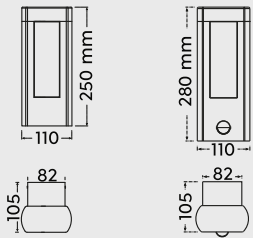

221669242



221660242



521660242



421660242

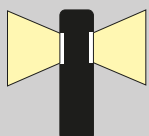

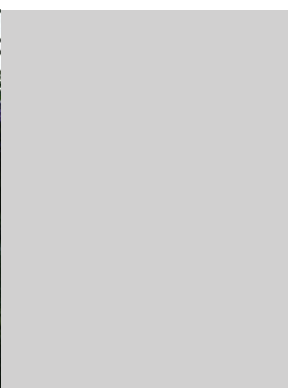

Bewegungssensor
Motion sensor
Décteur de mouvement
Bewegungssensor
Sensor de movimiento
Sensore di movimento
Senzor de mişcare
Liiketunnistin
Czujnik ruchu

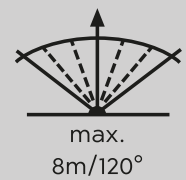

SUEZ

Aluminium Druckguss, Kunststoff
diecast aluminium, plastic
fonte d'aluminium, plastique
gegoten aluminium, kunststof
aluminio fundido, plástico
pressofusione di alluminio, plastica
fonta aluminiu, plastic
valualumiini, muovi
barwione aluminium, plastik

42 Anthrazit · anthracite

Incl. 1 x SMD-LED, 8,5 W
1.000 lm, 3.000 K

IP54

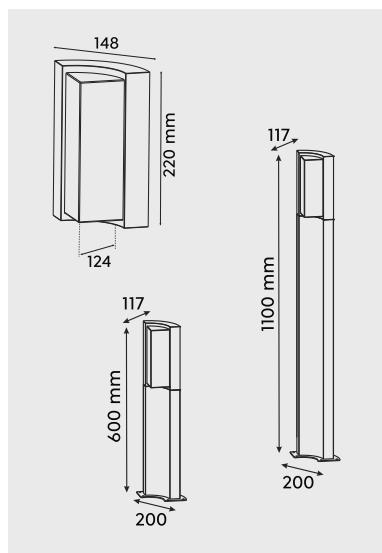

220360142



520360142



420360142

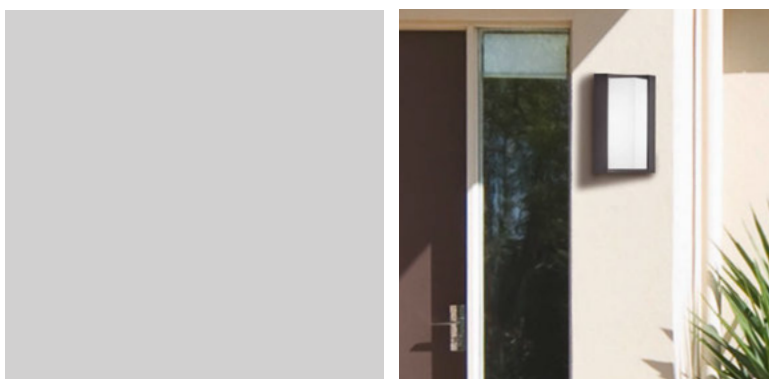



TICINO

Aluminium Druckguss, Kunststoff
diecast aluminium, plastic
fonte d'aluminium, plastique
gegoten aluminium, kunststof
aluminio fundido, plástico
pressofusione di alluminio, plastica
fonta aluminiu, plastic
valualumiini, muovi
barwione aluminium, plastik

42 Anthrazit · anthracite

Incl. 1 x SMD-LED, 5,5 W
550 lm, 3.000 K

IP54



221260142



421260142



521260142

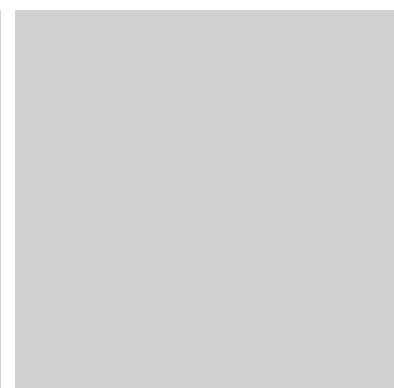
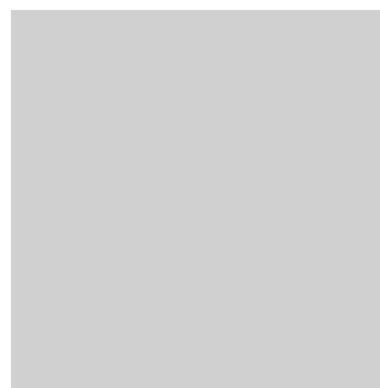
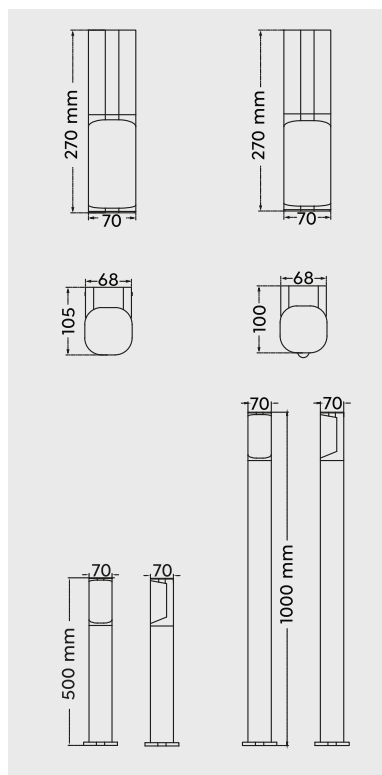



221269142



Bewegungssensor
Motion sensor
Détecteur de mouvement
Bewegingssensor
Sensor de movimiento
Sensore di movimento
Senzor de mișcare
Liiketunnistin
Czujnik ruchu

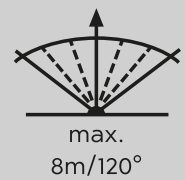

SHANNON

Aluminium Druckguss, Kunststoff
diecast aluminium, plastic
fonte d'aluminium, plastique
gegoten aluminium, kunststof
aluminio fundido, plástico
pressofusione di alluminio, plastica
fonta aluminiu, plastic
valualumiini, muovi
barwione aluminium, plastik

42 Anthrazit · anthracite

Incl. 1 x SMD-LED, 7 W
700 lm, 3.000 K

IP54

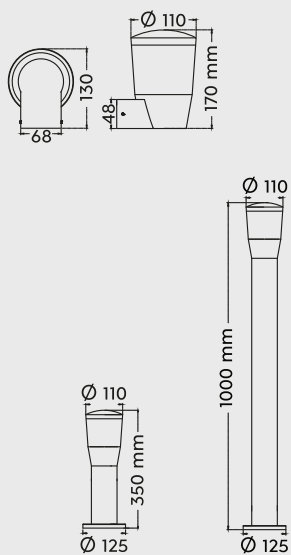

222060142



522060142



422060142

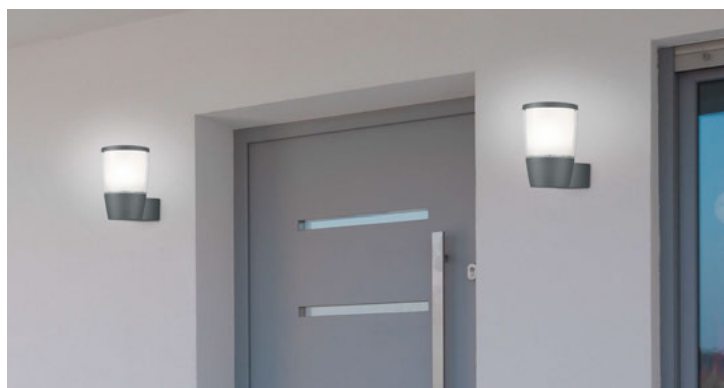



EBRO

Aluminium Druckguss, Kunststoff
diecast aluminium, plastic
fonte d'aluminium, plastique
gegoten aluminium, kunststof
aluminio fundido, plástico
pressofusione di alluminio, plastica
fonta aluminiu, plastic
valualumiini, muovi
barwione aluminium, plastik

42 Anthrazit · anthracite

Incl. 1 x SMD-LED, 6 W
650 lm, 3.000 K

IP54



222160142



522160142



422160142

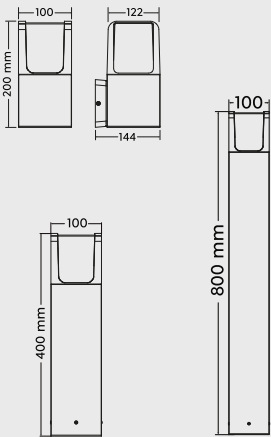

EBRO

Aluminium Druckguss, Kunststoff
diecast aluminium, plastic
fonte d'aluminium, plastique
gegoten aluminium, kunststof
aluminio fundido, plástico
pressofusione di alluminio, plastica
fonta aluminiu, plastic
valualumiini, muovi
barwione aluminium, plastik

42 Anthrazit · anthracite

Incl. 1 x SMD-LED, 6 W
650 lm, 3.000 K

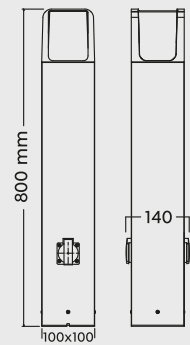

422167142

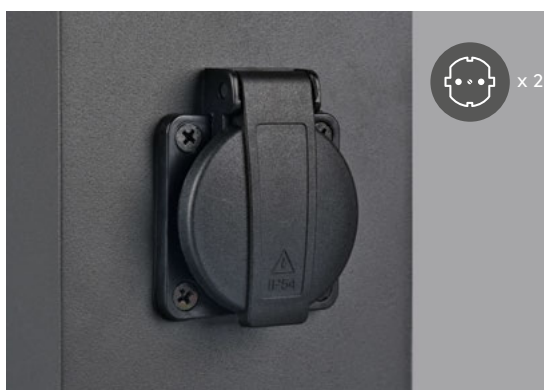

GAMBIA

Aluminium Druckguss, Kunststoff
diecast aluminium, plastic
fonte d'aluminium, plastique
gegoten aluminium, kunststof
aluminio fundido, plástico
pressofusione di alluminio, plastica
fonta aluminiu, plastic
valualumiini, muovi
barwione aluminium, plastik

42 Anthrazit · anthracite

Incl. 1 x SMD-LED, 10,5 W
1.050 lm, 3.000 K



223669142



423669142

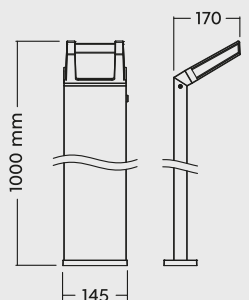
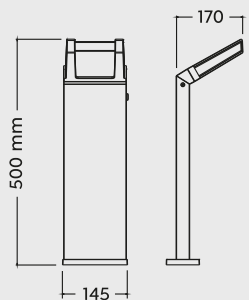
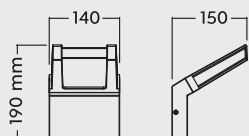

523669142



Dämmerungssensor
Dusk sensor
Décteur de crépuscule
Schemeringsensor
Sensor de oscuridad
Sensore crepuscolare
Senzor de lumina/amurg
Hämärätunnistin
Czujnik zmierzchowy





PEARL

Aluminium Druckguss, Kunststoff
 diecast aluminium, plastic
 fonte d'aluminium, plastique
 gegoten aluminium, kunststof
 aluminio fundido, plástico
 pressofusione di alluminio, plastica
 fonta aluminiu, plastic
 valualumiini, muovi
 barwione aluminium, plastik

42 Anthrazit · anthacite

Incl. 1 x SMD-LED, 9 W
 900 lm, 3.000 K



221169142



521169142



421169142

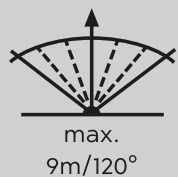
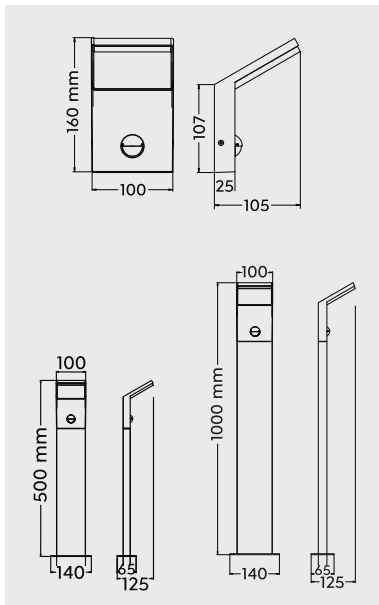

Bewegungssensor
 Motion sensor
 Détecteur de mouvement
 Bewegungssensor
 Sensor de movimiento
 Sensore di movimento
 Senzor de mişcare
 Liiketunnistin
 Czujnik ruchu





PEARL

Aluminium Druckguss, Kunststoff
diecast aluminium, plastic
fonte d'aluminium, plastique
gegoten aluminium, kunststof
aluminio fundido, plástico
pressofusione di alluminio, plastica
fonta aluminiu, plastic
valualumiini, muovi
barwione aluminium, plastik

42 Anthrazit · anthacite

Incl. 1 x SMD-LED, 9 W
900 lm, 3.000 K

IP54

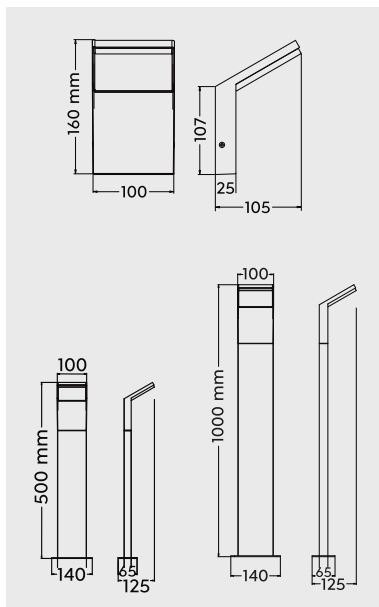

221160142



521160142



421160142





NELSON

Aluminium Druckguss
diecast aluminium
fonte d'aluminium
gegoten aluminium
aluminio fundido
pressofusione di alluminio
fonta aluminiu
valualumiini
barwione aluminium

42 Anthrazit · anthracite

Incl. 1 x SMD-LED, 8 W
850 lm, 3.000 K

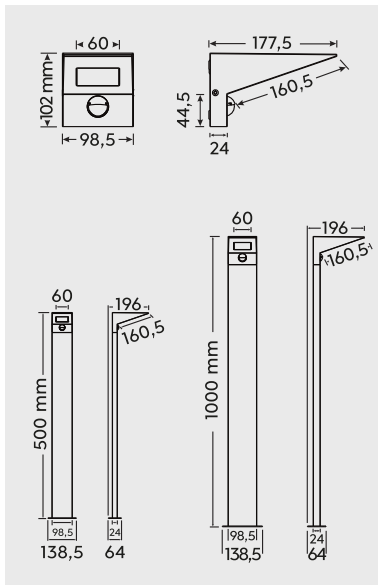

525369142



425369142





225369142



Bewegungssensor
Motion sensor
Décteur de mouvement
Bewegungssensor
Sensor de movimiento
Sensore di movimento
Senzor de mișcare
Liiketunnistin
Czujnik ruchu

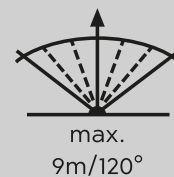

NELSON

Aluminium Druckguss
 diecast aluminium
 fonte d'aluminium
 gegoten aluminium
 aluminio fundido
 pressofusione di alluminio
 fonta aluminiu
 valualumiini
 barwione aluminium

42 Anthrazit · anthracite

Incl. 1 x SMD-LED, 8 W
 850 lm, 3.000 K

IP54

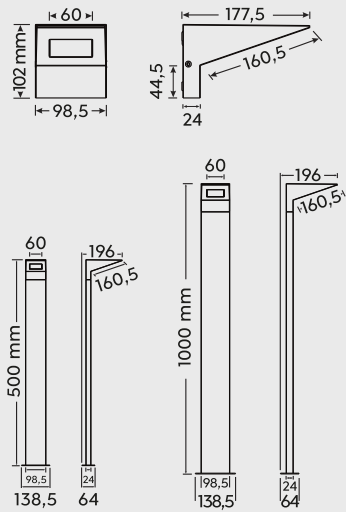

225360142



525360142



425360142





HORTON

Aluminium Druckguss
 diecast aluminium
 fonte d'aluminium
 gegoten aluminium
 aluminio fundido
 pressofusione di alluminio
 fonta aluminiu
 valualumiini
 barwione aluminium

42 Anthrazit · anthracite

Incl. 1 x SMD-LED, 8 W
 1.000 lm, 3.000 K

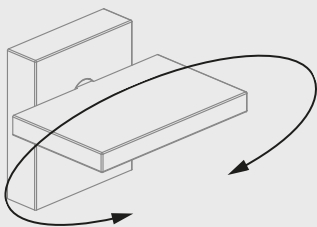
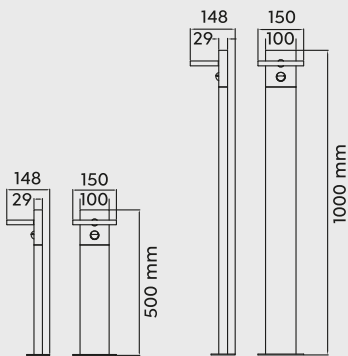
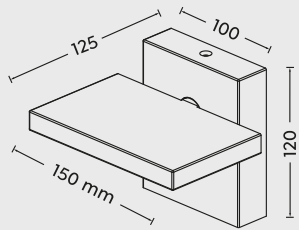

226369142



526369142



426369142



Bewegungssensor
 Motion sensor
 Détecteur de mouvement
 Bewegungssensor
 Sensor de movimiento
 Sensore di movimento
 Senzor de mişcare
 Liiketunnistin
 Czujnik ruchu

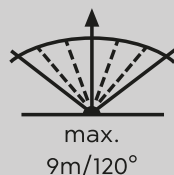



HORTON

Aluminium Druckguss
 diecast aluminium
 fonte d'aluminium
 gegoten aluminium
 aluminio fundido
 pressofusione di alluminio
 fonta aluminii
 valualumiini
 barwione aluminium

42 Anthrazit · anthracite

Incl. 1 x SMD-LED, 8 W
 1.000 lm, 3.000 K

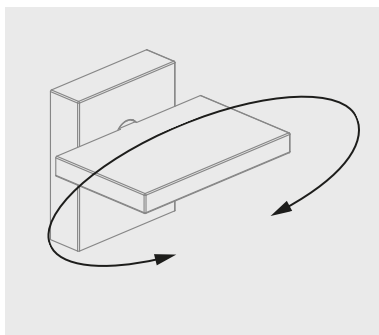
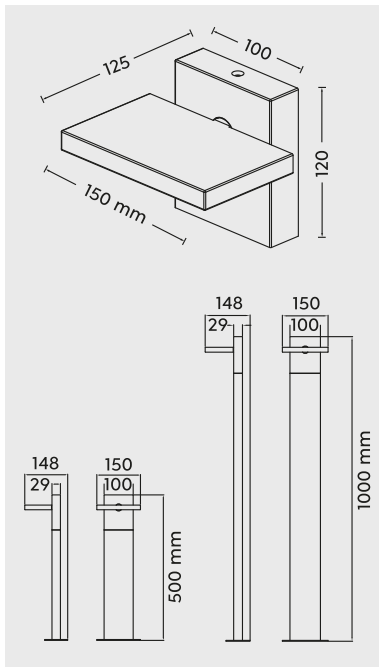

226360142



526360142



426360142

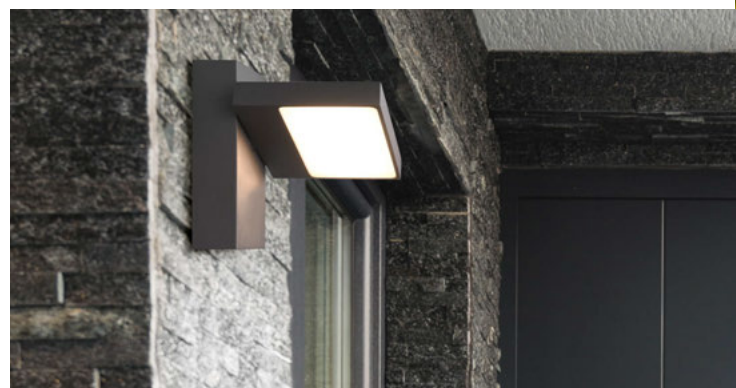



SEINE

Aluminium Druckguss, Kunststoff
diecast aluminium, plastic
fonte d'aluminium, plastique
gegoten aluminium, kunststof
aluminio fundido, plástico
pressofusione di alluminio, plastica
fonta aluminiu, plastic
valualumiini, muovi
barwione aluminium, plastik

42 Anthrazit · anthracite

Incl. 1 x SMD-LED, 6,5 W
750 lm, 3.000 K

IP54



220260142



520260142



420260142

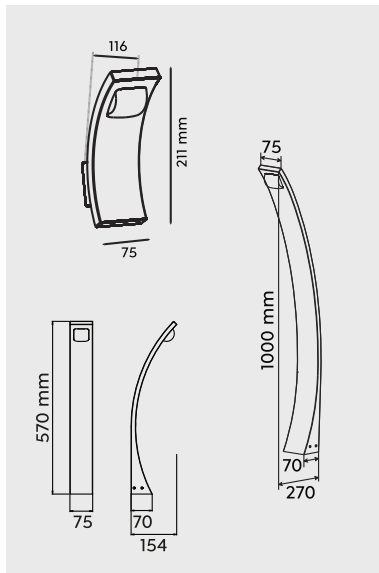



ROYA

Aluminium Druckguss
 diecast aluminium
 fonte d'aluminium
 gegoten aluminium
 aluminio fundido
 pressofusione di alluminio
 fonta aluminiu
 valualumiini
 barwione aluminium

42 Anthrazit · anthracite

Excl. 2 x GU10, max. 35 W

204260242

204269242



Excl. 1 x GU10, max. 35 W

404260142

504260142

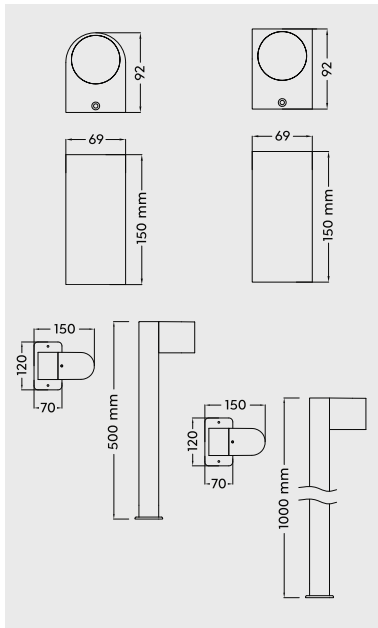

204260242



204269242



504260142



404260142

Empfohlen:
 recommended:

LED GU10, 5 W
 400 lm, 3.000 K
 > 120°



956-5936





KAVERI

Aluminium Druckguss
 diecast aluminium
 fonte d'aluminium
 gegoten aluminium
 aluminio fundido
 pressofusione di alluminio
 fonta aluminii
 valualumiini
 barwione aluminium

42 Anthrazit · anthracite

Excl. 1 x GU10, max. 28 W

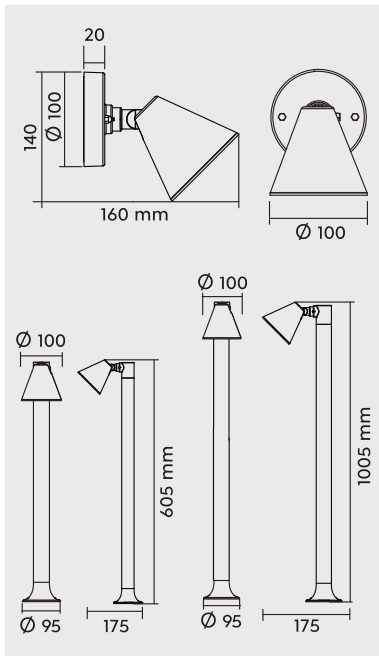

206060142

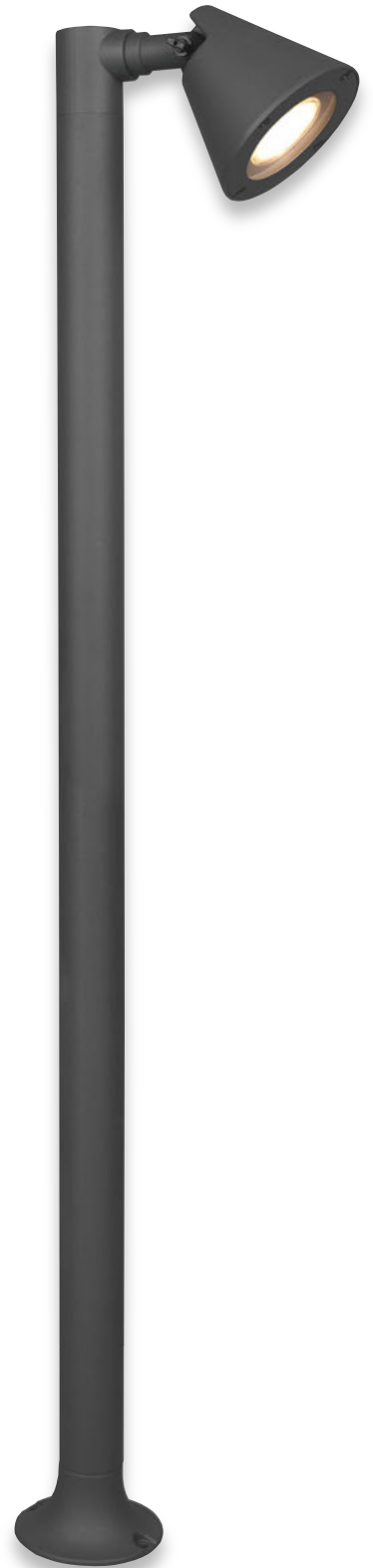

506060142

406060142





COLORADO

Aluminium Druckguss
diecast aluminium
fonte d'aluminium
gegoten aluminium
aluminio fundido
pressofusione di alluminio
fonta aluminiu
valualumiini
barwione aluminium

42 Anthrazit · anthracite

Incl. 2 x SMD-LED, 3 W
2 x 260 lm, 3.000 K

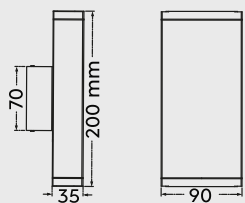

228460242

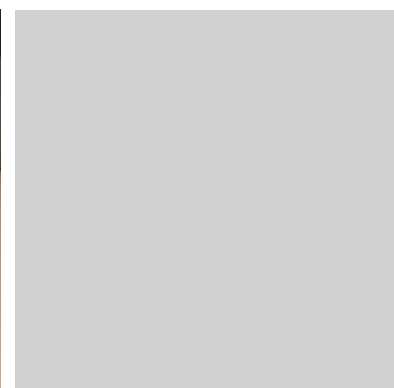
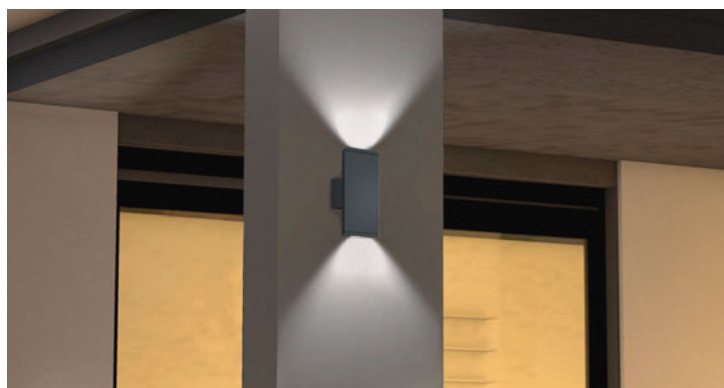

Aluminium Druckguss
diecast aluminium
fonte d'aluminium
gegoten aluminium
aluminio fundido
pressofusione di alluminio
fonta aluminiu
valualumiini
barwione aluminium

42 Anthrazit · anthracite

Incl. 1 x SMD-LED, 7,5 W
800 lm, 3.000 K

IP54

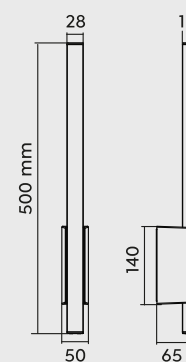

221460142

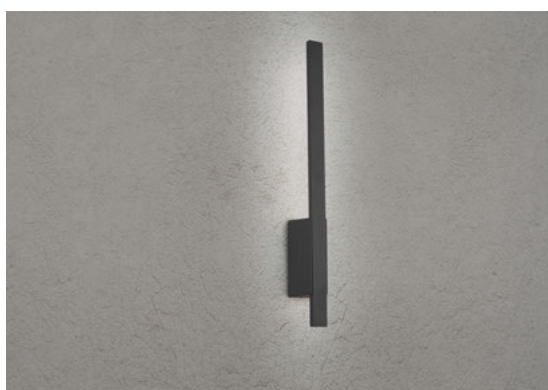

THAMES

Aluminium Druckguss
diecast aluminium
fonte d'aluminium
gegoten aluminium
aluminio fundido
pressofusione di alluminio
fonta aluminiu
valualumiini
barwione aluminium

42 Anthrazit · anthracite

87 titanfarbig · titan

Incl. 2 x SMD-LED, 3 W
2 x 180 lm, 3.000 K

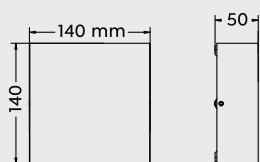

229360242



229360287





THAMES II

Aluminium Druckguss
 diecast aluminium
 fonte d'aluminium
 gegoten aluminium
 aluminio fundido
 pressofusione di alluminio
 fonta aluminiu
 valualumiini
 barwione aluminium

31 Weiß matt · white mat
42 Anthrazit · anthracite
87 titanfarbig · titan

Incl. 2 x SMD-LED, 2,5 W
 2 x 260 lm, 3.000 K

227560231
227560242
227560287



Incl. 2 x SMD-LED, 4,5 W
 2 x 400 lm, 3.000 K

227660231
227660242
227660287

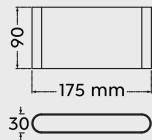
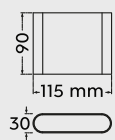

227560231



227560242



227560287



227660231



227660242



227660287

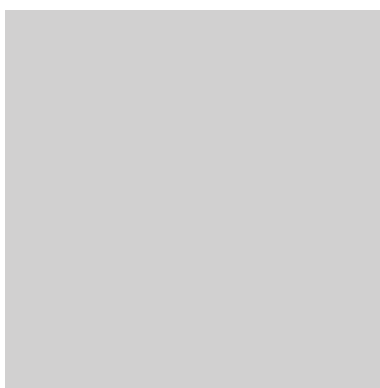
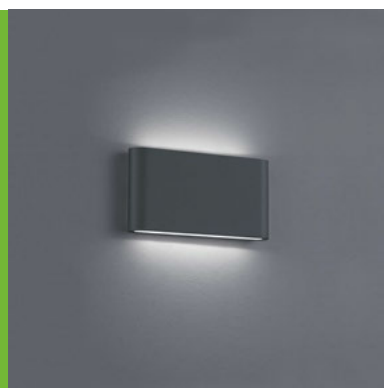

THAMES II



Aluminium Druckguss
diecast aluminium
fonte d'aluminium
gegooten aluminium
aluminio fundido
pressofusione di alluminio
fonta aluminiu
valualumiini
barwione aluminium

31 Weiß matt · white mat
42 Anthrazit · anthracite
87 titanfarbig · titan

Incl. 2 x SMD-LED, 8 W
2 x 800 lm, 3.000 K

226460231
226460242
226460287

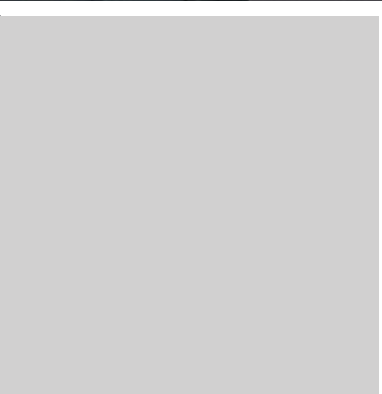
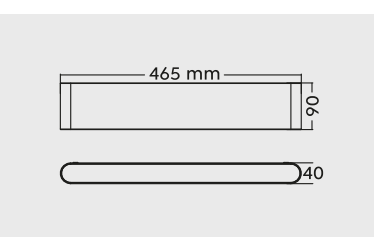

TRENT

Aluminium Druckguss
diecast aluminium
fonte d'aluminium
gegoten aluminium
aluminio fundido
pressofusione di alluminio
fonta aluminu
valualumiini
barwione aluminium

31 Weiß matt · white mat

42 Anthrazit · anthracite

87 titanfarbig · titan

Incl. SMD-LED, 10 W
800 lm, 3.000 K

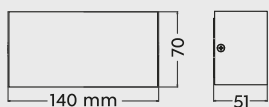

226960231

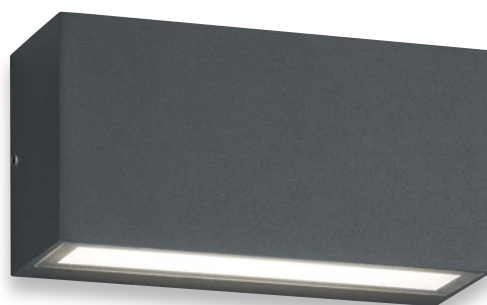

226960242

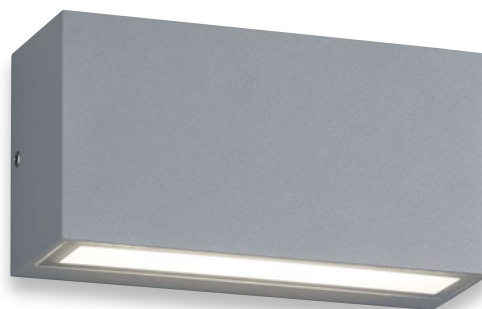

226960287

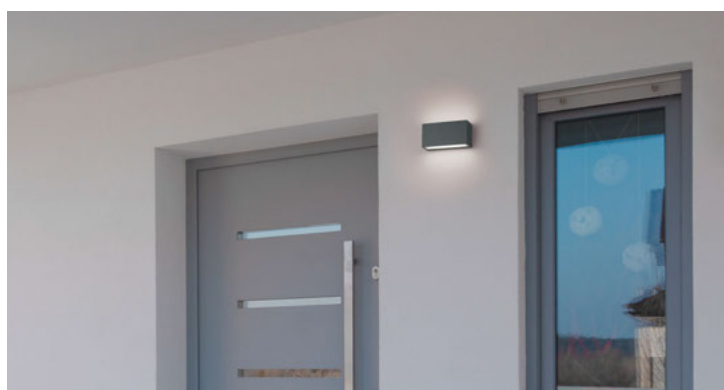

Aluminium Druckguss
 diecast aluminium
 fonte d'aluminium
 gegoten aluminium
 aluminio fundido
 pressofusione di alluminio
 fonta aluminiu
 valualumiini
 barwione aluminium

42 Anthrazit · anthracite

Incl. 2 x SMD-LED, 4,5 W
 2 x 450 lm, 3.000 K

IP65



226560242

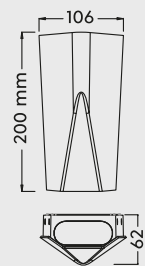

ADAJA

Aluminium Druckguss
diecast aluminium
fonte d'aluminium
gegoten aluminium
aluminio fundido
pressofusione di alluminio
fonta aluminii
valualumiini
barwione aluminium

31 Weiß matt · white mat
42 Anthrazit · anthracite
87 titanfarbig · titan

Incl. 2 x SMD-LED, 3 W
2 x 240 lm, 3.000 K

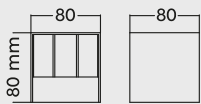

226860231



226860242



226860287

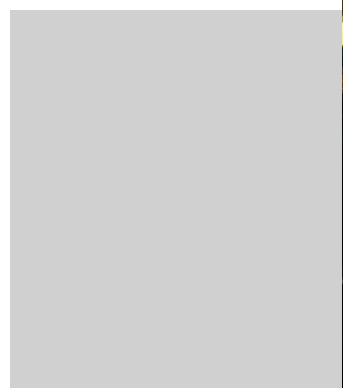
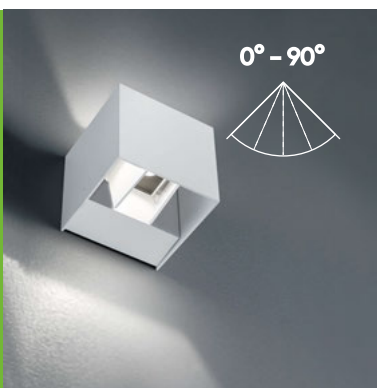



SACRAMENTO

Aluminium Druckguss
diecast aluminium
fonte d'aluminium
gegoten aluminium
aluminio fundido
pressofusione di alluminio
fonta aluminiu
valualumiini
barwione aluminium

31 Weiß matt · white mat

42 Anthrazit · anthracite

Incl. 1 x SMD-LED, 2 W
200 lm, 3.000 K

Incl. 1 x SMD-LED, 5,5 W
550 lm, 3.000 K

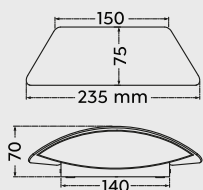

227860231



227860242

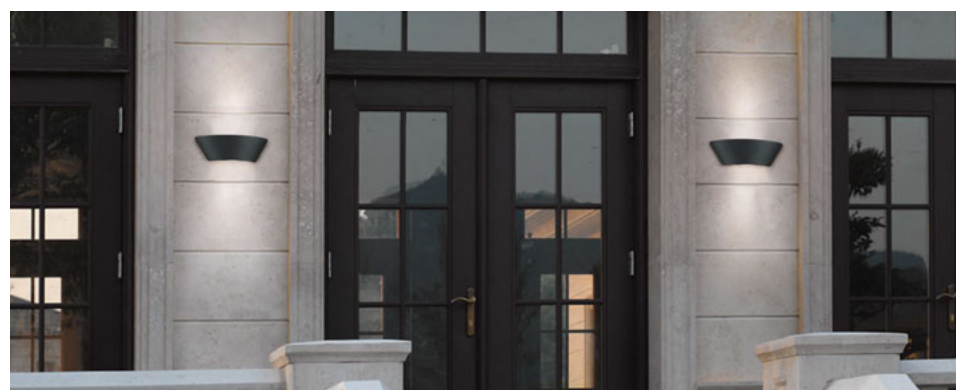

KONDA



228560242

Aluminium Druckguss, Kunststoff
diecast aluminium, plastic
fonte d'aluminium, plastique
gegoten aluminium, kunststof
aluminio fundido, plástico
pressofusione di alluminio, plastica
fonta aluminiu, plastic
valualumiini, muovi
barwione aluminium, plastik

42 Anthrazit · anthracite

Incl. 1 x SMD-LED, 9 W
850 lm, 3.000 K

IP65

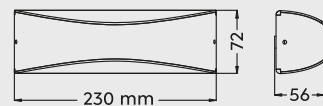

HARLEM

Aluminium Druckguss, Kunststoff
diecast aluminium, plastic
fonte d'aluminium, plastique
gegoten aluminium, kunststof
aluminio fundido, plástico
pressofusione di alluminio, plastica
fonta aluminiu, plastic
valualumiini, muovi
barwione aluminium, plastik

42 Anthrazit · anthracite

87 titanfarbig · titan

Incl. 1 x SMD-LED, 6 W
580 lm, 3.000 K

IP54

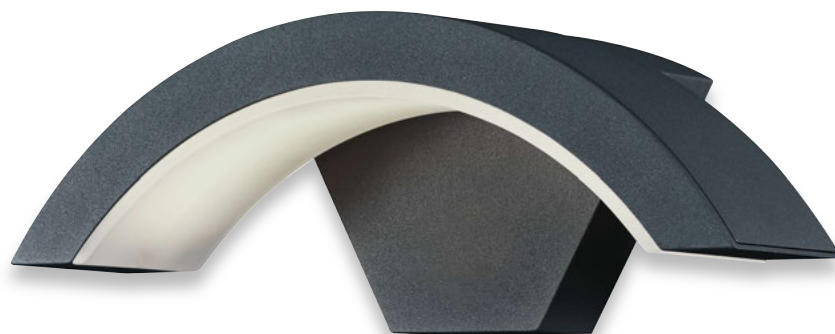
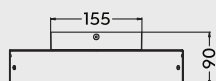
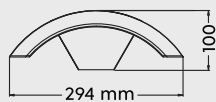

220960142

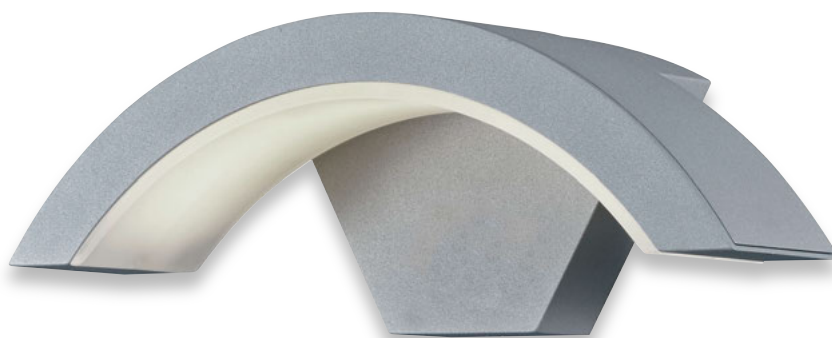

220960187

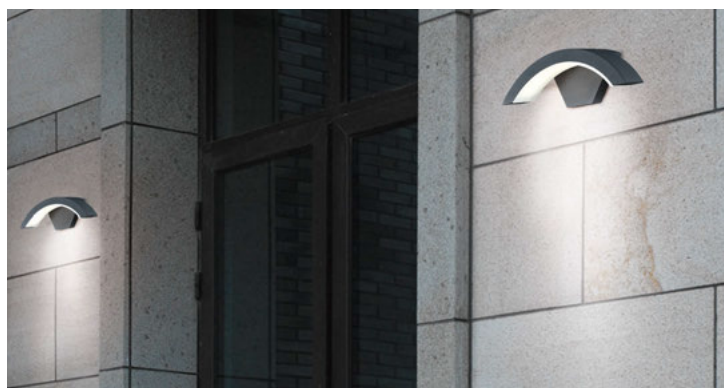

OHIO

Aluminium Druckguss, Kunststoff
diecast aluminium, plastic
fonte d'aluminium, plastique
gegoten aluminium, kunststof
aluminio fundido, plástico
pressofusione di alluminio, plastica
fonta aluminiu, plastic
valualumiini, muov
barwione aluminium, plastik

42 Anthrazit · anthracite

87 titanfarbig · titan

Incl. 1 x SMD-LED, 6 W
580 lm, 3.000 K



220969187

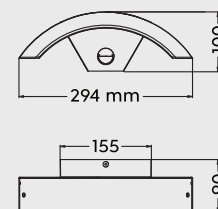

220969142



Bewegungssensor
Motion sensor
Décteur de mouvement
Bewegingssensor
Sensor de movimiento
Sensore di movimento
Senzor de mişcare
Liiketunnistin
Czujnik ruchu

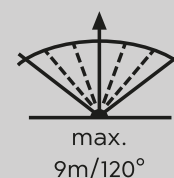

TRAVE

Aluminium Druckguss, Kunststoff
diecast aluminium, plastic
fonte d'aluminium, plastique
gegoten aluminium, kunststof
aluminio fundido, plástico
pressofusione di alluminio, plastica
fonta aluminiu, plastic
valualumiini, muovi
barwione aluminium, plastik

01 Weiß · white

42 Anthrazit · anthracite

Incl. 1 x SMD-LED, 6,5 W
700 lm, 3.000 K

IP54

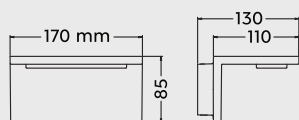

228760101



228760142

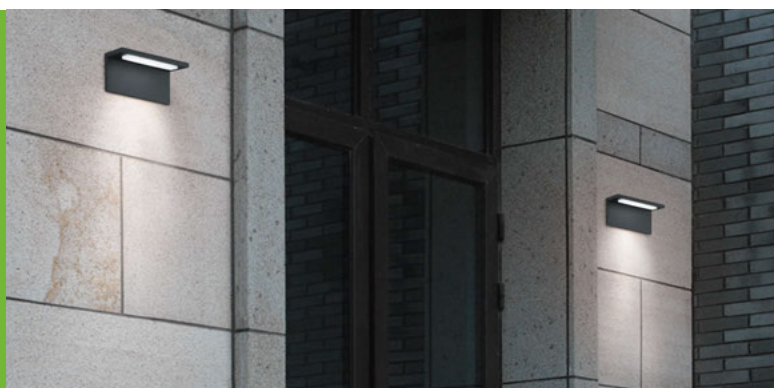

TRAVE

Aluminium Druckguss, Kunststoff
diecast aluminium, plastic
fonte d'aluminium, plastique
gegoten aluminium, kunststof
aluminio fundido, plástico
pressofusione di alluminio, plastica
fonta aluminiu, plastic
valualumiini, muovi
barwione aluminium, plastik

42 Anthrazit · anthracite

Incl. SMD-LED, 18 W
1.750 lm, 3.000 K

IP54

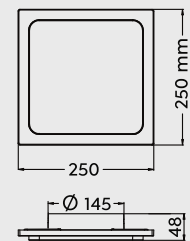

620160142



CUANDO

Aluminium Druckguss, Acryl
diecast aluminium, acryl
fonte d'aluminium, acryl
gegoten aluminium, acryl
aluminio fundido, acrílico
pressofusione di alluminio, acrilico
fonta aluminiu, acrilic
valualumiini, akryyli
barwione aluminium, akryl

42 Anthrazit · anthracite

Incl. SMD-LED, 14 W
1.000 lm, 3.000 K

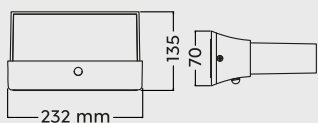
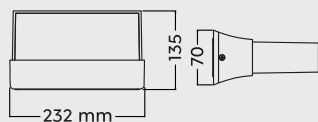

226660242



226669242

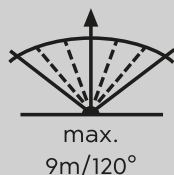
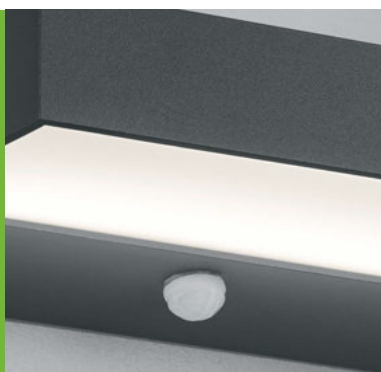

Bewegungssensor
Motion sensor
Détecteur de mouvement
Bewegingssensor
Sensor de movimiento
Sensore di movimento
Senzor de mişcare
Liiketunnistin
Czujnik ruchu

INDUS

Aluminium Druckguss, Kunststoff
diecast aluminium, plastic
fonte d'aluminium, plastique
gegoten aluminium, kunststof
aluminio fundido, plástico
pressofusione di alluminio, plastica
fonta aluminiu, plastic
valualumiini, muovi
barwione aluminium, plastik

42 Anthrazit · anthracite

Incl. 1 x SMD-LED, 8,5 W
850 lm, 3.000 K

IP54

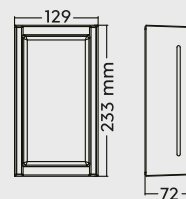

227360142



YANGTZE

Aluminium Druckguss, Kunststoff
diecast aluminium, plastic
fonte d'aluminium, plastique
gegoten aluminium, kunststof
aluminio fundido, plástico
pressofusione di alluminio, plastica
fonta aluminiu, plastic
valualumiini, muovi
barwione aluminium, plastik

01 Weiß · white

42 Anthrazit · anthracite

Incl. 1 x SMD-LED, 3,5 W
330 lm, 3.000 K

IP54

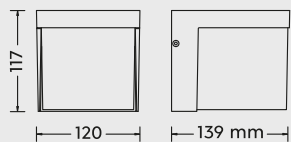

228260101



228260142

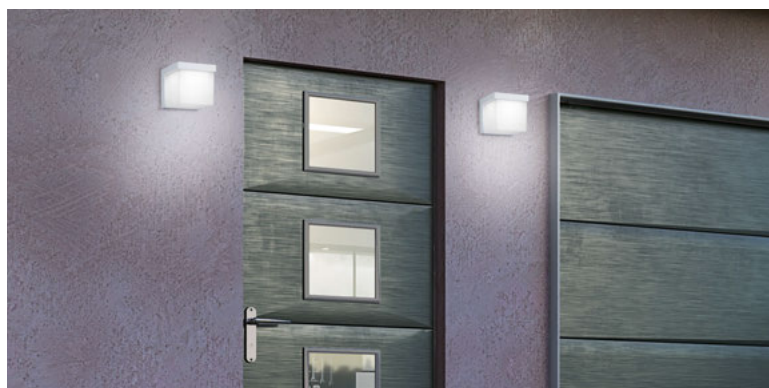

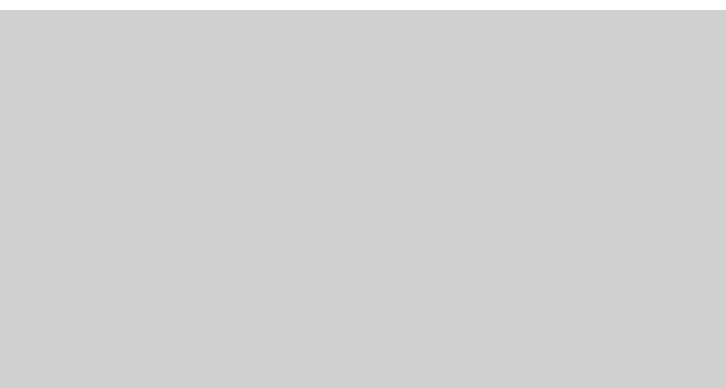

TIBER

Aluminium Druckguss
diecast aluminium
fonte d'aluminium
gegoten aluminium
aluminio fundido
pressofusione di alluminio
fonta aluminiu
valualumiini
barwione aluminium

42 Anthrazit · anthracite

Incl. 1 x COB-LED, 3 W
210 lm, 3.000 K

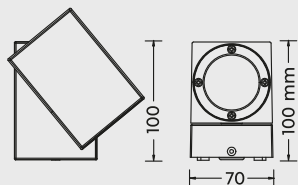

229160142

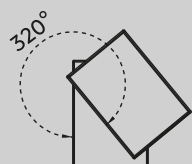

PADMA

Aluminium Druckguss
diecast aluminium
fonte d'aluminium
gegoten aluminium
aluminio fundido
pressofusione di alluminio
fonta aluminiu
valualumiini
barwione aluminium

42 Anthrazit · anthracite

Incl. 2 x SMD-LED, 4,5 W
2 x 420 lm, 3.000 K



227160242

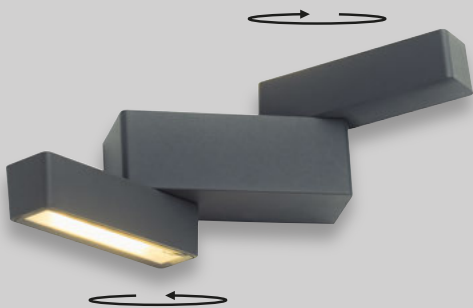
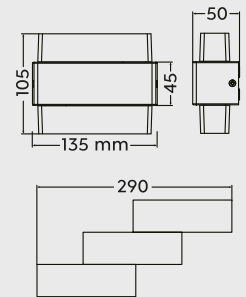

Schwenkbar
Tiltable
Pivotant
Draaibaar
Pivotante
Girevole
Pivotant
Suunnattava
Skreṭny



TUNGA

Aluminium Druckguss
 diecast aluminium
 fonte d'aluminium
 gegoten aluminium
 aluminio fundido
 pressofusione di alluminio
 fonta aluminiu
 valualumiini
 barwione aluminium

31 Weiß matt · white mat
42 Anthrazit · anthracite

Incl. 1 x SMD-LED, 3,5 W
 420 lm, 3.000 K

222969131
222969142



Incl. 2 x SMD-LED, 3,5 W
 2 x 420 lm, 3.000 K

222969231
222969242



222969131



222969142

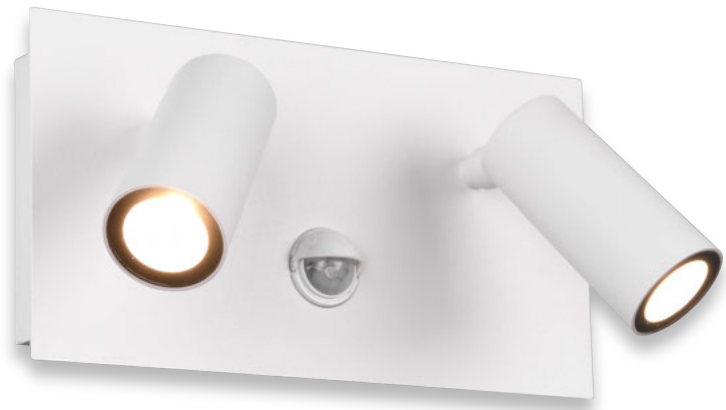

222969231

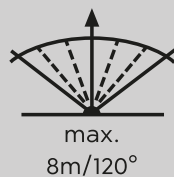
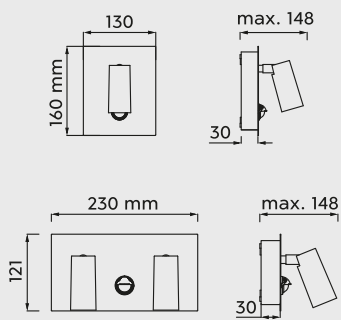

Bewegungssensor
 Motion sensor
 Détecteur de mouvement
 Bewegungssensor
 Sensor de movimiento
 Sensore di movimento
 Senzor de mişcare
 Liiketunnistin
 Czujnik ruchu

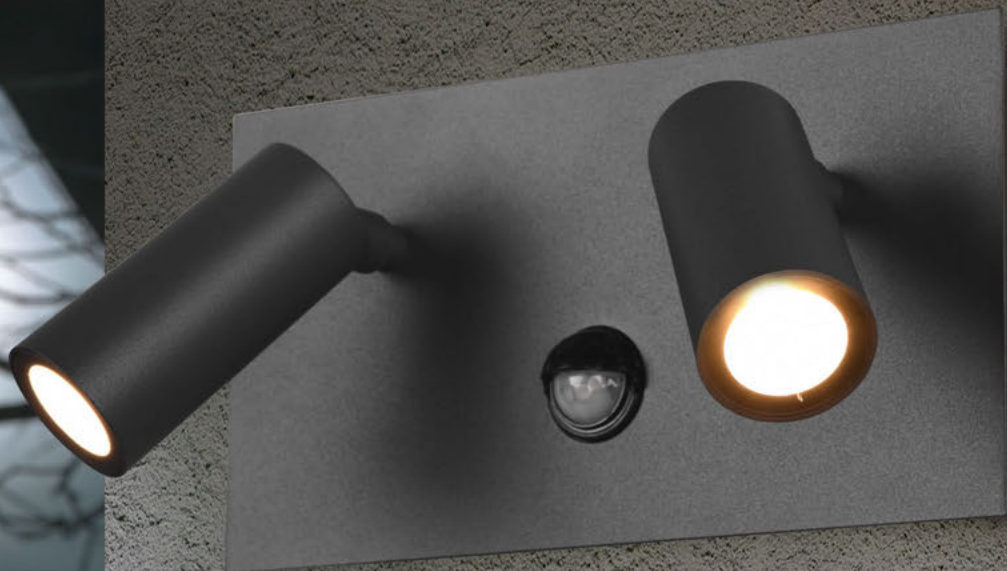

222969242

TUNGA

Aluminium Druckguss
diecast aluminium
fonte d'aluminium
gegoten aluminium
aluminio fundido
pressofusione di alluminio
fonta aluminiu
valualumiini
barwione aluminium

31 Weiß matt · white mat
42 Anthrazit · anthracite

Incl. 1 x SMD-LED, 3,5 W
420 lm, 3.000 K

222960131
222960142

IP54

Incl. 2 x SMD-LED, 3,5 W
2 x 420 lm, 3.000 K

222960231
222960242

IP54



222960131



222960142

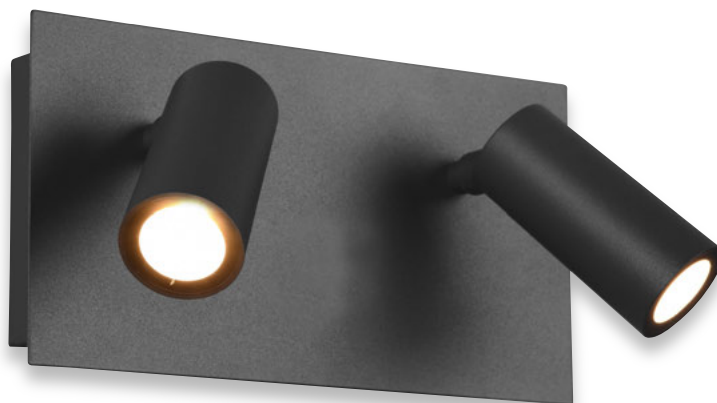

222960242

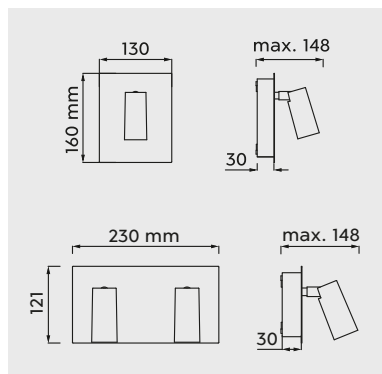



222960231

MUGA

Aluminium Druckguss, Kunststoff
diecast aluminium, plastic
fonte d'aluminium, plastique
gegoten aluminium, kunststof
aluminio fundido, plástico
pressofusione di alluminio, plastica
fonta aluminu, plastic
valualumiini, muovi
barwione aluminium, plastik

01 Weiß · white

42 Anthrazit · anthracite

Incl. 1 x SMD-LED, 5 W
550 lm, 3.000 K

IP54

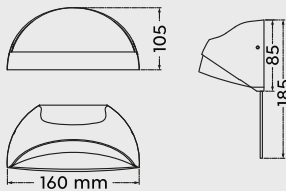

228360142



228360101





20

PECOS

Aluminium Druckguss, Kunststoff
diecast aluminium, plastic
fonte d'aluminium, plastique
gegoten aluminium, kunststof
aluminio fundido, plástico
pressofusione di alluminio, plastica
fonta aluminiu, plastic
valualumiini, muovi
barwione aluminium, plastik

42 Anthrazit · anthracite

Incl. 1 x SMD-LED, 6 W
600 lm, 3.000 K

IP54

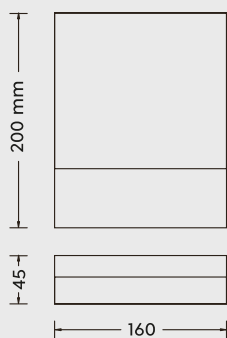

227760142



KASAI

Aluminium Druckguss, Kunststoff
diecast aluminium, plastic
fonte d'aluminium, plastique
gegoten aluminium, kunststof
aluminio fundido, plástico
pressofusione di alluminio, plastica
fonta aluminiu, plastic
valualumiini, muovi
barwione aluminium, plastik

42 Anthrazit · anthracite

Incl. 1 x SMD-LED, 9 W
850 lm, 3.000 K

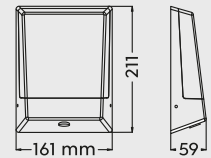

228669142



Dämmerungssensor
Dusk sensor
Décteur de crépuscule
Schemeringsensor
Sensor de oscuridad
Sensore crepuscolare
Senzor de lumina/amurg
Hämärätunnistin
Czujnik zmierzchowy
Alacakaranlık Algılayıcısı



TIMOK

Aluminium Druckguss, Kunststoff
diecast aluminium, plastic
fonte d'aluminium, plastique
gegoten aluminium, kunststof
aluminio fundido, plástico
pressofusione di alluminio, plastica
fonta aluminiu, plastic
valualumiini, muovu
barwione aluminium, plastik

01 Weiß · white

42 Anthrazit · anthracite

Incl. 1 x LED E27, 5 W
470 lm, 3.000 K

IP54

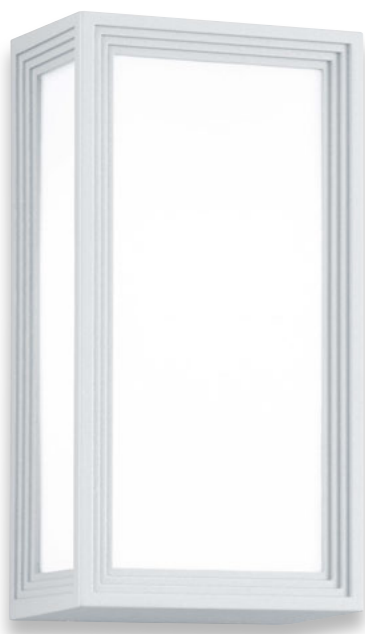
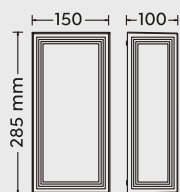

228060101



228060142

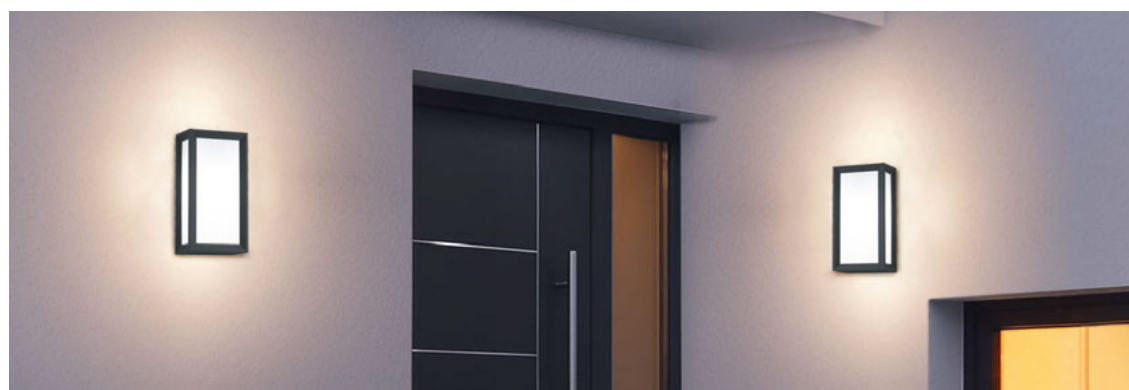

HONDO



228960101

Aluminium Druckguss, Kunststoff
diecast aluminium, plastic
fonte d'aluminium, plastique
gegoten aluminium, kunststof
aluminio fundido, plástico
pressofusione di alluminio, plastica
fonta aluminiu, plastic
valualumiini, muovi
barwione aluminium, plastik

01 Weiß · white

42 Anthrazit · anthracite

Incl. 1 x SMD-LED, 3,5 W
330 lm, 3.000 K

IP54

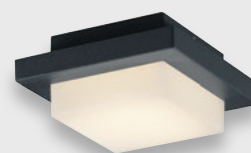
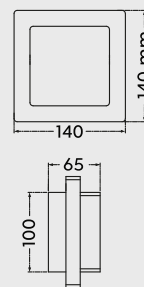

228960142

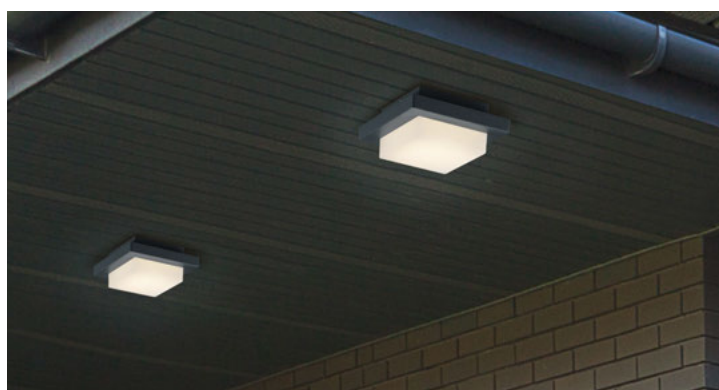

BREG

Aluminium Druckguss, Kunststoff
diecast aluminium, plastic
fonte d'aluminium, plastique
gegoten aluminium, kunststof
aluminio fundido, plástico
pressofusione di alluminio, plastica
fonta aluminiu, plastic
valualumiini, muovi
barwione aluminium, plastik

42 Anthrazit · anthracite

Incl. 1 x SMD-LED, 8,5 W
850 lm, 3.000 K

IP54

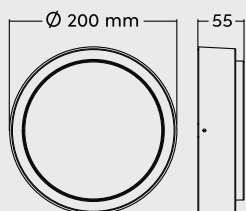

227260142



PEDRO

Aluminium Druckguss, Acryl
diecast aluminium, acryl
fonte d'aluminium, acryl
gegoten aluminium, acryl
aluminio fundido, acrílico
pressofusione di alluminio, acrilico
fonta aluminiu, acrilic
valualumiini, akryyli
barwione aluminium, akryl

42 Anthrazit · anthracite

Incl. 1 x SMD-LED, 9 W
1.000 lm, 3.000 K

IP54

222860142

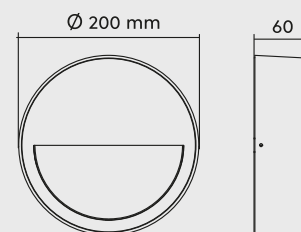

PIAVE

Kunststoff
plastic
plastique
kunststof
plástico
plastica
plastic
muovi
plastik

31 Weiß matt · white mat

42 Anthrazit · anthracite

Incl. SMD-LED, 12 W
1.000 lm, 3.000 K

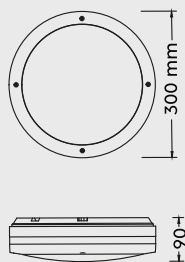

676960131



676960142

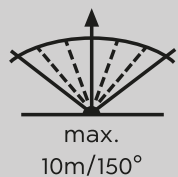

Bewegungssensor
Motion sensor
Détecteur de mouvement
Bewegingssensor
Sensor de movimiento
Sensore di movimento
Senzor de mişcare
Liiketunnistin
Czujnik ruchu





MURRAY

Kunststoff
plastic
plastique
kunststof
plástico
plastica
plastic
muovi
plastik

24 rostfarbig · rusty

78 betonfarbig · concrete look

Excl. 2 x E27, max. 12 W



IP54

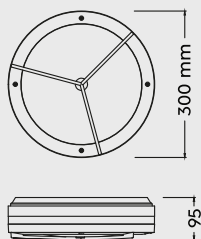

676160224



676160278

Empfohlen:
recommended:

LED E27, 6 W
470 lm, 3.000 K



987-60

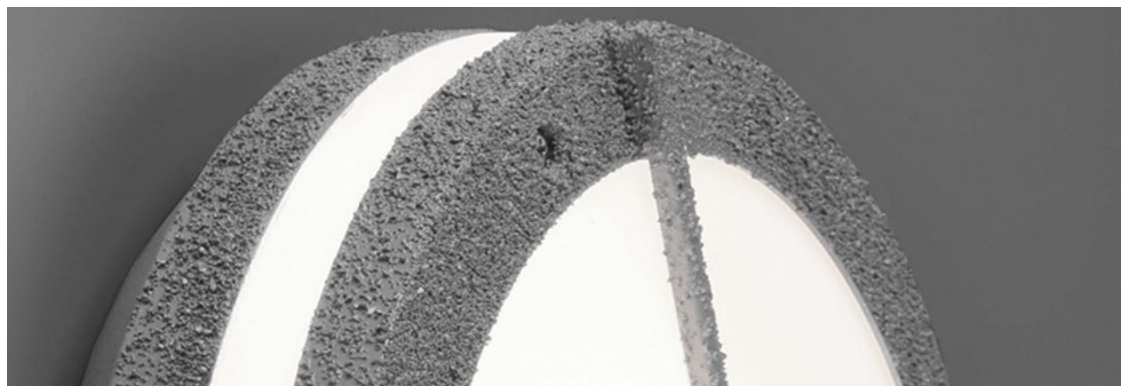



HOOSIC

Aluminium Druckguss, Kunststoff
 diecast aluminium, plastic
 fonte d'aluminium, plastique
 gegoten aluminium, kunststof
 aluminio fundido, plástico
 pressofusione di alluminio, plastica
 fonta aluminiu, plastic
 valualumiini, muovi
 barwione aluminium, plastik

24 rostfarbig · rusty

Excl. 1 x E27, max. 28 W

222260124

422260124

522260124

Excl. 2 x E27, max. 28 W

222260224



IP44



222260124



222260224



522260124



422260124

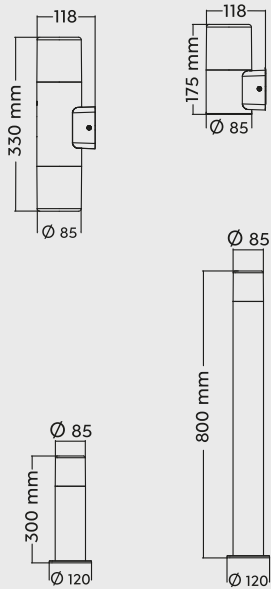

Empfohlen:
 recommended:

Filament LED
 E27, 6 W
 470 lm, 3.000 K



987-60

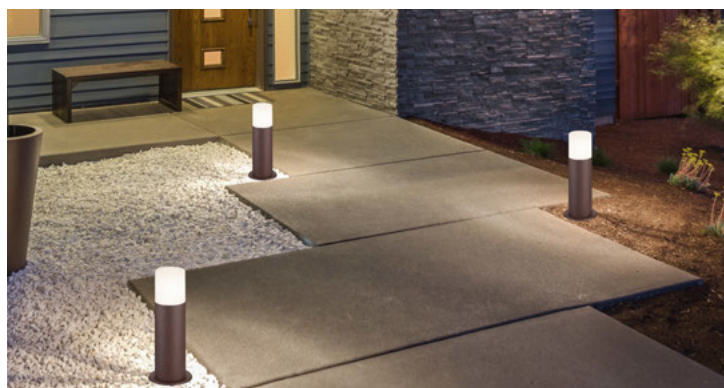



HOOSIC

Aluminium Druckguss, Kunststoff
 diecast aluminium, plastic
 fonte d'aluminium, plastique
 gegoten aluminium, kunststof
 aluminio fundido, plástico
 pressofusione di alluminio, plastica
 fonta aluminiu, plastic
 valualumiini, muovi
 barwione aluminium, plastik

42 Anthrazit · anthracite

Excl. 1 x E27, max. 28 W

222260142

422260142

522260142

Excl. 2 x E27, max. 28 W

222260242



222260142



222260242



522260142



422260142

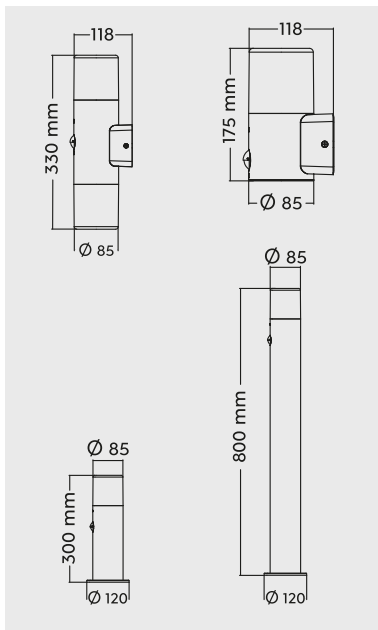

Empfohlen:
 recommended:

Filament LED
 E27, 6 W
 470 lm, 3.000 K



987-60



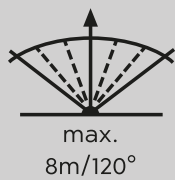

Bewegungssensor
Motion sensor
Détecteur de mouvement
Bewegungssensor
Sensor de movimiento
Sensore di movimento
Senzor de mișcare
Liiketunnistin
Czujnik ruchu



HOOSIC

Aluminium Druckguss, Kunststoff
 diecast aluminium, plastic
 fonte d'aluminium, plastique
 gegoten aluminium, kunststof
 aluminio fundido, plástico
 pressofusione di alluminio, plastica
 fonta aluminiu, plastic
 valualumiini, muovi
 barwione aluminium, plastik

42 Anthrazit · anthracite

Excl. 1 x E27, max. 28 W

224060142

424060142

524060142

Excl. 2 x E27, max. 28 W

224060242



224060142



224060242



424060142



524060142

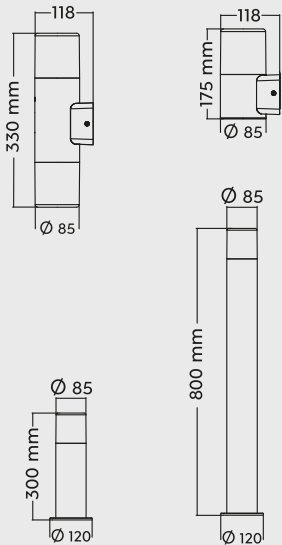

Empfohlen:
 recommended:

Filament LED
 E27, 6 W
 470 lm, 3.000 K



987-60



HOOSIC

Aluminium Druckguss, Kunststoff
diecast aluminium, plastic
fonte d'aluminium, plastique
gegoten aluminium, kunststof
aluminio fundido, plástico
pressofusione di alluminio, plastica
fonta aluminiu, plastic
valualumiini, muovi
barwione aluminium, plastik

42 Anthrazit · anthracite

Excl. 1 x E27, max. 28 W



IP44



424067142



HUDSON

Aluminium Druckguss, Kunststoff
 diecast aluminium, plastic
 fonte d'aluminium, plastique
 gegoten aluminium, kunststof
 aluminio fundido, plástico
 pressofusione di alluminio, plastica
 fonta aluminiu, plastic
 valualumiini, muov
 barwione aluminium, plastik

42 Anthrazit · anthracite

Incl. 1 x LED E14, 4 W
 320 lm, 3.000 K

220060142

420060142

520060142

Incl. 2 x LED E14, 4 W
 2 x 320 lm, 3.000 K

220060242

IP44



220060142



220060242



520060142



420060142

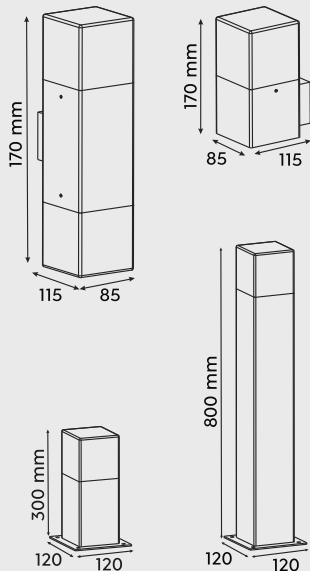

Incl. LED E14, 4 W
 320 lm, 3.000 K



983-40

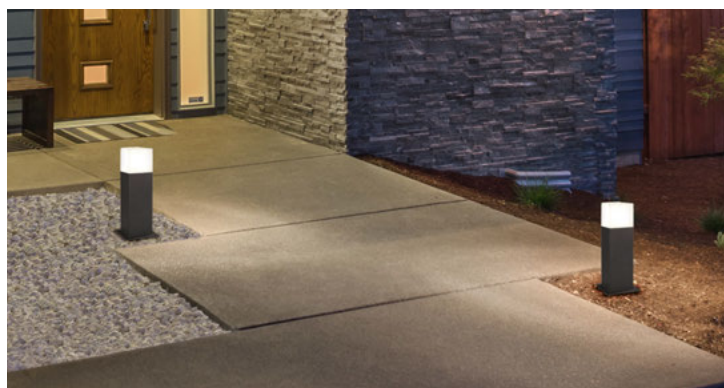



HUDSON

Aluminium Druckguss, Kunststoff
 diecast aluminium, plastic
 fonte d'aluminium, plastique
 gegoten aluminium, kunststof
 aluminio fundido, plástico
 pressofusione di alluminio, plastica
 fonta aluminiu, plastic
 valualumiini, muovi
 barwione aluminium, plastik

87 titanfarbig · titan

Incl. 1 x LED E14, 4 W
 320 lm, 3.000 K

220060187

420060187

520060187

Incl. 2 x LED E14, 4 W
 2 x 320 lm, 3.000 K

220060287

IP44

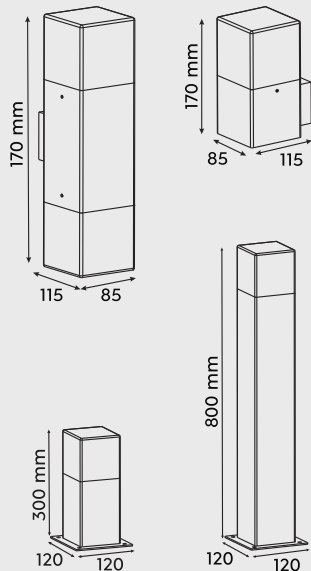

220060187



220060287



520060187



420060187

Incl. LED E14, 4 W
 320 lm, 3.000 K



983-40





CUBANGO

Aluminium Druckguss, Kunststoff
 diecast aluminium, plastic
 fonte d'aluminium, plastique
 gegoten aluminium, kunststof
 aluminio fundido, plástico
 pressofusione di alluminio, plastica
 fonta aluminiu, plastic
 valualumiini, muov
 barwione aluminium, plastik

42 Anthrazit · anthracite

Incl. 1 x LED E27, 5 W
 400 lm, 3.000 K

IP54

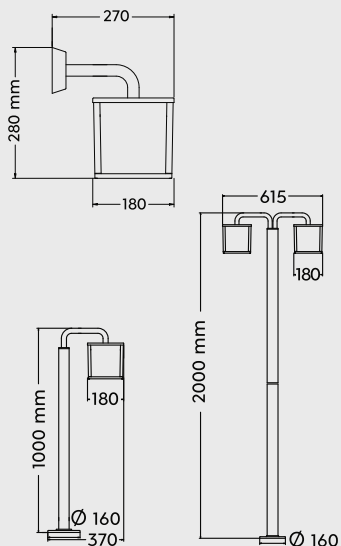

221560142



421560142



421560242

Incl. LED E27, 5 W
 400 lm, 3.000 K



986-60





DONEZ

Aluminium Druckguss, Glas
diecast aluminium, glass
fonte d'aluminium, verre
gegoten aluminium, glas
aluminio fundido, vidrio
pressofusione di alluminio, vetro
fonta aluminiu, sticla
valualumiini, lasi
barwione aluminium, szkło

42 Anthrazit · anthracite

Excl. 1 x E27, max. 40 W

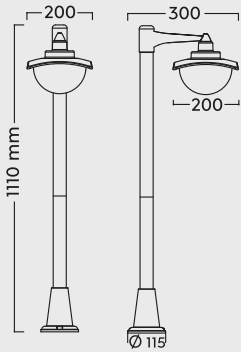
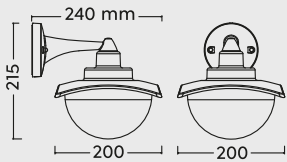

204960142



404960142

Empfohlen:
recommended:

LED E27, 5 W
400 lm, 3.000 K



986-60

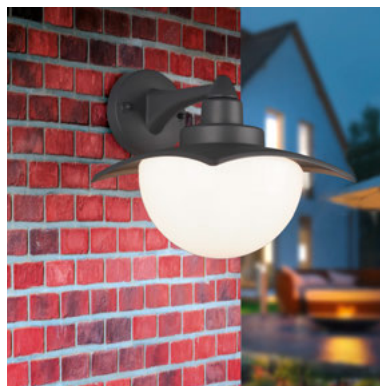



KONGO

Aluminium Druckguss, Kunststoff
diecast aluminium, plastic
fonte d'aluminium, plastique
gegoten aluminium, kunststof
aluminio fundido, plástico
pressofusione di alluminio, plastica
fonta aluminiu, plastic
valualumiini, muovi
barwione aluminium, plastik

42 Anthrazit · anthracite

Incl. 1 x LED E27, 5 W
400 lm, 3.000 K

IP44

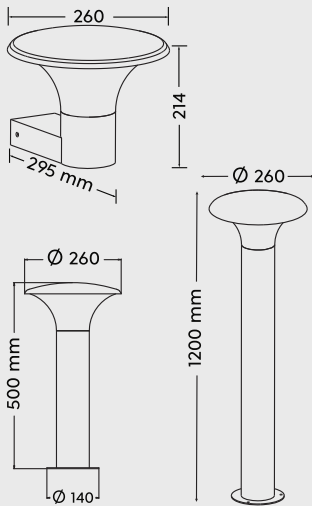

220160142



420160142



520160142

Incl. LED E27, 5 W
400 lm, 3.000 K



986-60



AMUR

Aluminium Druckguss, Kunststoff
diecast aluminium, plastic
fonte d'aluminium, plastique
gegoten aluminium, kunststof
aluminio fundido, plástico
pressofusione di alluminio, plastica
fonta aluminiu, plastic
valualumiini, muovi
barwione aluminium, plastik

31 Weiß matt · white mat

88 Silber antik · antique silver

Excl. 1 x E27, max. 60 W



IP44

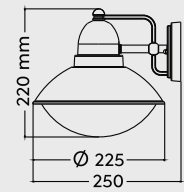

227460188



227460131

Empfohlen:
recommended:

LED E27, 6 W
470 lm, 3.000 K



987-60

NORMAN

Aluminium Druckguss, Acryl
diecast aluminium, acryl
fonte d'aluminium, acryl
gegoten aluminium, acryl
aluminio fundido, acrílico
pressofusione di alluminio, acrilico
fonta aluminiu, acrilic
valualumiini, akryyli
barwione aluminium, akryl

24 rostfarbig · rusty
31 Weiß matt · white mat
42 Anthrazit · anthracite

Excl. 1 x E27, max. 40 W

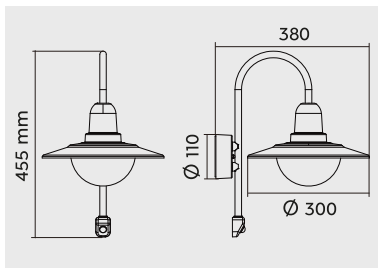

207269131



207269142

Empfohlen:
recommended:

LED E27, 6 W
470 lm, 3.000 K



987-60

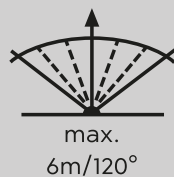

max.
6m/120°



Bewegungssensor
Motion sensor
Détecteur de mouvement
Bewegingssensor
Sensor de movimiento
Sensore di movimento
Senzor de mişcare
Liiketunnistin
Czujnik ruchu



207269124

COOPER

Edelstahl, Kunststoff
steel, plastic
acier, plastique
staal, kunststof
acero, plástico
acciaio, plastica
inox, plastic
teräs, muovi
stal, plastik

42 Anthrazit · anthracite

Excl. 1 x E27, max. 40 W



IP44

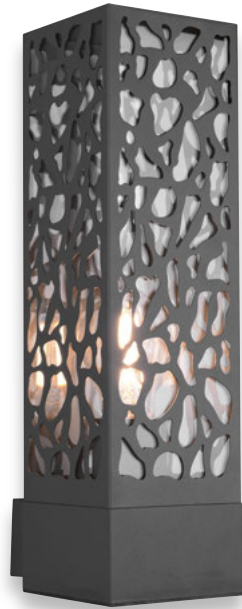

207360142

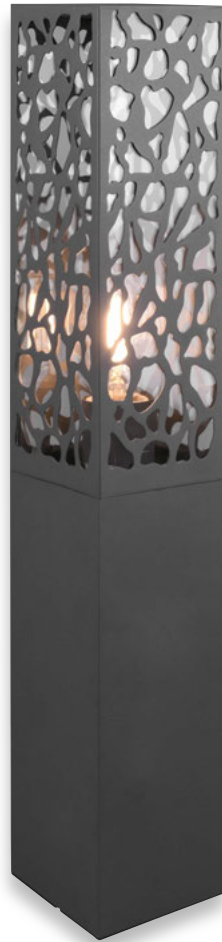

507360142



407360142

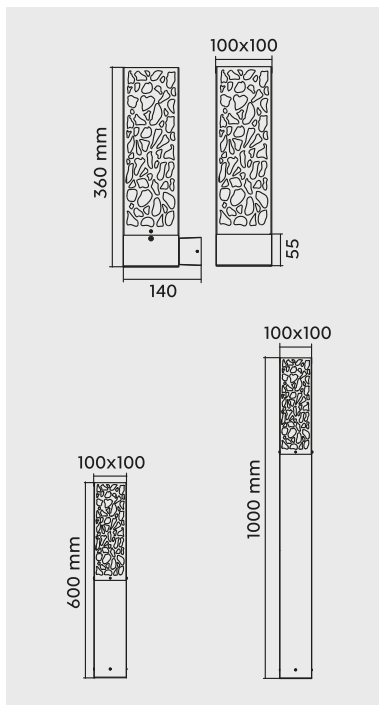

Empfohlen:
recommended:

LED E27, 6 W
470 lm, 3.000 K



987-400





CANNING

Aluminium Druckguss, Naturholz
 diecast aluminium, natural wood
 fonte d'aluminium, bois naturel
 gegoten aluminium, natuur hout
 aluminio fundido, madera natural
 pressofusione di alluminio, legno naturale
 fonta aluminiu, lemn natural
 valualumiini, luonnonpuu
 barwione aluminium, drewno naturalne

30 holzfarbig / Anthrazit ·
 wood coloured / anthracite

Excl. 1 x GU10, max. 28 W



IP44

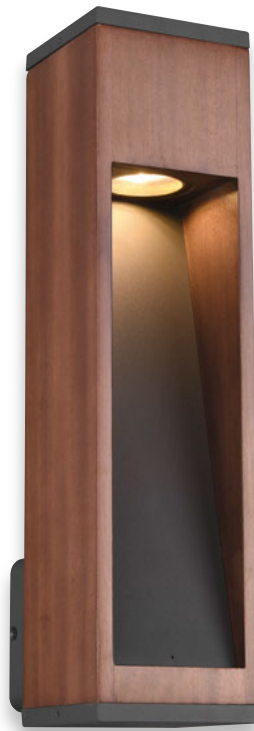

209660130



409660130

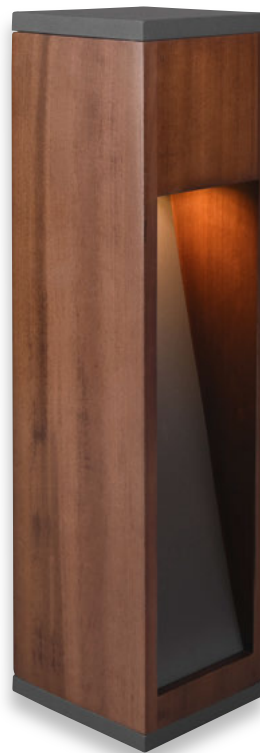

509660130

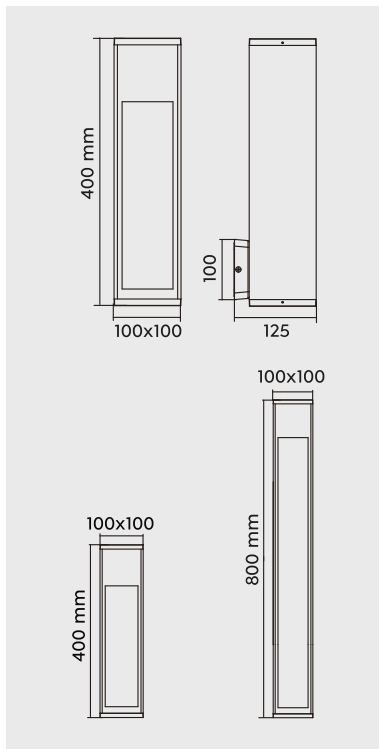

Empfohlen:
 recommended:

LED GU10, 5 W
 400 lm, 3.000 K
 ≥ 120°



955-50





GARONNE

Aluminium Druckguss,
Naturholz, Glas
diecast aluminium,
natural wood, glass
fonte d'aluminium,
bois naturel, verre
gegooten aluminium,
natuur hout, glas
aluminio fundido,
madera natural, vidrio
pressofusione di alluminio,
legno naturale, vetro
fonta aluminiu,
lemn natural, sticla
valualumiini,
luonnonpuu, lasi
barwione aluminium,
drewno naturalne, szkło

30 holzfarbig / Anthrazit ·
wood coloured / anthracite

Excl. 1 x E27, max. 40 W

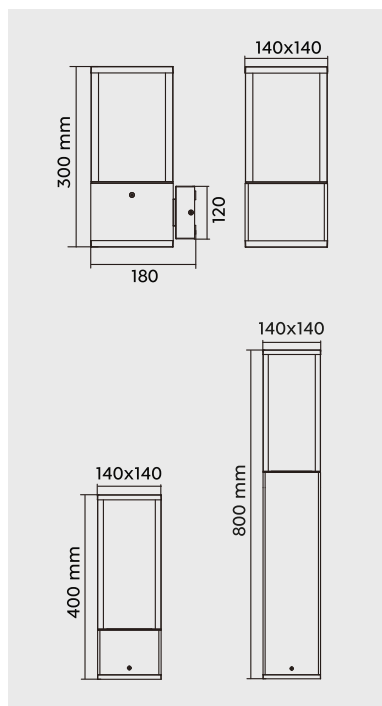

201860130



501860130



401860130

Empfohlen:
recommended:

Filament LED
E27, 4 W
400 lm, 2.700 K



987-400





GARONNE

Aluminium Druckguss, Glas
diecast aluminium, glass
fonte d'aluminium, verre
gegoten aluminium, glas
aluminio fundido, vidrio
pressofusione di alluminio, vetro
fonta aluminii, sticla
valualumiini, lasi
barwione aluminium, szkło

42 Anthrazit · anthracite

Excl. 1 x E27, max. 40 W

201860142

401860142

501860142

Excl. 2 x E27, max. 40 W

201860242

601860242



IP44



601860242



201860142



201860242



401860142



501860142

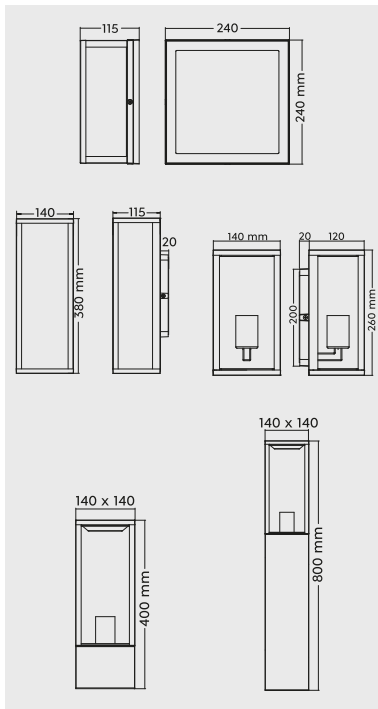

Empfohlen:
recommended:

Filament LED
E27, 6 W
600 lm, 3.000 K



987-600

Empfohlen:
recommended:

Filament LED
E27, 4 W
400 lm, 2.700 K



987-400





GARONNE

Aluminium Druckguss, Glas
 diecast aluminium, glass
 fonte d'aluminium, verre
 gegoten aluminium, glas
 aluminio fundido, vidrio
 pressofusione di alluminio, vetro
 fonta aluminiu, sticla
 valualumiini, lasi
 barwione aluminium, szkło

86 zinkfarbig · zinc-colored

Excl. 1 x E27, max. 40 W

201860186

401860186

501860186

Excl. 2 x E27, max. 40 W

201860286

601860286



IP44



601860286



201860186



201860286



401860186



501860186

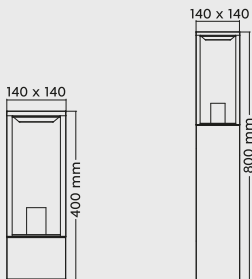
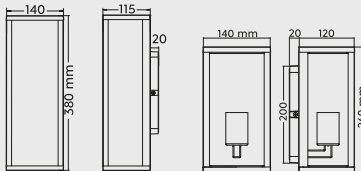
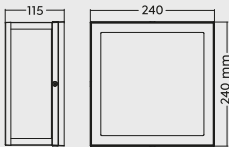

Empfohlen:
 recommended:

Filament LED
 E27, 6 W
 600 lm, 3.000 K



987-600

Empfohlen:
 recommended:

Filament LED
 E27, 4 W
 400 lm, 2.700 K



987-400



SAMBESI

Aluminium Druckguss, Acryl
diecast aluminium, acryl
fonte d'aluminium, acryl
gegoten aluminium, acryl
aluminio fundido, acrílico
pressofusione di alluminio, acrilico
fonta aluminiu, acrilic
valualumiini, akryyli
barwione aluminium, akryl

42 Anthrazit · anthracite

Excl. 1 x E27, max. 28 W



204160142



504160142

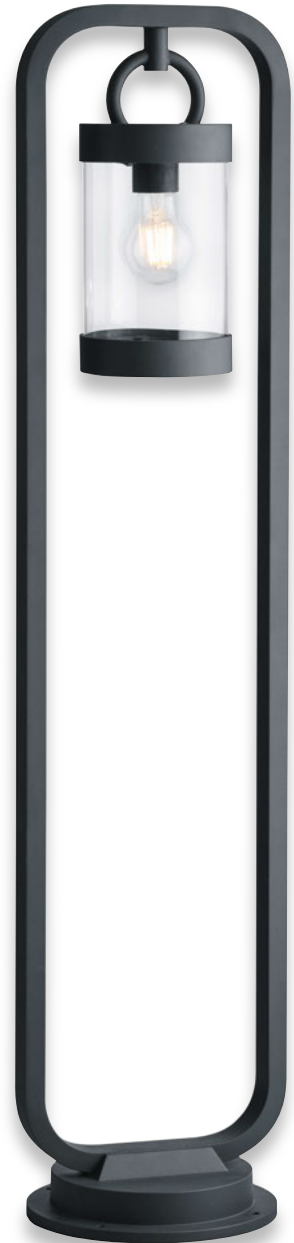

404160142

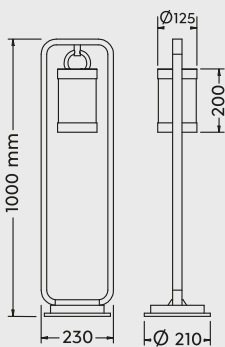
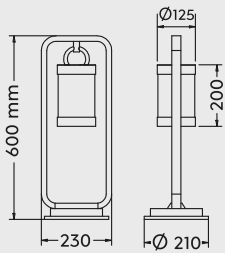
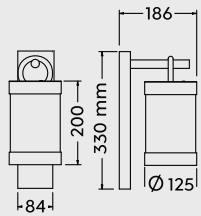

Empfohlen:
recommended:

Filament LED
E27, 4 W
400 lm, 3.000 K



987-400



Dämmerungssensor per Schalter deaktivierbar

On and off switchable dusk sensor

Détecteur de crépuscule commutable

Aan en uit schakelbare schemeringsensor

Sensor de oscuridad conmutable on/off

Sensore crepuscolare commutabile on/off

senzor de lumina/amurg on/off

On/off kytkettävä hämärätunnistin

Czujnik zmierzchowy dezaktywowany przez przełącznika

Aç-kapa anahtarlı karanlık sensörü

SAMBESI

Aluminium Druckguss, Acryl
diecast aluminium, acryl
fonte d'aluminium, acryl
gegoten aluminium, acryl
aluminio fundido, acrílico
pressofusione di alluminio, acrilico
fonta aluminiu, acrilic
valualumiini, akryyli
barwione aluminium, akryl

31 Weiß matt · white mat

Excl. 1 x E27, max. 28 W

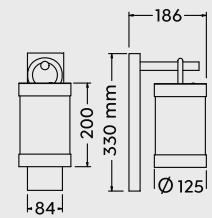

204160131

Empfohlen:
recommended:

Filament LED
E27, 4 W
400 lm, 3.000 K



987-400

SAMBESI

Aluminium Druckguss, Acryl
 diecast aluminium, acryl
 fonte d'aluminium, acryl
 gegoten aluminium, acryl
 aluminio fundido, acrílico
 pressofusione di alluminio, acrilico
 fonta aluminiu, acrilic
 valualumiini, akryyli
 barwione aluminium, akryl

24 rostfarbig · rusty

Excl. 1 x E27, max. 28 W



204160124



404160124



504160124

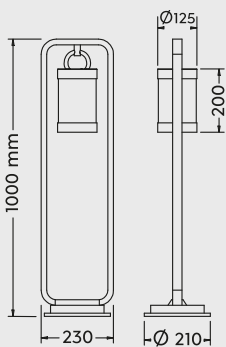
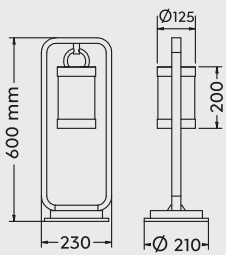
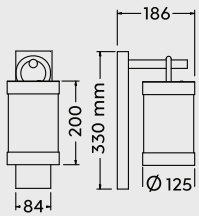

Empfohlen:
 recommended:

Filament LED
 E27, 4 W
 400 lm, 3.000 K



987-400

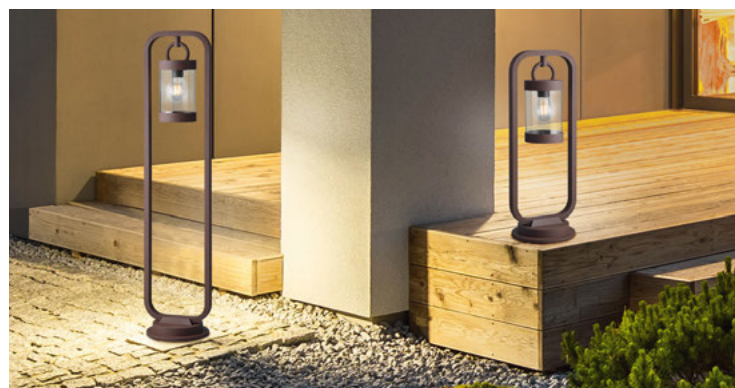



Dämmerungssensor per Schalter deaktivierbar

On and off switchable dusk sensor

Détecteur de crépuscule commutable

Aan en uit schakelbare schemeringsensor

Sensor de oscuridad conmutable on/off

Sensore crepuscolare commutabile on/off

senzor de lumina/amurg on/off

On/off kytkettävä hämärätunnistin

Czujnik zmierzchowy dezaktywowany przez przełącznika

Aç-kapa anahtarlı karanlık sensörü



SAMBESI

Aluminium Druckguss, Kunststoff
 diecast aluminium, plastic
 fonte d'aluminium, plastique
 gegoten aluminium, kunststof
 aluminio fundido, plástico
 pressofusione di alluminio, plastica
 fonta aluminiu, plastic
 valualumiini, muovi
 barwione aluminium, plastik

24 rostfarbig · rusty
31 Weiß matt · white mat
42 Anthrazit · anthracite

Excl. 1 x E27, max. 28 W

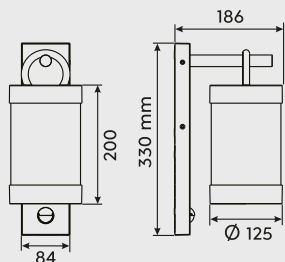

204169131



204169124

Empfohlen:
 recommended:

Filament LED
 E27, 4 W
 400 lm, 3.000 K



987-400

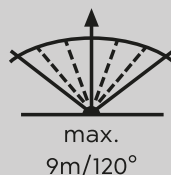

Bewegungssensor
 Motion sensor
 Détecteur de mouvement
 Bewegungssensor
 Sensor de movimiento
 Sensore di movimento
 Senzor de mișcare
 Liiketunnistin
 Czujnik ruchu



204169142

TANARO

Aluminium Druckguss, Acryl
diecast aluminium, acryl
fonte d'aluminium, acryl
gegoten aluminium, acryl
aluminio fundido, acrílico
pressofusione di alluminio, acrilico
fonta aluminiu, acrilic
valualumiini, akryyli
barwione aluminium, akryl

42 Anthrazit · anthracite

Excl. 1 x E27, max. 40 W

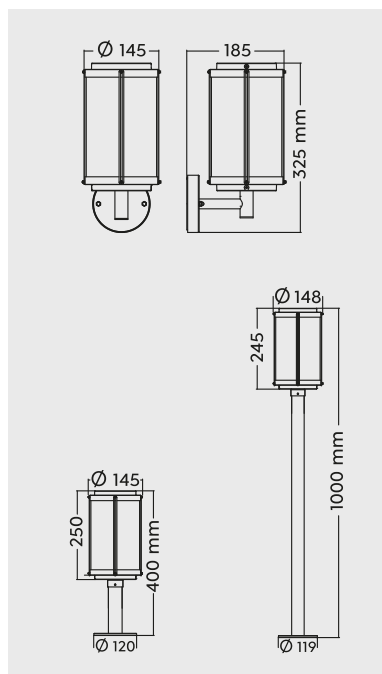

502360142



402360142

Empfohlen:
recommended:

Filament LED
E27, 4 W
400 lm, 3.000 K



987-400





202360142

TANARO

Aluminium Druckguss, Acryl
diecast aluminium, acryl
fonte d'aluminium, acryl
gegoten aluminium, acryl
aluminio fundido, acrílico
pressofusione di alluminio, acrilico
fonta aluminiu, acrilic
valualumiini, akryyli
barwione aluminium, akryl

24 rostfarbig · rusty

Excl. 1 x E27, max. 40 W



IP44

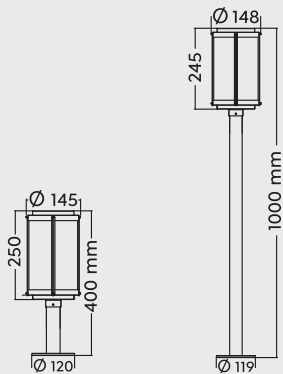
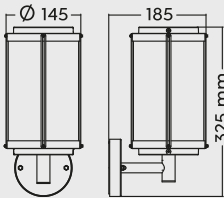

202360124



502360124



402360124

Empfohlen:
recommended:

Filament LED
E27, 4 W
400 lm, 3.000 K





BRENTA

Aluminium Druckguss, Glas
diecast aluminium, glass
fonte d'aluminium, verre
gegoten aluminium, glas
aluminio fundido, vidrio
pressofusione di alluminio, vetro
fonta aluminiu, sticla
valualumiini, lasi
barwione aluminium, szkło

24 rostfarbig · rusty

42 Anthrazit · anthracite

86 zinkfarbig · zinc-colored

Excl. 1 x E27, max. 40 W



IP44

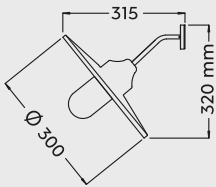

201760124



201760142



201760186

Empfohlen:
recommended:

Filament LED
E27, 4 W
400 lm, 3.000 K



987-400





BRENTA

Aluminium Druckguss, Glas
diecast aluminium, glass
fonte d'aluminium, verre
gegoten aluminium, glas
aluminio fundido, vidrio
pressofusione di alluminio, vetro
fonta aluminiu, sticla
valualumiini, lasi
barwione aluminium, szkło

24 rostfarbig · rusty

42 Anthrazit · anthracite

86 zinkfarbig · zinc-colored

Excl. 1 x E27, max. 40 W



IP44

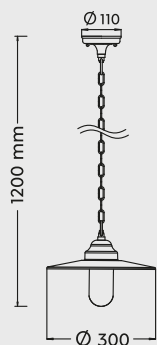

301760124



301760142



301760186

Empfohlen:
recommended:

Filament LED
E27, 4 W
400 lm, 3.000 K



987-400

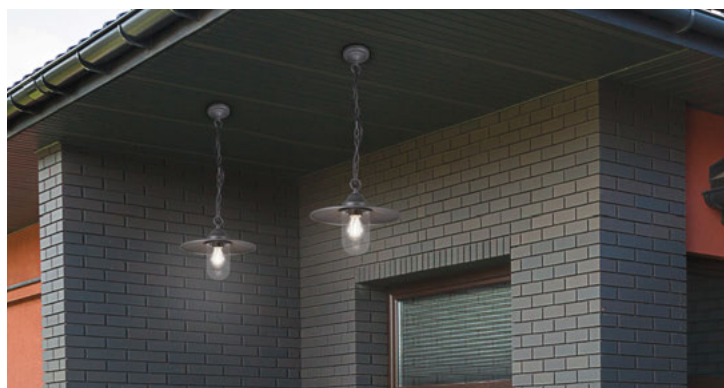



OLONA

Aluminium Druckguss, Glas
diecast aluminium, glass
fonte d'aluminium, verre
gegoten aluminium, glas
aluminio fundido, vidrio
pressofusione di alluminio, vetro
fonta aluminiu, sticla
valualumiini, lasi
barwione aluminium, szkło

24 rostfarbig · rusty

42 Anthrazit · anthracite

Excl. 1 x E27, max. 20 W



IP23

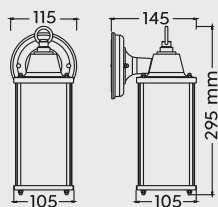

201960124



201960142

Empfohlen:
recommended:

Filament LED
E27, 4 W
400 lm, 3.000 K



987-400



ARKANSAS

Aluminium Druckguss, Glas
diecast aluminium, glass
fonte d'aluminium, verre
gegooten aluminium, glas
aluminio fundido, vidrio
pressofusione di alluminio, vetro
fonta aluminiu, sticla
valualumiini, lasi
barwione aluminium, szkło

24 rostfarbig · rusty

42 Anthrazit · anthracite

Excl. 1 x E27, max. 40 W



IP23

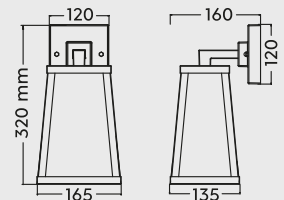

201360142

201360124

Empfohlen:
recommended:

Filament LED
E27, 4 W
400 lm, 3.000 K



987-400

GRACHT

Aluminium Druckguss, Acryl
diecast aluminium, acryl
fonte d'aluminium, acryl
gegoten aluminium, acryl
aluminio fundido, acrílico
pressofusione di alluminio, acrilico
fonta aluminiu, acrilic
valualumiini, akryyli
barwione aluminium, akryl

28 rostfarbig antik · antique rust

Incl. 1 x SMD-LED, 6 W
650 lm, 3.000 K

IP54

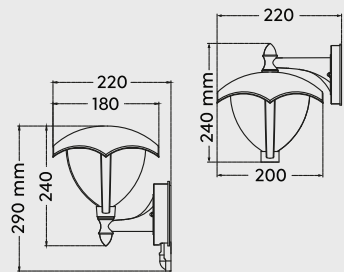

221967128



221969128

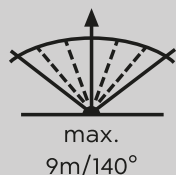

Bewegungssensor
Motion sensor
Détecteur de mouvement
Bewegingssensor
Sensor de movimiento
Sensore di movimento
Senzor de mişcare
Liiketunnistin
Czujnik ruchu



DUERO

Aluminium Druckguss, Glas
diecast aluminium, glass
fonte d'aluminium, verre
gegoten aluminium, glas
aluminio fundido, vidrio
pressofusione di alluminio, vetro
fonta aluminiu, sticla
valualumiini, lasi
barwione aluminium, szkło

24 rostfarbig · rusty

42 Anthrazit · anthracite

78 betonfarbig · concrete look

Excl. 1 x E27, max. 40 W



IP44

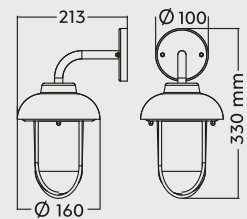

202760142

202760124

202760178

Empfohlen:
recommended:

Filament LED
E27, 4 W
400 lm, 3.000 K



987-400

KELLY

Aluminium Druckguss, Glas
diecast aluminium, glass
fonte d'aluminium, verre
gegoten aluminium, glas
aluminio fundido, vidrio
pressofusione di alluminio, vetro
fonta aluminiu, sticla
valualumiini, lasi
barwione aluminium, szkło

31 Weiß matt · white mat

42 Anthrazit · anthracite

Incl. 1 x SMD-LED, 9 W
900 lm, 3.000 K

IP44

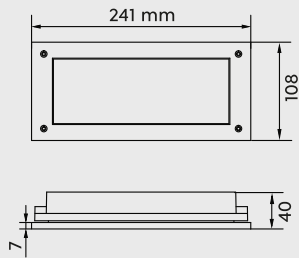

251060131



251060142



HARDEY

Aluminium Druckguss, Glas
diecast aluminium, glass
fonte d'aluminium, verre
gegoten aluminium, glas
aluminio fundido, vidrio
pressofusione di alluminio, vetro
fonta aluminiu, sticla
valualumiini, lasi
barwione aluminium, szkło

31 Weiß matt · white mat

42 Anthrazit · anthracite

Incl. 1 x SMD-LED, 9 W
900 lm, 3.000 K

IP44

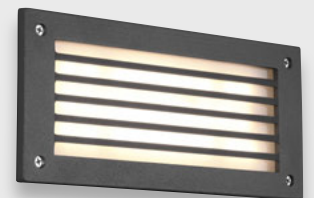
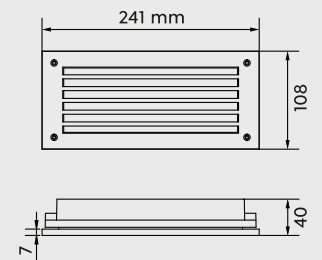

251160142



Bodeneinbaustrahler
 Recessed floor lamps
 Luminaires encastrés de sol
 grond inbouwspot
 Lámparas de pie empotradas
 Incasso Calpestabili
 Lampi incastrate in podea
 upotetut maavalot
 wpuszczone lampy podłogowe

07 Nickel matt · nickel mat

Incl. 1 x SMD-LED, 3 W
 180 lm, 3.000 K

IP65

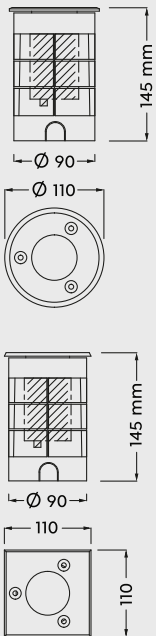

821660107



821669107



Abstrahlwinkel
 Emission angle
 Angle de rayonnement
 Uitstraalhoek
 Ángulo de emisión
 Angolo di emissione
 Unghiul de emisii
 Säteilukulma
 Kąt emisji



Belastbarkeit
 Resilience
 Limite de charge
 Belastbaarheid
 Resistencia
 Resistenza
 Rezistența la solicitare
 Kuormitettavuus
 Nośność



Bodeneinbaustrahler
 Recessed floor lamps
 Luminaires encastrés de sol
 grond inbouwspot
 Lámparas de pie empotradas
 Incasso Calpestabili
 Lampi incastrate in podea
 upotetut maavalot
 wpuszczone lampy podłogowe

07 Nickel matt · nickel mat

Incl. 1 x SMD-LED, 9 W
 540 lm, 3.000 K

IP65

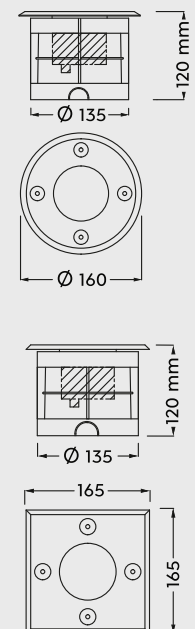

821660207



Abstrahlwinkel
 Emission angle
 Angle de rayonnement
 Uitstraalhoek
 Ángulo de emisión
 Angolo di emissione
 Unghiul de emisii
 Säteilykulma
 Kąt emisji



Belastbarkeit
 Resilience
 Limite de charge
 Belastbaarheid
 Resistencia
 Resistenza
 Rezistența la solicitare
 Kuormitettavuus
 Nośność



821669207

NECTOR

Kunststoff
 plastic
 plastique
 kunststof
 plástico
 plastica
 plastic
 muovi
 plastik

01 Weiß · white

Incl. RGBW-LED, 8,5 W
 600 lm, 3.000 - 5.500 K

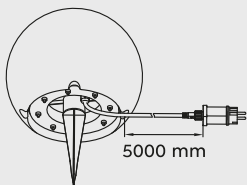
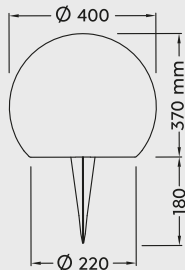
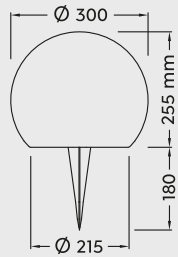

551753001



551754001



+



64.000 **WEISSTÖNE**
 64,000 **WHITES**



Voreingestellte Lichtmodi · Preset light modes



16 Millionen **FARBEN**
 16 million **COLORS**



Dynamische Lichtmodi · Dynamic light modes



WIZ
 CONNECTED

trio-lighting.com/wiz

Get your light connected.



WiZ
APP



Wlan Technologie
WiFi technology



WiZ
MOTE



WiZ
CLICK

UBANGI

Aluminium Druckguss
diecast aluminium
fonte d'aluminium
gegoten aluminium
aluminio fundido
pressofusione di alluminio
fonta aluminiu
valualumiini
barwione aluminium

42 Anthrazit · anthracite

Excl. 1 x GU10, max. 28 W



IP65



800260142

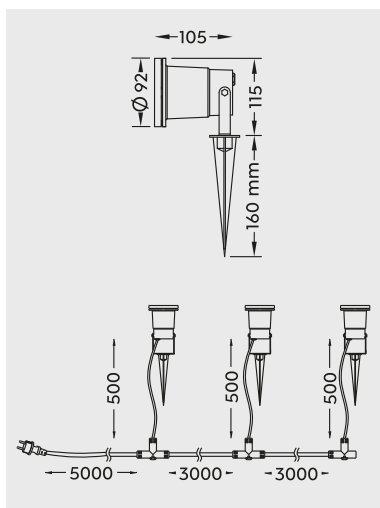

800260342
3er Set/3 pc.

Empfohlen:
recommended:

LED GU10, 5 W
400 lm, 3.000 K
≥ 120°



955-50





GARTENSTECKDOSEN · GARDEN SOCKETS

Polyresin
polyresin
polyresin
polyresin
poliresina
poliestere
polirasina
polyresiini
polyresin

11 Grau · grey

Zeitschaltuhr · timer
max. 3.600 W

9961-11



max. 3.600 W

9962-11

9963-11



9961-11



9962-11

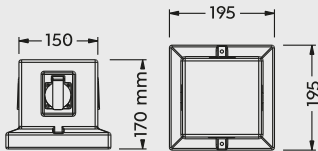
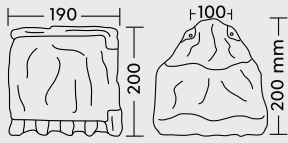

9963-11





9964-42

Aluminium Druckguss
diecast aluminium
fonte d'aluminium
gegooten aluminium
aluminio fundido
pressofusione di alluminio
fonta aluminiu
valualumiini
barwione aluminium

42 Anthrazit · anthracite

max. 3.600 W

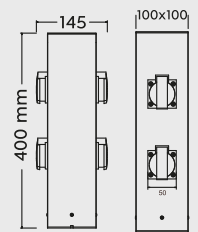

UNIVERSAL-ERDSPIESS · GROUND SPIKE

Erdspieß, Edelstahl
Ground spike, steel
Piquet de terre, acier
Aardingspin, staal
Espiga, acero
Picchetto, acciaio
Țepușă pentru pământ, inox
Maapiikki, teräs
Žerdz, stal

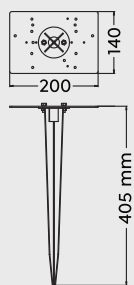

9960-07

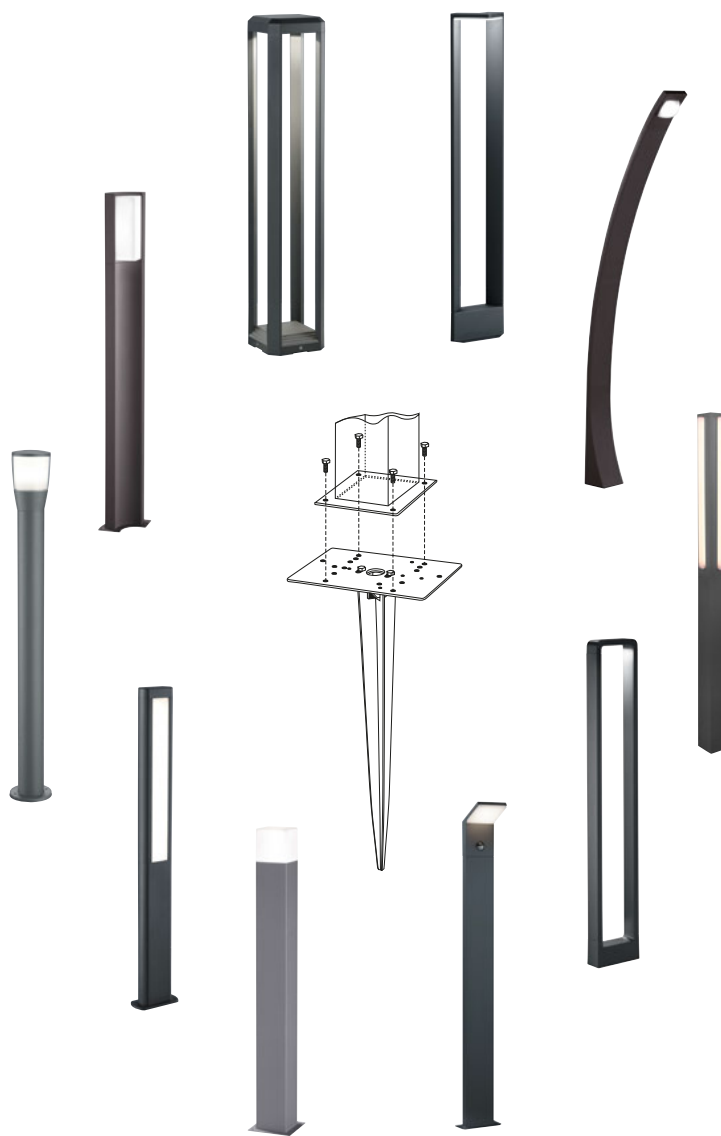

ECKBEFESTIGUNG · CORNER FASTENING

Eckbefestigung, Kunststoff
Corner fastening, plastic
Montage en angle, plastique
Hoekbevestiging, kunststof
Cantонера, plástico
Montaggio ad angolo, plastica
Fixare pentru colț, plastic
Kulmakiinnike, muovi
Okucie narożne, plastik

32 Schwarz matt · black mat

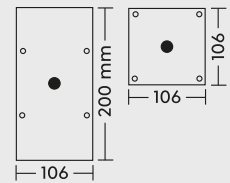
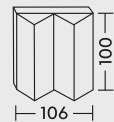

9965-32

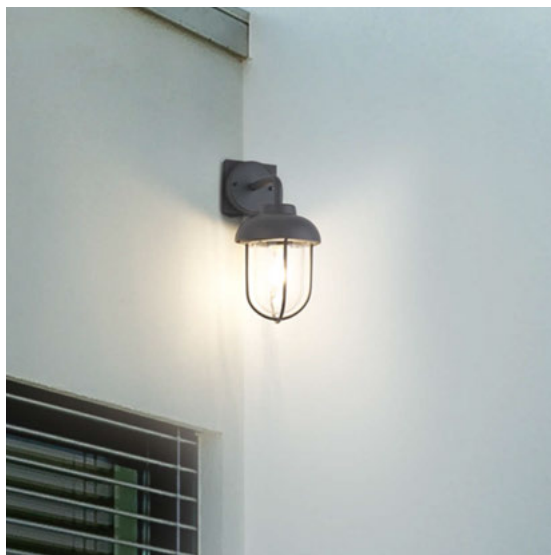
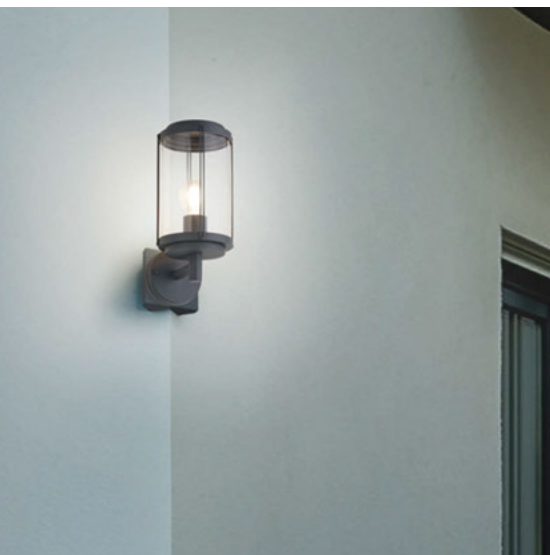





ARACATI

Nickel matt, Acryl
nickel mat, acryl
nickel mat, acryl
nikkel mat, acryl
níquel mate, acrílico
nichel opaco, acrilico
nichel mat, acrilic
harjattu teräs, akryyli
nikiel mat, akryl

07 Nickel matt · nickel mat

Incl. 1 x SMD-LED, 4 W
340 lm, 3.000 K

R28211107

IP44

Incl. 2 x SMD-LED, 4 W
2 x 340 lm, 3.000 K

R28212107

IP44

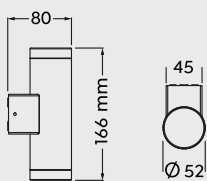
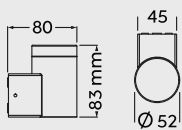

R28211107



R28212107





CORDOBA

Kunststoff
plastic
plastique
kunststof
plástico
plastica
plastic
muovi
plastik

31 Weiß matt · white mat

32 Schwarz matt · black mat

Incl. 2 x SMD-LED, 2 W
2 x 200 lm, 3.000 K



R28222631



R28222632

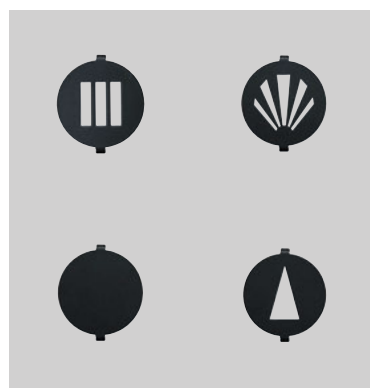
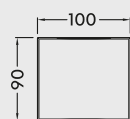
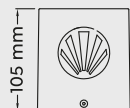

ROSARIO

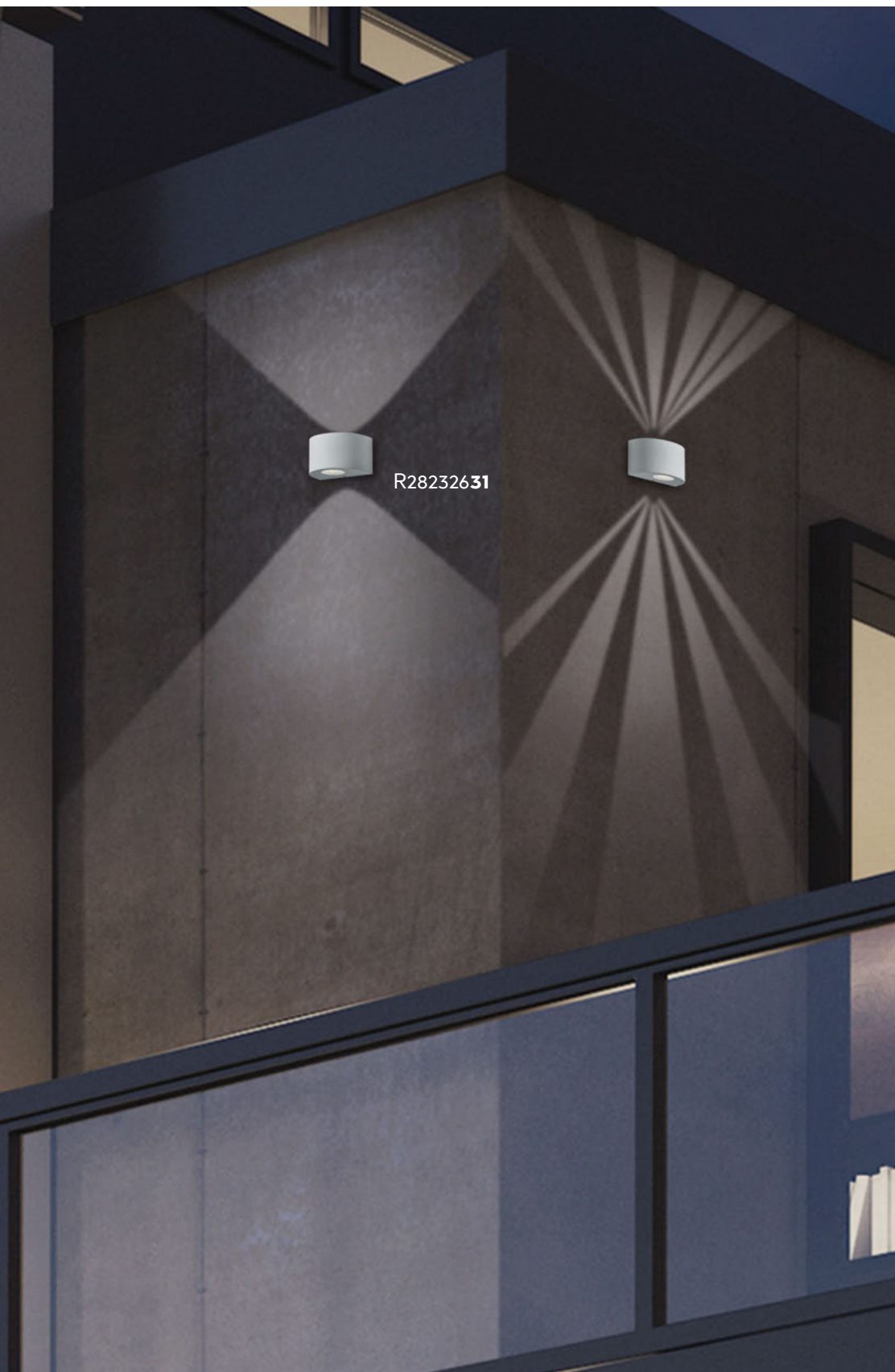

R28232631

Kunststoff
plastic
plastique
kunststof
plástico
plastica
plastic
muovi
plastik

31 Weiß matt · white mat

32 Schwarz matt · black mat

Incl. 2 x SMD-LED, 2 W
2 x 200 lm, 3.000 K

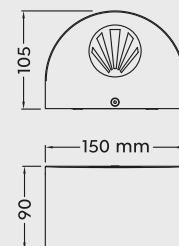

R28232632



BOGOTA

Aluminium Druckguss
diecast aluminium
fonte d'aluminium
gegoten aluminium
aluminio fundido
pressofusione di alluminio
fonta aluminii
valualumiini
barwione aluminium

42 Anthrazit · anthracite

Incl. 2 x SMD-LED, 3 W
2 x 260 lm, 3.000 K

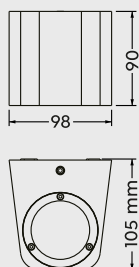

MOLINA

Aluminium Druckguss, Kunststoff
diecast aluminium, plastic
fonte d'aluminium, plastique
gegoten aluminium, kunststof
aluminio fundido, plástico
pressofusione di alluminio, plastica
fonta aluminiu, plastic
valualumiini, muovi
barwione aluminium, plastik

42 Anthrazit · anthracite

Incl. 2 x SMD-LED, 4,6 W
2 x 550 lm, 3.000 K

IP54

R22052142



R22062142

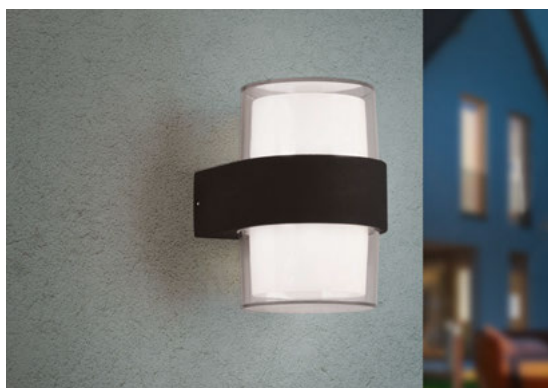
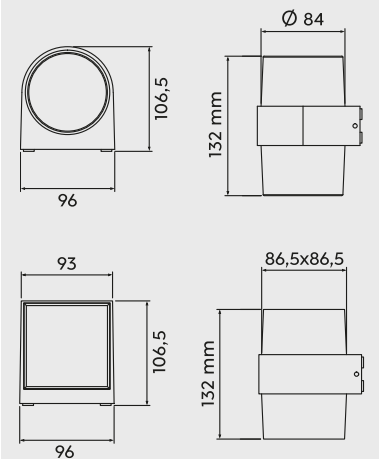

KENDAL

Kunststoff
 plastic
 plastique
 kunststof
 plástico
 plastica
 plastic
 muovi
 plastik

31 Weiß matt · white mat

42 Anthrazit · anthracite

Incl. SMD-LED, 12 W
 1.200 lm, 3.000 K

R22151131

R22151142

IP54

Incl. SMD-LED, 12 W
 1.000 lm, 3.000 K

R62151131

R62151142

IP54



R62151131



R62151142



R22151131



R22151142

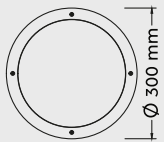



CAMARO

Kunststoff
 plastic
 plastique
 kunststof
 plástico
 plastica
 plastic
 muovi
 plastik

31 Weiß matt · white mat
42 Anthrazit · anthracite

Excl. 1 x E27, max. 12 W

R60501031
R60501042

Excl. 2 x E27, max. 12 W

R60502031
R60502042

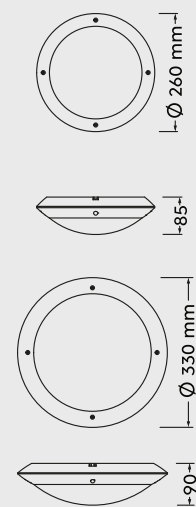

R60501031



R60501042



R60502031



R60502042

Empfohlen:
 recommended:

LED E27, 5 W
 400 lm, 3.000 K



986-60

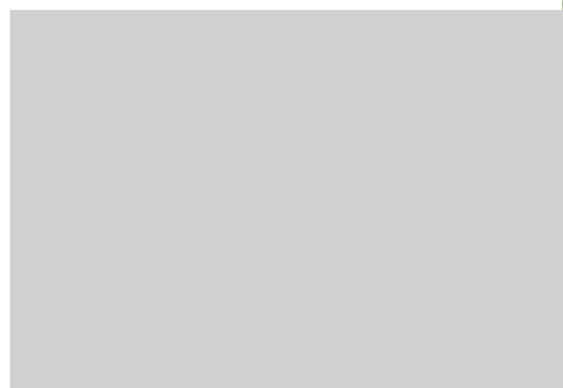





Außenbeleuchtung ist viel mehr als nur funktional!

Dank integriertem Akku sind die transportablen Leuchten flexibel und setzen spannende Akzente im Garten, auf dem Balkon oder der Terrasse - ganz ohne Kabel! Für die richtige Stimmung sorgen zusätzliche Highlights wie RGB-Farbwechsler oder Bluetooth-Funktion für kabelloses Musik hören. Die perfekte Beleuchtung für gemeinsame Abendstunden mit Familie und Freunden.

Outdoor lighting is much more than just functional!

Integrated rechargeable batteries lets you flexibly use these easily transportable lights to accent your garden, balcony or terrace in an exciting way, all without any cables! Additional highlights like an RGB colour wheels and Bluetooth for streaming music wirelessly provide just the right mood. The perfect lighting for spending evening hours with family and friends.

L'éclairage extérieur est bien plus que simplement fonctionnel !

Grâce à la batterie rechargeable intégrée, les lampes transportables sont flexibles et mettent des accents excitants dans le jardin, sur le balcon ou la terrasse –

sans aucun câble ! D'autres fonctions marquantes garantissent une bonne ambiance, telles que le changeur de couleurs RVB ou la fonction Bluetooth pour l'écoute de musique sans fil. L'éclairage parfait pour les soirées partagées avec la famille et les amis.

Buitenverlichting is veel meer dan enkel nuttig!

Dankzij de geïntegreerde accu zijn de verplaatsbare lampen flexibel en zorgen voor mooie accenten in de tuin, op het balkon of op het terras, en dat helemaal zonder kabel! Voor de juiste stemming zorgen extra hoogtepunten zoals de RGB-kleurenwisselaar of Bluetooth-functie om draadloos muziek te beluisteren. De perfecte verlichting om 's avonds aangenaam te vertoeven met vrienden en familie.

¡La iluminación exterior es mucho más que algo funcional!

Gracias a la batería integrada, las luces transportables son flexibles y aportan puntos de atención excitantes al jardín, al balcón o a la terraza - ¡y sin ningún tipo de cables! Se consigue el ambiente adecuado con otras características especiales adicionales como el modificador de color RGB o la función Bluetooth para escuchar música sin cables. La iluminación perfecta para pasar la tarde con la familia y los amigos.



L'illuminazione esterna è molto più che funzionale!

Grazie alla batteria ricaricabile integrata, le lampade portatili sono flessibili e creano accenti emozionanti in giardino, sul balcone o sulla terrazza - senza cavi! Ulteriori punti di forza come il cambiacolori RGB o la funzione Bluetooth per l'ascolto di musica senza fili assicurano il giusto feeling. L'illuminazione perfetta per le ore serali da trascorrere insieme alla famiglia e agli amici.

Iluminarea exterioară este mult mai mult decât funcțională!

Datorită acumulatorului integrat, lămpile transportabile sunt flexibile și oferă un aspect atrăgător în grădină, pe balcon sau pe terasă - fără cablu! Atmosfera potrivită este asigurată de jocurile suplimentare de lumină cum ar fi schimbarea culorilor RGB sau funcția Bluetooth pentru a asculta muzică fără cablu. Iluminarea perfectă pentru orele de seară cu familia și prietenii.

Ulkovalaistus on paljon muutakin kuin vain toimintaa!

Integroidun ladattavan akun ansiosta siirrettävät valaisimet ovat joustavia ja muodostavat jännittäviä korostuksia puutarhaan, parvekkeelle tai terassille - ilman kaapeleita! Lisäkorostukset, kuten RGB-väinvaihtajat tai Bluetooth-toiminto langattomaan musiikin kuuntelun, takaavat oikean ilmapiirin. Täydellinen valaistus illanviettoon yhdessä perheen ja ystävien kanssa.

Oświetlenie zewnętrzne to znacznie więcej niż tylko funkcjonalność!

Dzięki akumulatorowi przenośne lampy są elastyczne w ustawieniu i tworzą ekscytujące akcenty w ogrodzie, na balkonie lub tarasie - bez żadnych kabli! Odpowiedni nastrój zapewnią dodatkowe urządzenia, takie jak zmienne kolorów RGB lub funkcja Bluetooth do bezprzewodowego słuchania muzyki. Doskonałe oświetlenie wspólnych wieczorów z rodziną i przyjaciółmi.

PALMAS

Kunststoff
plastic
plastique
kunststof
plástico
plastica
plastic
muovi
plastik

01 Weiß · white

Incl. 1 x RGBW-LED, 1,5 W
45 lm, 3.000 K

R55101101

Incl. 1 x RGBW-LED, 3 W
90 lm, 3.000 K

R45101101

Incl. 1 x RGBW-LED, 4,5 W
120 lm, 3.000 K

R45101901

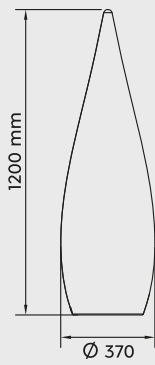
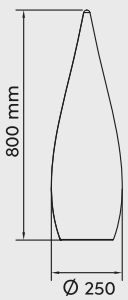

R55101101



R45101101



R45101901



RGBW Farbwechsler
RGBW Colorchanging
Changement de couleur RGBW
RGBW Kleurverandering
Cambio de color RGBW
Cambia colore RGBW
Schimbator de culoare RGBW
Värinvaihto RGB
Zmieniający kolor RGBW



Akkubetrieb
Rechargeable battery operated
Fonctionnement sur batteries rechargeable
Oplaadbare accu
Batería recargable
Batteria Ricaricabile
Operabil prin baterie reincarcabila
Ladattava akku
Akumulator zasilany bateryjnje
Şarj edilebilir pilli



Ladezeit
Charging time
Temps de charge
Oplaaftijd
Tiempo de carga
Tempo di carica
Timp de incarcare
Latausaika
Czas ładowania



Leuchtdauer
Luminous period
Durée d'éclairage
Brandtijd
Tiempo de iluminación
Tempo di durata
Perioada de iluminare
Valaistusaika
Czas świecenia

BERMUDA

Kunststoff
plastic
plastique
kunststof
plástico
plastica
plastic
muovi
plastik

01 Weiß · white

Incl. 1 x RGBW-LED, 1 W
35 lm, 3.000 K

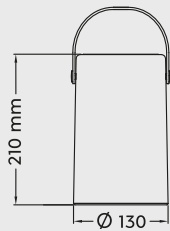

LIGHT & SOUND



R55060101



Bluetooth Lautsprecher
Bluetooth loudspeaker
Haut-parleur bluetooth
Bluetooth luidspreker
Altavoz de bluetooth
Altoparlante bluetooth
Difuzor Bluetooth
Bluetooth-kaiutin
Głośnik Bluetooth



Ladezeit
Charging time
Temps de charge
Oplaaadtijd
Tiempo de carga
Tempo di carica
Timp de incarcare
Latausaika
Czas ładowania



Leuchtdauer
Luminous period
Durée d'éclairage
Brandtijd
Tiempo de iluminación
Tempo di durata
Perioada de iluminare
Valaistusaika
Czas świecenia

JAMAICA

Kunststoff
plastic
plastique
kunststof
plástico
plastica
plastic
muovi
plastik

01 Weiß · white

Incl. 1 x RGBW-LED, 2,5 W
25 lm, 3.000 K

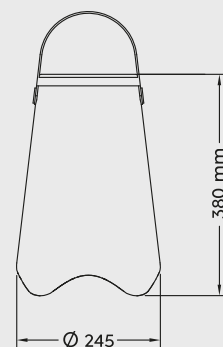

LIGHT & SOUND



R55086101

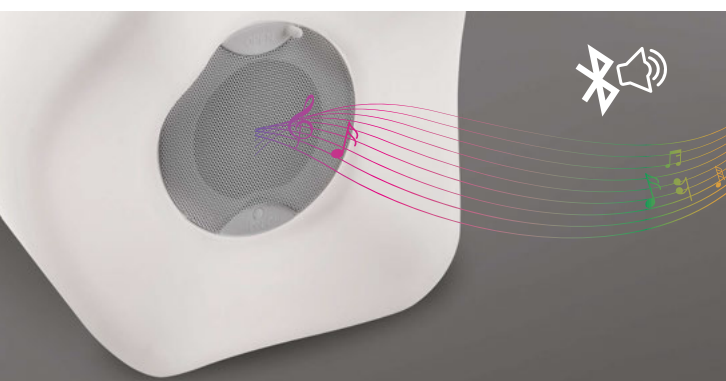

ARUBA

Kunststoff
plastic
plastique
kunststof
plástico
plastica
plastic
muovi
plastik

01 Weiß · white

Incl. 1 x RGBW-LED, 1 W
70 lm, 3.000 K

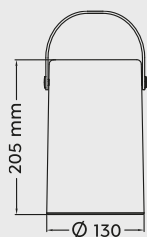

R57080101



RGBW Farbwechsler
RGBW Colorchanging
Changement de couleur RGBW
RGBW Kleurverandering
Cambio de color RGBW
Cambia colore RGBW
Schimbator de culoare RGBW
Värinvaihto RGB
Zmieniający kolor RGBW



USB Anschluss mit Ladefunktion
Recharging USB connection
Entrée USB de rechargement
Opladende USB aansluiting
Conexión USB de recarga
Connessione USB di ricarica
Conexiune USB reîncărcare
Lataaminen USB-liitäntä
Ładowania USB połączenie
șarj USB baġlantı

HAITI



R57090101

Kunststoff
plastic
plastique
kunststof
plástico
plastica
plastic
muovi
plastik

01 Weiß · white

Incl. 1 x RGBW-LED, 1 W
70 lm, 3.000 K

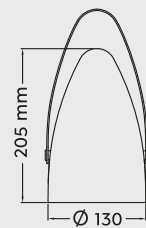

Ladezeit
Charging time
Temps de charge
Oplaadtijd
Tiempo de carga
Tempo di carica
Timp de incarcare
Latausaika
Czas ładowania



Leuchtdauer
Luminous period
Durée d'éclairage
Brandtijd
Tiempo de iluminación
Tempo di durata
Perioada de iluminare
Valaistusaika
Czas świecenia



HAWAII

Kunststoff
plastic
plastique
kunststof
plástico
plastica
plastic
muovi
plastik

01 Weiß · white

Incl. 1 x RGB-LED, 1,5 W
60 lm, 3.000 K

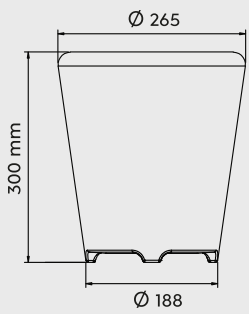
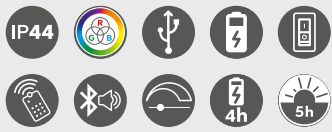

LIGHT & SOUND



R55096101



Bluetooth Lautsprecher
Bloutooth loudspeaker
Haut-parleur bluetooth
Bluetooth luidspreker
Altavoz de bluetooth
Altoparlante bluetooth
Difuzor Bluetooth
Bluetooth-kaiutin
Głośnik Bluetooth



Ladezeit
Charging time
Temps de charge
Oplaadtijd
Tiempo de carga
Tempo di carica
Timp de încarcare
Latausaika
Czas ładowania



Leuchtdauer
Luminous period
Durée d'éclairage
Brandtijd
Tiempo de iluminación
Tempo di durata
Perioada de iluminare
Valaistusaika
Czas świecenia

Kunststoff
plastic
plastique
kunststof
plástico
plastica
plastic
muovi
plastik

01 Weiß · white

Incl. 1 x SMD-LED, 1,5 W
130 lm, 3.000 K

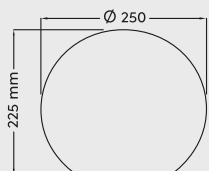
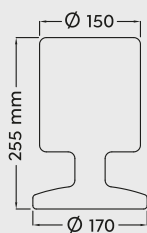

BARBADOS

R57010101



BAHAMAS

R57020101



Ladezeit
Charging time
Temps de charge
Oplaaadtijd
Tiempo de carga
Tempo di carica
Timp de incarcare
Latausaika
Czas ładowania



Leuchtdauer
Luminous period
Durée d'éclairage
Brandtijd
Tiempo de iluminación
Tempo di durata
Perioada de iluminare
Valaistusaika
Czas świecenia



DORA
R57051101

LORA
R57071101

Kunststoff
plastic
plastique
kunststof
plástico
plastica
plastic
muovi
plastik

01 Weiß · white

Incl. 1 x SMD-LED, 1,5 W
90 lm, 3.000 K

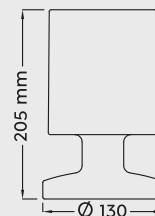
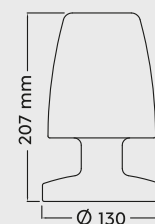

Akkubetrieb
Rechargeable battery operated
Fonctionnement sur batteries rechargeable
Oplaadbare accu
Batería recargable
Batteria Ricaricabile
Operabil prin baterie reincarcabila
Ladattava akku
Akumulator zasilany bateryjnie



USB Anschluss mit Ladefunktion
Recharging USB connection
Entrée USB de rechargement
Opladende USB aansluiting
Conexión USB de recarga
Connessione USB di ricarica
Conexiune USB reîncărcare
Lataaminen USB-liitäntä
Ładowania USB połączenie

DOMINGO

Metall, Kunststoff
 metal, plastic
 metale, plastique
 metaal, kunststof
 metal, plástico
 metallo, plastica
 metal, plastic
 metalli, muovi
 metal, plastik

42 Anthrazit · anthracite

Incl. 1 x SMD-LED, 2 W
 150 lm, 3.000 K

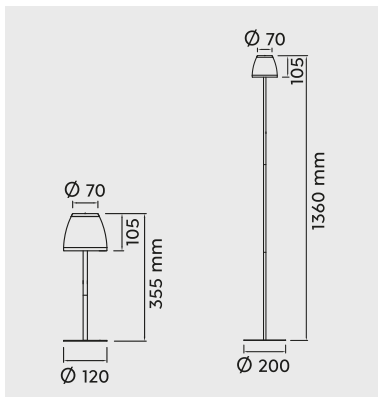

R52096142



R42096142

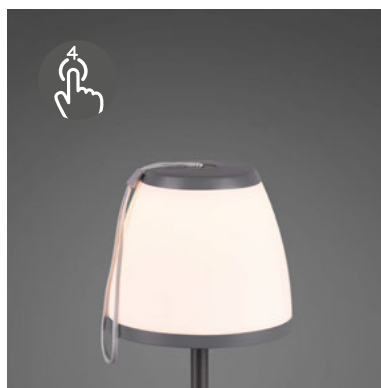

Ladezeit
 Charging time
 Temps de charge
 Oplaadtijd
 Tiempo de carga
 Tempo di carica
 Timp de încarcare
 Latausaika
 Czas ładowania



Leuchtdauer
 Luminous period
 Durée d'éclairage
 Brandtijd
 Tiempo de iluminación
 Tempo di durata
 Perioada de iluminare
 Valaistusaika
 Czas świecenia

LENNON



R52176101

Kunststoff
plastic
plastique
kunststof
plástico
plastica
plastic
muovi
plastik

01 Weiß · white
02 Schwarz · black

Incl. 1 x SMD-LED, 2 W
200 lm, 3.000 K

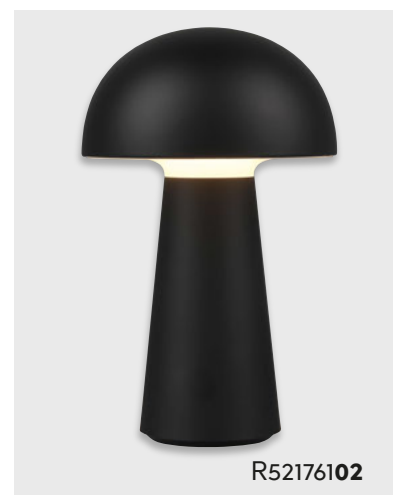
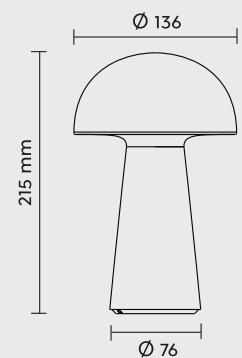

R52176102



Akkubetrieb
Rechargeable battery operated
Fonctionnement sur batteries rechargeable
Oplaadbare accu
Batería recargable
Batteria Ricaricabile
Operabil prin baterie reincarcabila
Ladattava akku
Akumulator zasilany baterijnie



USB Anschluss mit Ladefunktion
Recharging USB connection
Entrée USB de rechargement
Opladende USB aansluiting
Conexión USB de recarga
Connessione USB di ricarica
Conexiune USB reîncărcare
Lataaminen USB-liitäntä
Ładowania USB połączenie



BOLO

Kunststoff
plastic
plastique
kunststof
plástico
plastica
plastic
muovi
plastik

01 Weiß · white

Excl. 1 x E27, max. 23 W

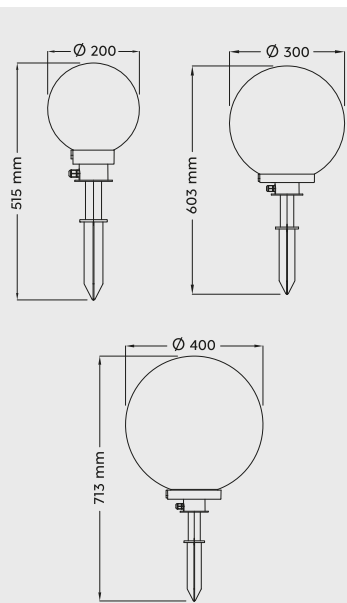

R57043001



R57042001



R57044001

Empfohlen:
recommended:

LED E27, 10 W
806 lm, 3.000 K



R988-90







Sonne Tanken!

Solarleuchten nutzen ausschließlich die Kraft der Sonne um Licht zu erzeugen. Dabei sind sie extrem umwelt-schonend, sparsam und gleichermaßen praktisch, da sie weder Steckdosen noch einen Anschluss ans Stromnetz benötigen. In Kombination mit moderner LED-Technik bieten Solarleuchten ideales Licht für Haus und Garten.

Soak up the sun!

Solar lamps exclusively use the power of the sun to generate light. At the same time they are extremely environmentally friendly and economical as well as practical, as they need neither sockets nor a connection to the mains supply. In combination with modern LED technology, solar lamps provide an ideal light for home and garden.

Faites le plein de soleil !

Les lampes solaires utilisent exclusivement l'énergie du soleil pour générer de la lumière. En même temps, elles sont extrêmement écologiques, économiques et tout aussi pratiques, car elles ne nécessitent ni prise de courant ni raccordement au réseau électrique. En combinaison avec la technologie LED moderne, les lampes solaires fournissent une lumière idéale pour la maison et le jardin.

Doe zon op!

Zonnelampen maken uitsluitend gebruik van de kracht van de zon om licht te produceren. Daarbij zijn ze extreem milieuvriendelijk, zuinig en in gelijke mate praktisch, omdat ze noch een stopcontact noch een aansluiting op het stroomnet nodig hebben. In combinatie met moderne ledtechniek bieden z onnelampen ideaal licht voor huis en tuin.

¡Disfrute del sol!

Las luces solares usan exclusivamente la energía del sol para generar luz. Al mismo tiempo, son extremadamente ecológicas, económicas e igualmente prácticas, y no necesitan ni enchufes ni conexión a la corriente. En combinación con las modernas técnicas LED, las luces solares ofrecen una luz ideal para la casa y el jardín.



Prendete un po' di sole!

Le lampade solari utilizzano esclusivamente la potenza del sole per generare luce. Allo stesso tempo sono estremamente rispettose dell'ambiente, economiche e pratiche in quanto non richiedono né presa di corrente, né un collegamento alla rete elettrica. In combinazione con la moderna tecnologia LED, le lampade solari forniscono una luce ideale per la casa e il giardino.

Alimentați cu soare!

Lămpile solare se folosesc în exclusivitate de energia soarelui pentru a genera lumină. În acest context sunt extrem de ecologice, economice și practice în același timp, deoarece nu necesită nici prize și nici conectarea la o rețea electrică. În combinație cu tehnologia modernă LED, lămpile solare oferă lumina ideală pentru casă și grădină.

Ajattele aurinkoa!

Aurinkovalaisimet käyttävät auringon energiaa valon tuottamiseen. Samalla ne ovat erittäin ympäristöystävällisiä, taloudellisia ja myös käytännöllisiä, koska ne eivät vaadi pistorasioita tai liitäntää sähköverkkoon. Yhdessä modernin LED-tekniikan kanssa aurinkovalaisimet tarjoavat ihanteellisen valaistuksen kotiin ja puutarhaan.

Nałapać energii słonecznej!

Lampy solarne wykorzystują moc słońca do generowania światła. Są one przy tym niezwykle przyjazne dla środowiska, ekonomiczne i jednocześnie praktyczne, ponieważ nie wymagają gniazd ani podłączenia do sieci elektrycznej. W połączeniu z nowoczesną technologią LED lampy solarne zapewniają idealne oświetlenie domu i ogrodu.

POSADAS

Kunststoff
 plastic
 plastique
 kunststof
 plástico
 plastica
 plastic
 muovi
 plastik

42 Anthrazit · anthracite

Incl. 1 x SMD-LED, 4,5 W
 290 lm, 3.000 K



R22251142

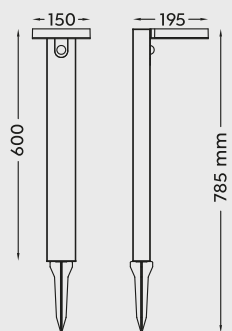
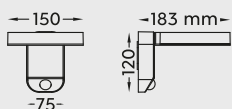

R42251142

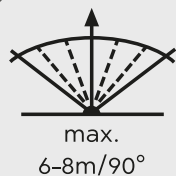

Ladezeit
 Charging time
 Temps de charge
 Oplaadtijd
 Tiempo de carga
 Tempo di carica
 Timp de incarcare
 Latausaika
 Czas ładowania



Leuchtdauer
 Luminous period
 Durée d'éclairage
 Brandtijd
 Tiempo de iluminación
 Tempo di durata
 Perioada de iluminare
 Valaistusaika
 Czas świecenia

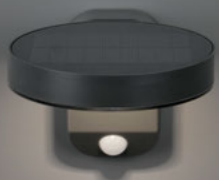



ESQUEL

Kunststoff
 plastic
 plastique
 kunststof
 plástico
 plastica
 plastic
 muovi
 plastik

42 Anthrazit · anthracite

Incl. 1 x SMD-LED, 4,5 W
 290 lm, 3.000 K

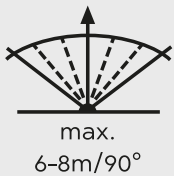
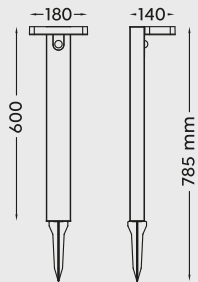
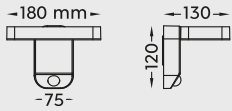

R22261142



R42261142



Ladezeit
 Charging time
 Temps de charge
 Oplaadtijd
 Tiempo de carga
 Tempo di carica
 Timp de încarcare
 Latausaika
 Czas ładowania



Leuchtdauer
 Luminous period
 Durée d'éclairage
 Brandtijd
 Tiempo de iluminación
 Tempo di durata
 Perioada de iluminare
 Valaistus aika
 Czas świecenia



Kunststoff
 plastic
 plastique
 kunststof
 plástico
 plastica
 plastic
 muovi
 plastik

42 Anthrazit · anthracite

Incl. 1 x SMD-LED, 5 W
 200 lm, 3.000 K

R22241142



Incl. 1 x SMD-LED, 4,8 W
 340 lm, 3.000 K

R22281142

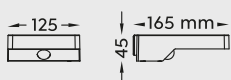

MENDOZA

R22241142



FOMOSA

R22281142



max.
 5-8m/90°



Ladezeit
 Charging time
 Temps de charge
 Oplaadtijd
 Tiempo de carga
 Tempo di carica
 Timp de încarcare
 Latausaika
 Czas ładowania

SALTA

Metall, Acryl
metal, acryl
metale, acryl
metaal, acryl
metal, acrílico
metallo, acrilico
metal, acrilic
metalli, akryyli
metal, akryl

07 Nickel matt · nickel mat

42 Anthrazit · anthracite

Incl. 1 x SMD-LED, 3 W
165 lm, 3.000 K



R22231107

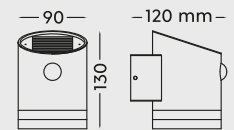

R22231142



Leuchtdauer
Luminous period
Durée d'éclairage
Brandtijd
Tiempo de iluminación
Tempo di durata
Perioada de iluminare
Valaistusaika
Czas świecenia

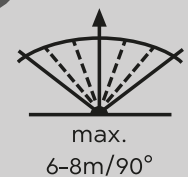

MINEROS

Kunststoff
plastic
plastique
kunststof
plástico
plastica
plastic
muovi
plastik

01 Weiß · white

11 Grau · grey

Incl. SMD-LED, 0,02 W



R55256101



R55256901

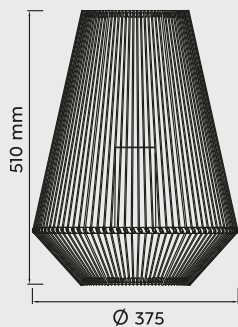
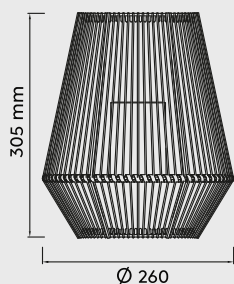

R55256911



R55256111



Ladezeit
Charging time
Temps de charge
Oplaadtijd
Tiempo de carga
Tempo di carica
Timp de incarcare
Latausaika
Czas ładowania



Leuchtdauer
Luminous period
Durée d'éclairage
Brandtijd
Tiempo de iluminación
Tempo di durata
Perioada de iluminare
Valaistus aika
Czas świecenia



Dämmerungssensor
Dusk sensor
Détecteur de crépuscule
Schemeringsensor
Sensor de oscuridad
Sensore crepuscolare
Sensor de lumina/amurg
Hämärätunnistin
Czujnik zmierzchowy



Flammen-Effekt
Flame effect
Effet de flamme
Vlammeneffect
Efecto de llamas
Effetto fiamma
Efect de flacăără
Liekkitehoste
Efekt płomienia

VINTO

Kunststoff
plastic
plastique
kunststof
plástico
plastica
plastic
muovi
plastik

44 Beige · fawn

Incl. SMD-LED, 0,1 W
R55276144



Incl. SMD-LED, 0,2 W
R55276944

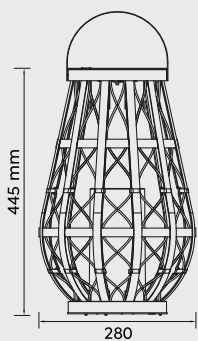
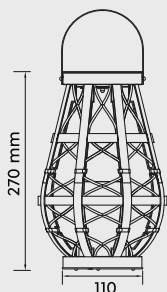

R55276144



R55276944



Ladezeit
Charging time
Temps de charge
Oplaadtijd
Tiempo de carga
Tempo di carica
Timp de incarcare
Latausaika
Czas ładowania



Leuchtdauer
Luminous period
Durée d'éclairage
Brandtijd
Tiempo de iluminación
Tempo di durata
Perioada de iluminare
Valaistusaika
Czas świecenia





MONTERO

Metall
metal
metale
metaal
metal
metallo
metal
metalli
metal

31 Weiß matt · white mat

88 Silber antik · antique silver

Incl. SMD-LED, 0,1 W

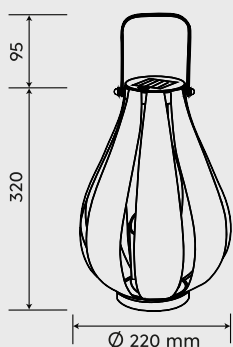

R55266131



R55266188

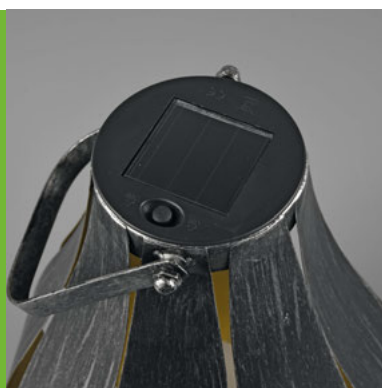

Ladezeit
Charging time
Temps de charge
Oplaaadtijd
Tiempo de carga
Tempo di carica
Timp de incarcare
Latausaika
Czas ładowania



Leuchtdauer
Luminous period
Durée d'éclairage
Brandtijd
Tiempo de iluminación
Tempo di durata
Perioada de iluminare
Valaistusaika
Czas świecenia

ARBIETO

Kunststoff
plastic
plastique
kunststof
plástico
plastica
plastic
muovi
plastik

42 Anthrazit · anthracite

Incl. SMD-LED, 0,02 W

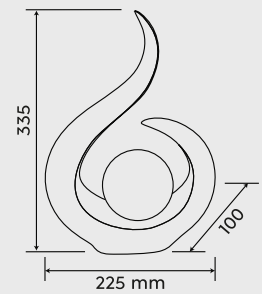

R55296142



Dämmerungssensor
Dusk sensor
Décteur de crépuscule
Schemeringsensor
Sensor de oscuridad
Sensore crepuscolare
Sensor de lumina/amurg
Hämärätunnistin
Czujnik zmierzchowy



Flammen-Effekt
Flame effect
Effet de flamme
Vlammeneffect
Efecto de llamas
Effetto fiamma
Efect de flacără
Liekkitehoste
Efekt płomienia



CAMIRI

Metall
metal
metale
metaal
metal
metallo
metal
metalli
metal

62 Kupfer antik · antique copper

88 Silber antik · antique silver

Incl. SMD-LED, 0,02 W

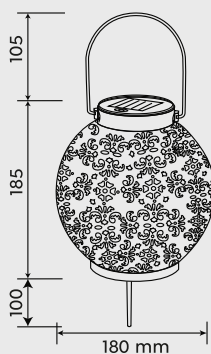

R55286188



R55286162



Ladezeit
Charging time
Temps de charge
Oplaadtijd
Tiempo de carga
Tempo di carica
Timp de incarcare
Latausaika
Czas ładowania



Leuchtdauer
Luminous period
Durée d'éclairage
Brandtijd
Tiempo de iluminación
Tempo di durata
Perioada de iluminare
Valaistusaika
Czas świecenia



Metall
metal
metale
metaal
metal
metallo
metal
metalli
metal

32 Schwarz matt · black mat

Incl. SMD-LED, 0,01 W

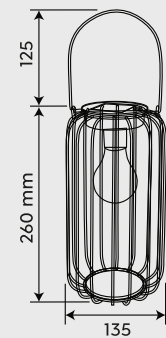

R55316132



Dämmerungssensor
Dusk sensor
Décteur de crépuscule
Schemeringsensor
Sensor de oscuridad
Sensore crepuscolare
Sensor de lumina/amurg
Hämärätunnistin
Czujnik zmierzchowy



Flammen-Effekt
Flame effect
Effet de flamme
Vlammeneffect
Efecto de llamas
Effetto fiamma
Efect de flacără
Liekkitehoste
Efekt płomienia



Kunststoff
 plastic
 plastique
 kunststof
 plástico
 plastica
 plastic
 muovi
 plastik

26 Braun · brown
32 Schwarz matt · black mat

Incl. SMD-LED, 0,1 W
R55196126



Incl. SMD-LED, 0,2 W
R55146132



CARMELO
 R55196126

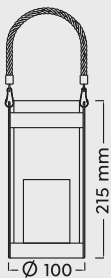

MINAS
 R55146132



Flammen-Effekt
 Flame effect
 Effet de flamme
 Vlammeneffect
 Efecto de llamas
 Effetto fiamma
 Efect de flacără
 Liekkitehoste
 Efect płomienia

Metall, Kunststoff
 metal, plastic
 metale, plastique
 metaal, kunststof
 metal, plástico
 metallo, plastica
 metal, plastic
 metalli, muovi
 metal, plastik

32 Schwarz matt · black mat

Incl. SMD-LED, 0,2 W

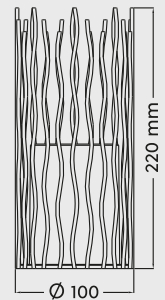

R55136132



Ladezeit
 Charging time
 Temps de charge
 Oplaadtijd
 Tiempo de carga
 Tempo di carica
 Timp de incarcare
 Latausaika
 Czas ładowania



Leuchtdauer
 Luminous period
 Durée d'éclairage
 Brandtijd
 Tiempo de iluminación
 Tempo di durata
 Perioada de iluminare
 Valaistusaika
 Czas świecenia

Kunststoff
plastic
plastique
kunststof
plástico
plastica
plastic
muovi
plastik

32 Schwarz matt · black mat

Incl. SMD-LED, 0,24 W



PARRAL

R55166132

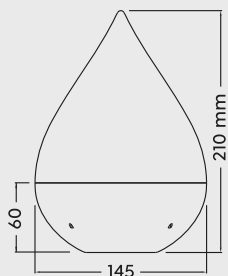
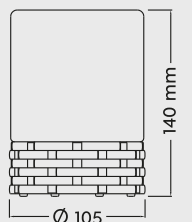

CALDERA

R55156132



Flammen-Effekt
Flame effect
Effet de flamme
Vlammeneffect
Efecto de llamas
Effetto fiamma
Efect de flacără
Liekkitehoste
Efekt plomienia





R55176132

Metall, Kunststoff
metal, plastic
metale, plastique
metaal, kunststof
metal, plástico
metallo, plastica
metal, plastic
metalli, muovi
metal, plastik

32 Schwarz matt · black mat

Incl. SMD-LED, 0,1 W

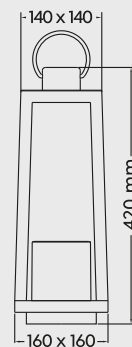

Ladezeit
Charging time
Temps de charge
Oplaadtijd
Tiempo de carga
Tempo di carica
Timp de incarcare
Latausaika
Czas ładowania



Leuchtdauer
Luminous period
Durée d'éclairage
Brandtijd
Tiempo de iluminación
Tempo di durata
Perioada de iluminare
Valaistusaika
Czas świecenia

MELO

Kunststoff
plastic
plastique
kunststof
plástico
plastica
plastic
muovi
plastik

01 Weiß · white

Incl. 1 x RGBW-LED, 0,5 W

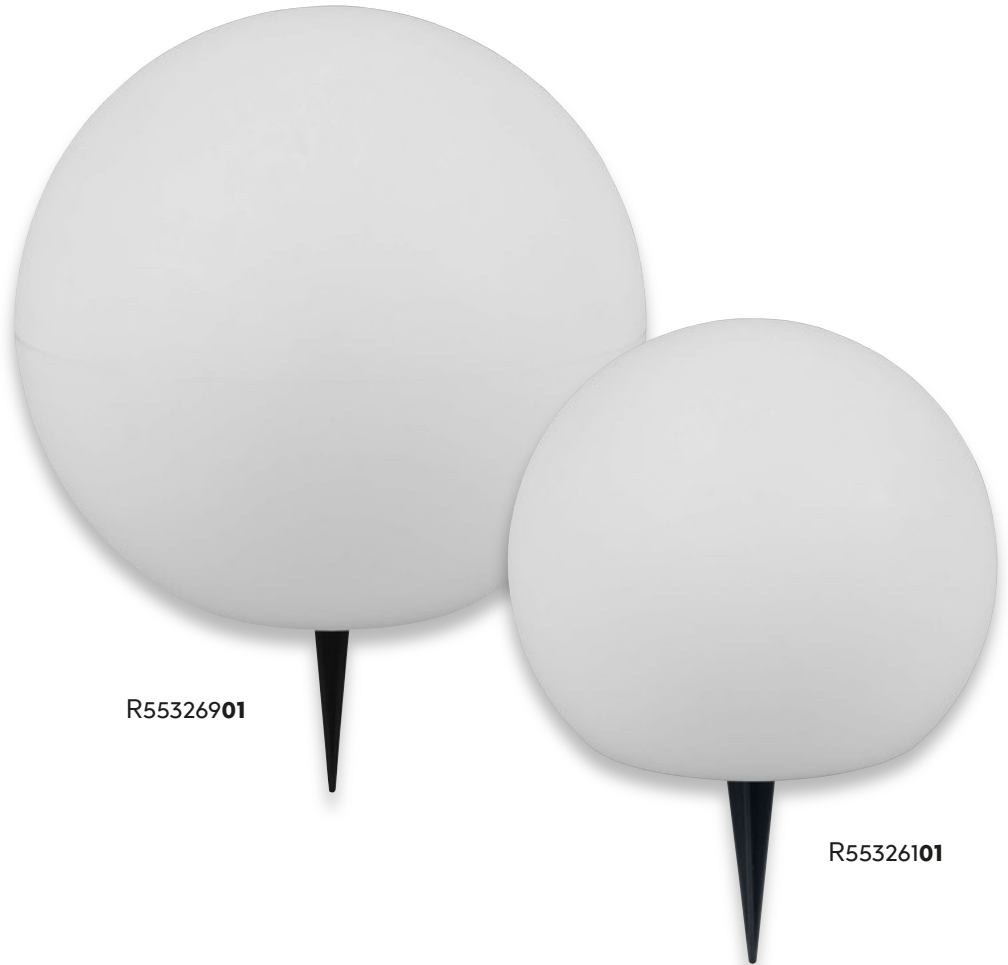
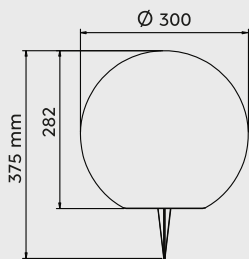
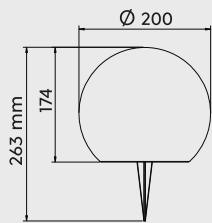
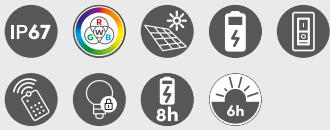

R55326901

R55326101



RGBW Farbwechsler
RGBW Colorchanging
Changement de couleur RGBW
RGBW Kleurverandering
Cambio de color RGBW
Cambia colore RGBW
Schimbator de culoare RGBW
Värvaihto RGB
Zmieniający kolor RGBW



Ladezeit
Charging time
Temps de charge
Oplaadtijd
Tiempo de carga
Tempo di carica
Timp de incarcare
Latausaika
Czas ładowania



Leuchtdauer
Luminous period
Durée d'éclairage
Brandtijd
Tiempo de iluminación
Tempo di durata
Perioada de iluminare
Valaistusaika
Czas świecenia