

COLLECTION

/2021

INDEX

Famiglia Daphine

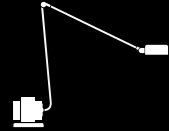

Daphine Led
027

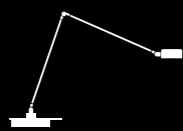

Daphine Cloe Led
033

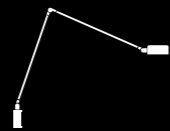

Daphine Cilindro Led
037

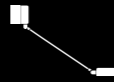

Daphine Parete Led
043

Famiglia Daphine

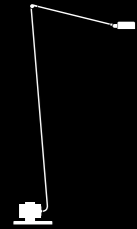

Daphine Terra Led
047



Daphinette Led
053



Daphinette Portatile
059

Famiglia Dot

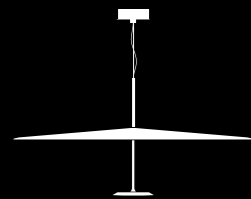

Dot
067

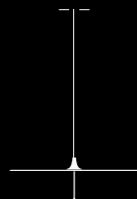

Dot Lite
077

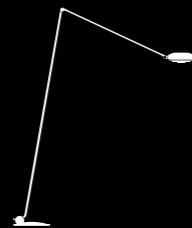

Elle Led
087

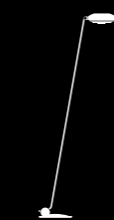

Elle 1 Led
087

Famiglia Elle

Famiglia EVA

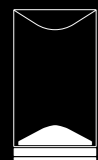

EVA
95

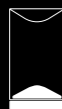

EVE
99



Flip
167

Famiglia Flo

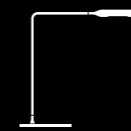

Flo Desk
107

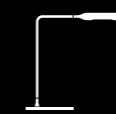

Flo Bedside
113

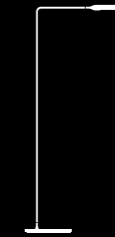

Flo Floor / Flo Lounge
117



Flo Wall / Flo Wall M
125

Famiglia Flo

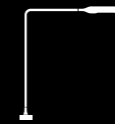

Flo Grommet
129

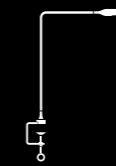

Flo Clamp
133

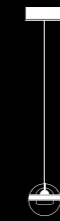

Limbus
139

Famiglia Limbus

Famiglia Matrix

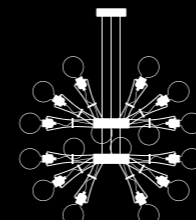

Matrix Doppia
175

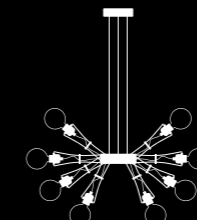

Matrix Otto
176

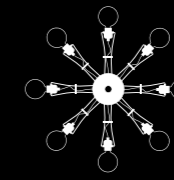

Matrix Otto P
179



Matrix Mono
180

Famiglia Moove

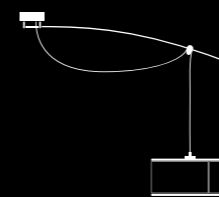

Moove
189



Moove Mono
189

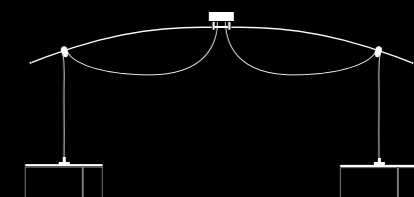

Moove Doppia
189

INDEX

Famiglia Naomi

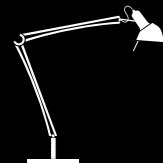

Naomi Tavolo
199

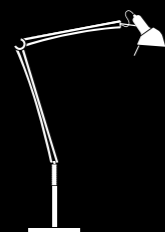

Naomi Terra
199



Naomi Parete
199



Naomi Pinza
199

Famiglia Naomi



Naomi Morsetto
201



Opus Terra
209



Opus Parete
209

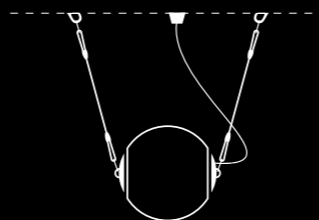

Perla 35 Garden
217

Famiglia Tangram

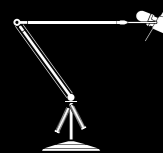

Tangram Tavolo
223

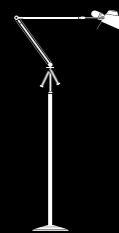

Tangram Terra
223

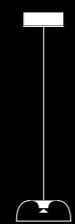

Tia 200
153

Famiglia Tia

INDEX

INTEGRATED LED

027	DAPHINE LED	95	EVA
033	DAPHINE CLOE LED	99	EVE
037	DAPHINE CILINDRO LED	107	FLO DESK
043	DAPHINE PARETE LED	113	FLO BEDSIDE
047	DAPHINE TERRA LED	117	FLO FLOOR / FLO LOUNGE
053	DAPHINETTE LED	125	FLO WALL / FLO WALL M
059	DAPHINETTE PORTATILE	129	FLO GROMMET
067	DOT	133	FLO CLAMP
077	DOT LITE	139	LIMBUS
087	ELLE LED	153	TIA 200
087	ELLE 1 LED		

LED BULBS

167	FLIP	199	NAOMI TERRA
175	MATRIX DOPPIA	199	NAOMI PARETE
176	MATRIX OTTO	199	NAOMI PINZA
179	MATRIX OTTO P	199	NAOMI MORSETTO
180	MATRIX MONO	209	OPUS TERRA
189	MOOVE	209	OPUS PARETE
189	MOOVE DOPPIA	217	PERLA 35 GARDEN
189	MOOVE MONO	223	TANGRAM TAVOLO
201	NAOMI TAVOLO	223	TANGRAM TERRA



DAPHINE LED

Undisputed emblem of elegance and functionality, the Daphine represents the essence of Lumina. The idea behind the creation of the Daphine lamp is as simple as it is effective: a pivoting diffuser, an articulated arm in two segments and an electromechanical transformer on a cylindrical base between two metal caps.

The Daphine first “saw the light” in a small workshop in Sedriano (Milan province) in 1975 thanks to the skilful hands of Tommaso Cimini, a mechanical engineering expert, and the machines he had retooled for the purpose.

The Daphine springs from Tommaso Cimini’s design philosophy, “Lots of light, not much lamp”, which is still the essence of every product bearing the name of Lumina, the company he set up in 1980. 45 years on, the Daphine’s aesthetic and functionality are unchanged, which goes to show the validity of the original idea.



Over the years it has figured in the collections of the world's main design and contemporary art museums, including the Brooklyn Museum and Judd Foundation in New York, the Musée des Arts Décoratifs in Paris, the Neue Sammlung in Munich and the Triennale in Milan.





TECHNICAL DETAILS

DAPHINE LED

Code: 01L



DIMENSIONS

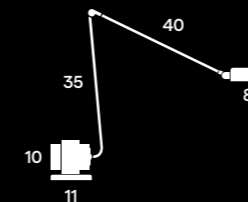

ACTIONS

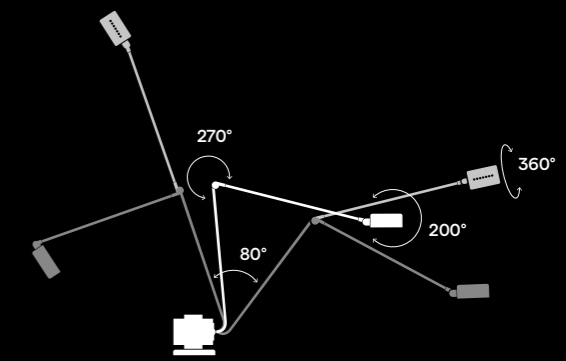

FINISHING

- | | | | |
|--|-------------------------|--|------------------------|
| | Black soft-touch | | Matt white |
| | Matt red | | Matt yellow |
| | Brushed nickel | | Metallic bronze |

LED SOURCE

Power:	9W	9W
CCT:	3000K	2700K
Emitted flux:	643 lm	622 lm
CRI:	97	97

Halogen version available on request

TECHNICAL DATA



High Colour Rendering Index
 Correlated Color Temperature 3000K or 2700K
 Energy Class A++
 Dimmer + 2 step switch
 Insulation Class III
 CE Listed
 ETL Listed



DAPHINE CLOE LED

The Daphine Cloe version is characterized by its flat base and was designed for ambiances in which the “technical” look of the original base would be excessive.

This flat base, which in the halogen version housed the toroidal transformer, now contains the electronics powering the LED and the articulated arm’s jack connection. The arm can be freely rotated and fully folded.





TECHNICAL DETAILS

DAPHINE CLOE LED

Code: 07L

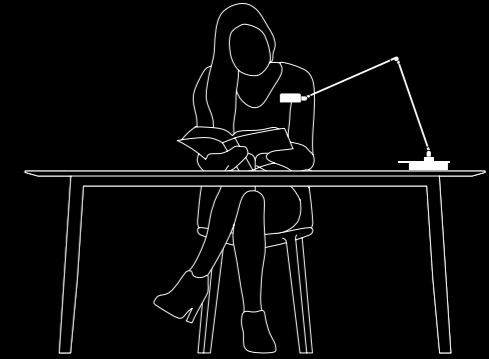

DIMENSIONS

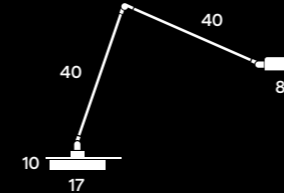

ACTIONS

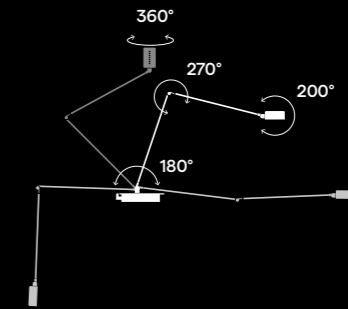

FINISHING

- | | | | |
|-----------------------|------------------|-----------------------|-----------------|
| <input type="radio"/> | Black soft-touch | <input type="radio"/> | Matt white |
| <input type="radio"/> | Matt red | <input type="radio"/> | Matt yellow |
| <input type="radio"/> | Brushed nickel | <input type="radio"/> | Metallic bronze |

LED SOURCE

Power:	9W	9W
CCT:	3000K	2700K
Emitted flux:	643 lm	622 lm
CRI:	97	97

TECHNICAL DATA

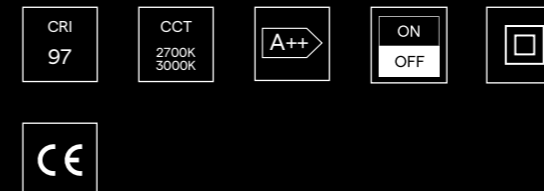

High Colour Rendering Index
 Correlated Color Temperature 3000K or 2700K
 Energy Class A++
 On/Off Switch
 Insulation Class II
 CE Listed



DAPHINE CILINDRO LED

Designed for workstations where optimization of space is crucial, the Daphine Cilindro has a much smaller base, to install on the work surface, while the articulated arm is longer to be able to ensure maximum flexibility.

As well as allowing full rotation, the arm's jack type connection makes it very simple to remove. The on/off switch is on the turned aluminium table attachment.





TECHNICAL DETAILS

DAPHNE CILINDRO LED

Code: 10L

DIMENSIONS

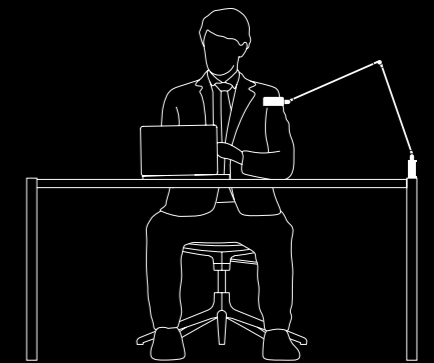
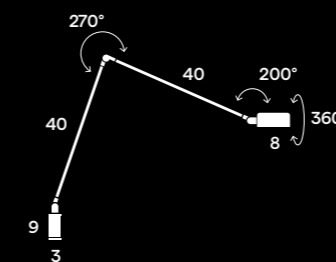

FINISHING

- | | | | |
|-----------------------|------------------|-----------------------|-----------------|
| <input type="radio"/> | Black soft-touch | <input type="radio"/> | Matt white |
| <input type="radio"/> | Matt red | <input type="radio"/> | Matt yellow |
| <input type="radio"/> | Brushed nickel | <input type="radio"/> | Metallic bronze |

LED SOURCE

Power:	9W	9W
CCT:	3000K	2700K
Emitted flux:	643 lm	622 lm
CRI:	97	97

TECHNICAL DATA

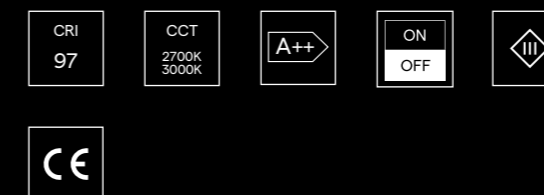

High Colour Rendering Index
 Correlated Color Temperature 3000K or 2700K
 Energy Class A++
 On/Off Switch
 Insulation Class III
 CE Listed



DAPHINE PARETE LED

The wall version, with its minimalist aesthetic, has a single arm that can be rotated through 180° horizontally and 90° vertically, till fully up against the wall.

Of the Daphine, it retains the unmistakable semi-cylindrical 8-hole diffuser (adjustable in any direction) and has a high colour quality LED source. The on/off switch is on the wall-mounted base.

Such features make the Daphine Parete ideal for use on bedside tables or by makeup or shaving mirrors. It's often used to light small pictures in corridors and anterooms.

Given its extreme robustness and high reliability, one of its main uses is in hotels.



TECHNICAL DETAILS

DAPHINE PARETE LED

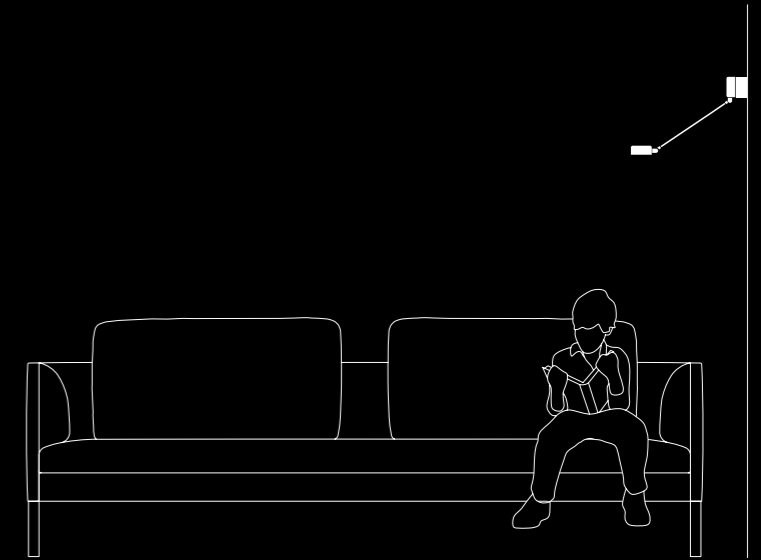

DIMENSIONS

Model: Parete 20

Code: 06L

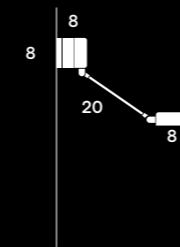

Model: Parete 35

Code: 05L

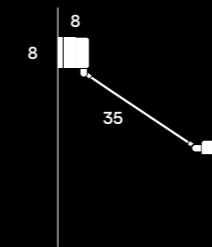

ACTIONS

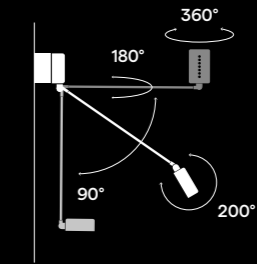

FINISHING

- | | | | |
|-----------------------|-------------------------|-----------------------|------------------------|
| <input type="radio"/> | Black soft-touch | <input type="radio"/> | Matt white |
| <input type="radio"/> | Matt red | <input type="radio"/> | Matt yellow |
| <input type="radio"/> | Brushed nickel | <input type="radio"/> | Metallic bronze |

LED SOURCE

Power:	5W	5W
CCT:	3000K	2700K
Emitted flux:	426 lm	410 lm
CRI:	97	97

TECHNICAL DATA

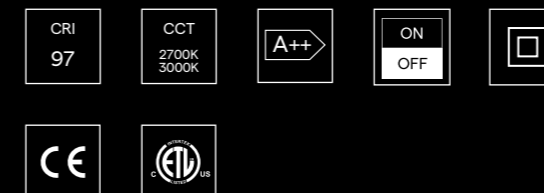

High Colour Rendering Index
 Correlated Color Temperature 3000K or 2700K
 Energy Class A++
 On/Off Switch
 Insulation Class II
 CE Listed
 ETL Listed



DAPHINE TERRA LED

A few years after the launch of the Daphine, a floor-standing version was introduced to extend its range of uses.

The Daphine Terra is still in great demand as a reading light to place by seating or bedside. Its 2-segment arm and freely adjustable head allow light to be trained where it's needed for maximum visual comfort. Both segments of the arm - of different, nicely proportioned lengths - can be set at various angles.

The Daphine Terra isn't only a reading lamp though: it's also ideal for ambient light, being powerful enough to deliver diffused lighting by pointing the beam at a wall. The bulkier cast iron base ensures perfect stability.

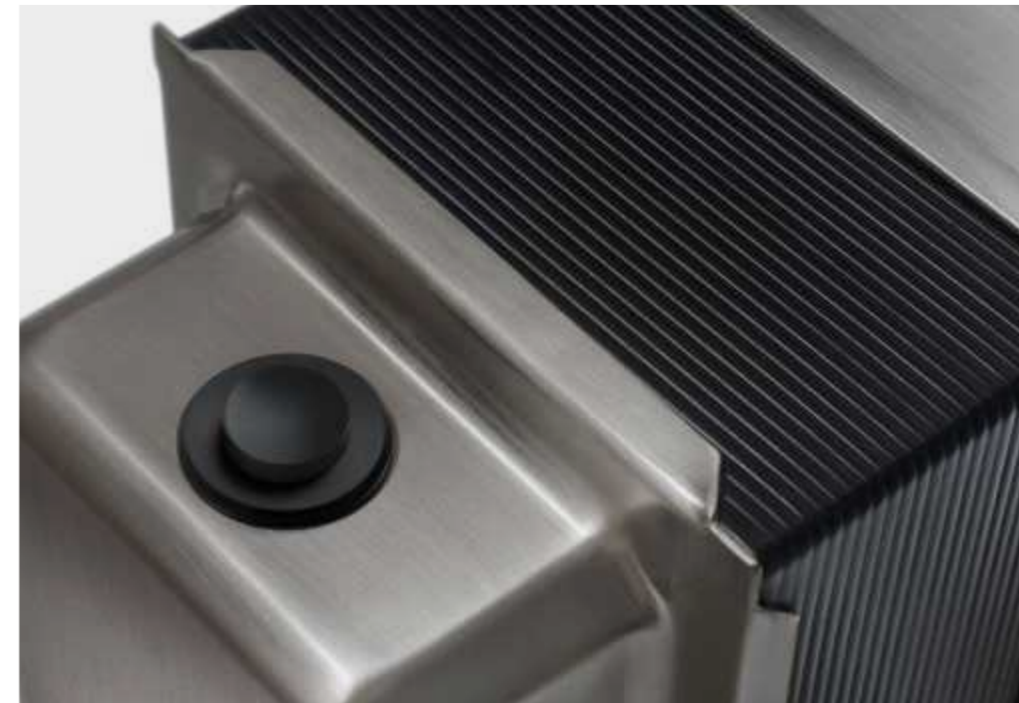





TECHNICAL DETAILS

DAPHINE TERRA LED

Code: 02L

DIMENSIONS

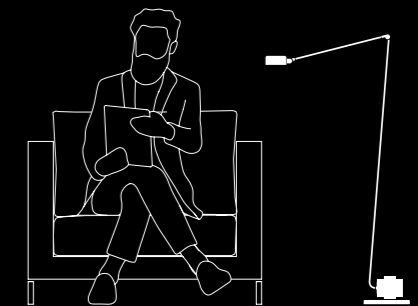
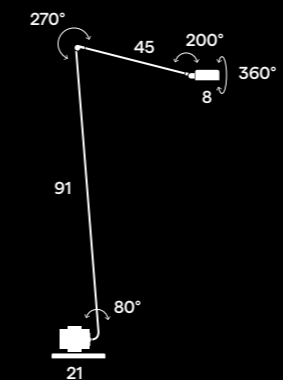

FINISHING

- | | | | |
|-----------------------|------------------|-----------------------|-----------------|
| <input type="radio"/> | Black soft-touch | <input type="radio"/> | Matt white |
| <input type="radio"/> | Matt red | <input type="radio"/> | Matt yellow |
| <input type="radio"/> | Brushed nickel | <input type="radio"/> | Metallic bronze |

LED SOURCE

Power:	9W	9W
CCT:	3000K	2700K
Emitted flux:	643 lm	622 lm
CRI:	97	97

TECHNICAL DATA



High Colour Rendering Index
 Correlated Color Temperature 3000K or 2700K
 Energy Class A++
 Dimmer + 2 step switch
 Insulation Class III
 CE Listed
 ETL Listed



DAPHINETTE LED

The Daphinette is a free-standing lamp designed for lighting and accenting small spaces.

Its reduced dimensions and well calibrated proportions make it highly versatile. With a single-segment arm and compact base, its ideal application is on desks, coffee tables or small shelves.

It's highly rated in the contract sector because of its minimalist aesthetic, strong personality and technical quality. It's used for spotlighting in hotel halls, libraries, conference rooms, banks and reception areas in general.



TECHNICAL DETAILS

DAPHINETTE LED

Code: 09L



DIMENSIONS

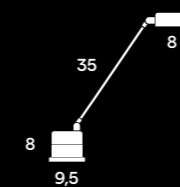

ACTIONS

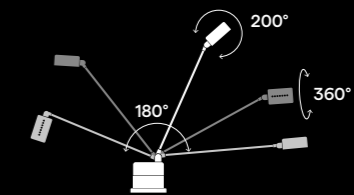

FINISHING

- | | | | |
|---|------------------|---|-----------------|
| ○ | Black soft-touch | ● | Matt white |
| ● | Matt red | ● | Matt yellow |
| ● | Brushed nickel | ● | Metallic bronze |

LED SOURCE

Power:	5W	5W
CCT:	3000K	2700K
Emitted flux:	426 lm	410 lm
CRI:	97	97

TECHNICAL DATA

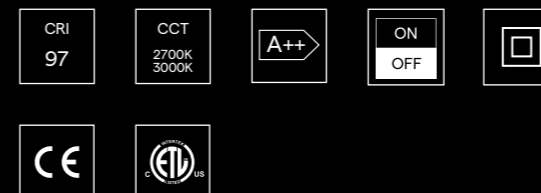

High Colour Rendering Index
 Correlated Color Temperature 3000K or 2700K
 Energy Class A++
 On/Off Switch
 Insulation Class II
 CE Listed
 ETL Listed

DAPHINETTE PORTATILE

/TOMMASO CIMINI





DAPHINETTE PORTATILE

The small version of Lumina's iconic Daphine lamp now comes in a rechargeable wireless version, the Daphinette Portatile.

It's a compact free-standing lamp that is highly versatile thanks to its key features:

- adjustable arm and diffuser enabling the light beam to be off-centred and directed;
- compact base ensuring stability and housing the rechargeable battery;
- advanced touch technology for lighting control fully dimmable.





Unique qualities that make the Daphinette Portatile ideal for both domestic spaces (eg. living room, studio, bedroom) and contract and retail spaces (eg. restaurants and stores) and anywhere else requiring a wireless lamp that's amply adjustable and with high luminous quality. And last but not least, aesthetically impeccable.

It has a battery providing an autonomy of up to 24 hours at minimum power and over 6 hours at maximum. The base also has touch controls for on/off and dimming and a USB-C port for recharging.



TECHNICAL DETAILS

DAPHINETTE PORTATILE

Code: 09P

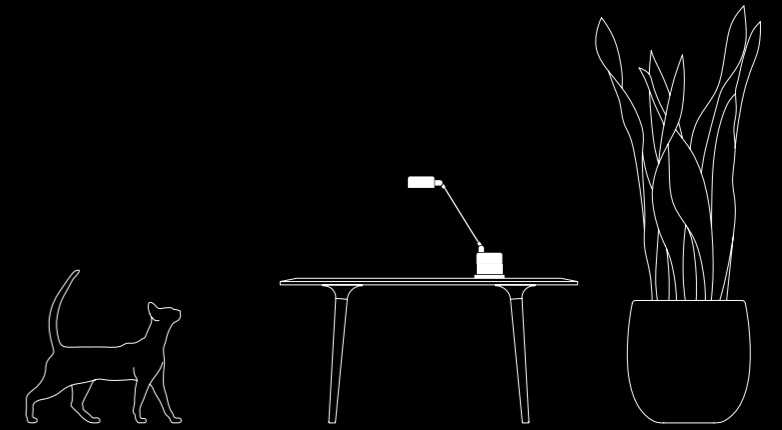

DIMENSIONS



FINISHING

- | | | | |
|-----------------------|-------------------------|-----------------------|------------------------|
| <input type="radio"/> | Black soft-touch | <input type="radio"/> | Matt white |
| <input type="radio"/> | Matt red | <input type="radio"/> | Matt yellow |
| <input type="radio"/> | Brushed nickel | <input type="radio"/> | Metallic bronze |

ACTIONS

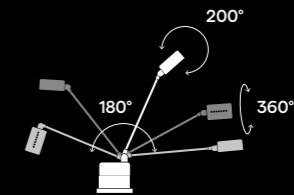

LED SOURCE

Power:	2,5W	2,5W
CCT:	3000K	2700K
Emitted flux:	194 lm	187 lm
CRI:	97	97

TECHNICAL DATA

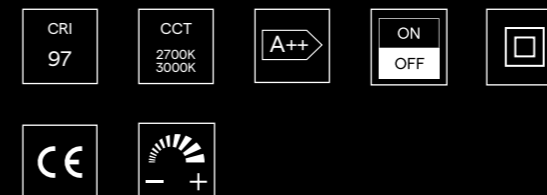

High Colour Rendering Index
 Correlated Color Temperature 3000K or 2700K
 Energy Class A++
 Dimmable touch sensor
 Insulation Class II
 CE Listed

DOT
/FOSTER+PARTNERS





DOT

Dot is a family of pendant lamps designed by Foster + Partners to make luminaires look like disks of light.

Their design neatly combines formal rigour and the most advanced lighting technology. Dot has two differently sized parallel disks connected through their centres by a thin metal tube. The bottom, smaller disk is turned aluminium and contains a LED ring optically engineered to cast a high quantity of light onto the top disk, the diffuser, made of lacquered aluminium.

The high-powered source generates an amount of heat that the bottom disk could not dissipate on its own. The problem was solved by placing a special heat sink used in the aerospace industry in the thin tube connecting the disks. Its function is to thermally connect the LED circuit to a heat dissipator housed in the top disk. On being switched on, the Dot is a thin, lightweight disk, seemingly suspended in mid-air, that generates an enveloping flux of light without shadows.





Dot comes in three different diameters and power ratings: ø60cm (23W), ø80cm (41W), ø110cm (55W). There are two finishes: anodized black and anodized brass.





TECHNICAL DETAILS

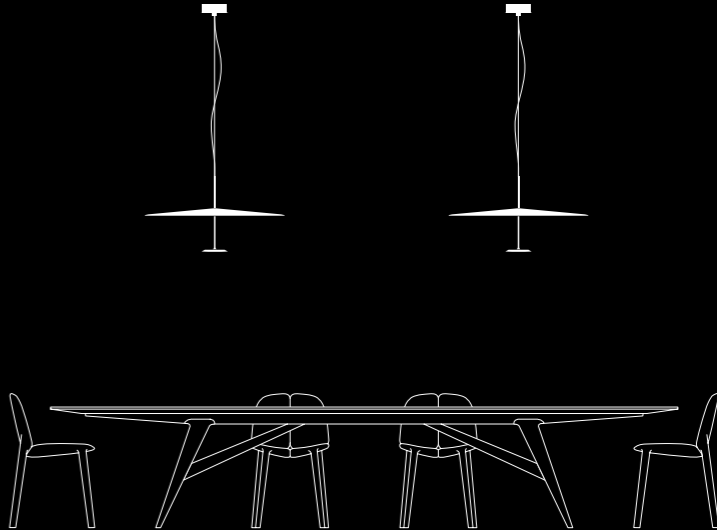

DIMENSIONS

DOT 1100

Code: 132

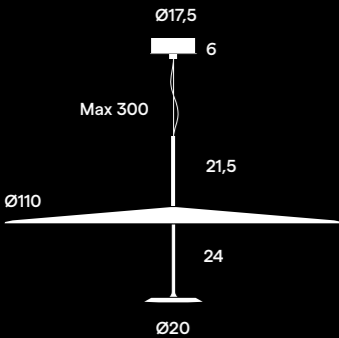

FINISHING

- Anodised Black
- Anodised Brass

LED SOURCE

Power:	52W	52W
CCT:	3000K	2700K
Emitted flux:	2020 lm	1950 lm
CRI:	>90	>90

TECHNICAL DATA

CRI
>90

CCT
2700K
3000K

A++

DALI
system

⊥

CE

ETL
us

High Colour Rendering Index
 Correlated Color Temperature 3000K or 2700K
 Energy Class A++
 Dimmable
 Dali system compatible
 Insulation Class I
 CE Listed
 ETL Listed

DIMENSIONS

DOT 800

Code: 131

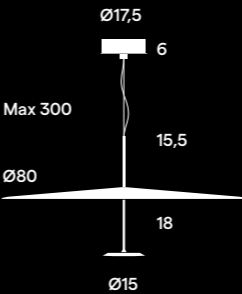

LED SOURCE

Power:	39W	39W
CCT:	3000K	2700K
Emitted flux:	1780 lm	1690 lm
CRI:	>90	>90

DOT 600

Code: 130

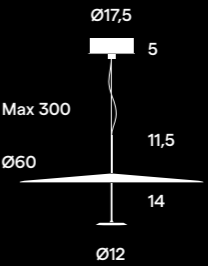

LED SOURCE

Power:	21W	21W
CCT:	3000K	2700K
Emitted flux:	893 lm	860 lm
CRI:	>90	>90



DOT LITE

In joining this Lumina family of lamps, the Dot Lite reprises the design of the original Dot. It was developed to provide cluster solutions for lighting and embellishing larger spaces whilst ensuring optimum distribution of light and easy personalization and adaptation to all kinds of ambience.

The Dot Lite is also characterized by its greater flexibility and ease of installation thanks to a new and smart system for electrically connecting the various components, making the lamp quicker and simpler to mount.

Having always been committed to sustainability and environmental responsibility and believing firmly in the “design for disassembly” approach, Lumina built its DOT Lite with just three components that are easy to dismantle.





In addition to the fully customizable Modular line, there are three pre-configured solutions:

- **Dot Lite Cluster 3**, with a round ceiling rose, three luminaires and an off-centring kit for correct ceiling anchorage;
- **Dot Lite Cluster 4**, with a round ceiling rose, four luminaires and an off-centring kit for correct ceiling anchorage;
- **Dot Lite Linear 3**, with a linear ceiling rose (length: 150 cm) and three luminaires.



TECHNICAL DETAILS

DOT LITE M

Code: 133M

DIMENSIONS

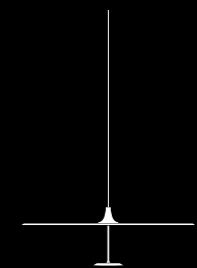
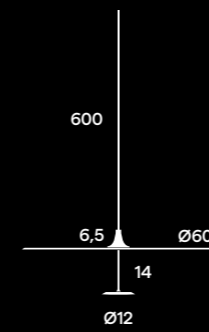

FINISHING

- Semi-glossy black
- Ultra-Matt white

LED SOURCE

Power:	12W	12W
CCT:	3000K	2700K
Emitted flux:	511 lm	495 lm
CRI:	>90	>90

24V AC-DC converter required

TECHNICAL DATA

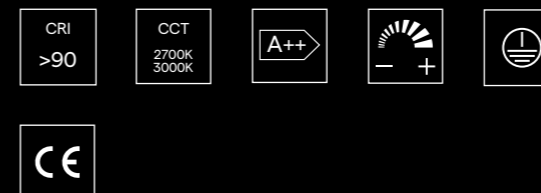

High Colour Rendering Index
 Correlated Color Temperature 3000K or 2700K
 Energy Class A++
 Dimmable
 Insulation Class I
 CE Listed

TECHNICAL DETAILS

DIMENSIONS

DOT LITE LINEAR 3

Code: 133L3

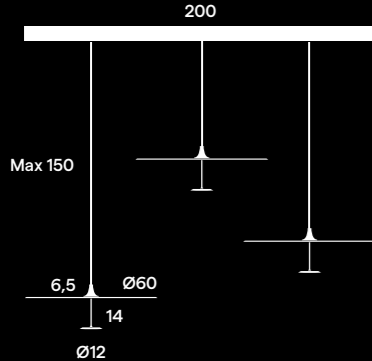

DOT LITE CLUSTER 3

Code: 133C3

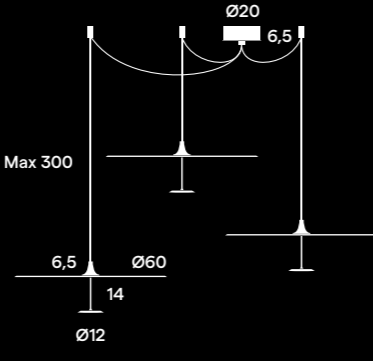

DIMENSIONS

DOT LITE CLUSTER 4

Code: 133C4

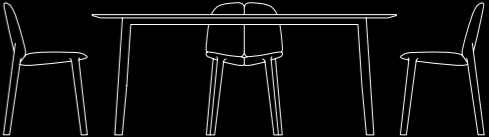
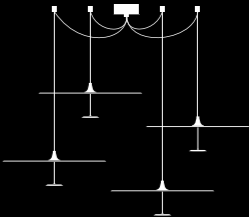
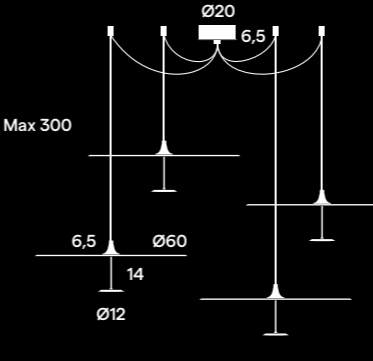

FINISHING

- Semi-glossy black
- Ultra-Matt white

LED SOURCE

Power:	3x12W	3x12W
CCT:	3000K	2700K
Emitted flux:	1533 lm	1485 lm
CRI:	>90	>90

FINISHING

- Semi-glossy black
- Ultra-Matt white

LED SOURCE

Power:	4x12W	4x12W
CCT:	3000K	2700K
Emitted flux:	2044 lm	1980 lm
CRI:	>90	>90

24V AC-DC converter required

TECHNICAL DATA

CRI >90

CCT 2700K 3000K

A++

DALI system

High Colour Rendering Index
 Correlated Color Temperature 3000K or 2700K
 Energy Class A++
 Dimmable
 Dali system compatible
 Insulation Class I
 CE Listed

TECHNICAL DATA

CRI >90

CCT 2700K 3000K

A++

DALI system

High Colour Rendering Index
 Correlated Color Temperature 3000K or 2700K
 Energy Class A++
 Dimmable
 Dali system compatible
 Insulation Class I
 CE Listed

82

83

ELLE
/TOMMASO CIMINI





ELLE LED

Elle is a series of floor-standing direct and indirect light lamps designed by the founder, Tommaso Cimini in 1984. It was the second project he worked on, straight after creating his masterpiece, the Daphine.

The Elle series has two versions: single arm and jointed arm in two segments. Both lamps are characterized by a mobile arm and a swivelling reflector with a special anti-glare grid on it.

With the advent of LEDs, Lumina decided to convert its classic halogen version to this technology whilst retaining the original forms and dimensions. In redesigning the lamp head and developing new optics and a new heat sink, Lumina gave the Elle a dual LED with a total of 45 W (a 25W LED for direct light + a 20W LED for indirect light), thus guaranteeing a powerful luminous flux and limited consumption.

In terms of illumination and glare, the Elle lamp is also well suited for use in workplaces with video terminals (UGR - Unified Glare Rating <19). The Elle LED's biggest advantage is the extreme uniformity of its light, whether direct or indirect, the latter minimizing shadows and contrasts.





TECHNICAL DETAILS

ELLE LED

Code: 60L

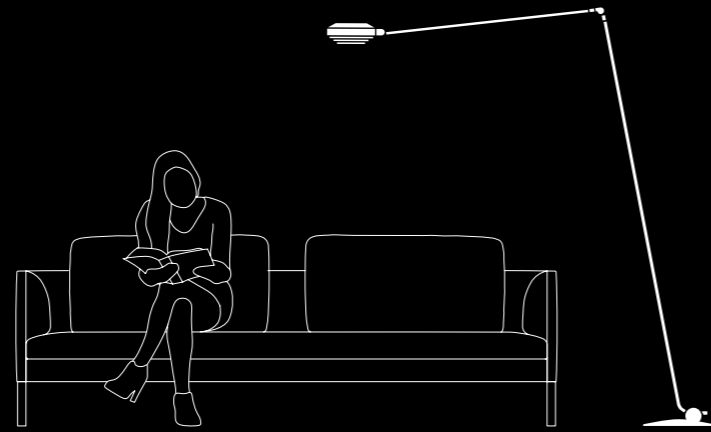

DIMENSIONS

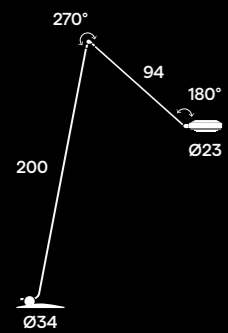

ACTIONS

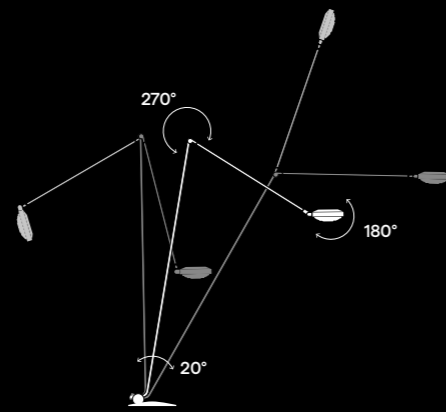

FINISHING

- Black soft-touch
- Matt white
- Red "Roma"
- Blue "Sapphire"
- Brushed nickel
- Metallic bronze

LED SOURCE

Power:	45W	45W
CCT:	3000K	2700K
Emitted flux:	2346 lm	2280 lm
CRI:	97	97

TECHNICAL DATA

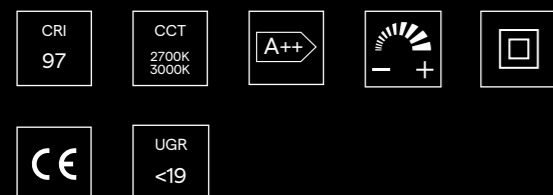

High Colour Rendering Index
Correlated Color Temperature 3000K or 2700K
Energy Class A++
Dimmable
Insulation Class II
CE Listed
Unified Glare Rating <19

ELLE 1 LED

Code: 61L

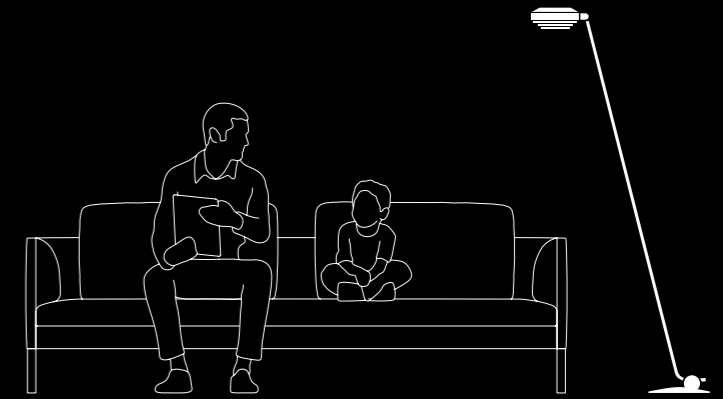

DIMENSIONS



ACTIONS

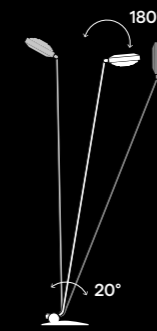

FINISHING

- Black soft-touch
- Matt white
- Red "Roma"
- Blue "Sapphire"
- Brushed nickel
- Metallic bronze

LED SOURCE

Power:	45W	45W
CCT:	3000K	2700K
Emitted flux:	2346 lm	2280 lm
CRI:	97	97

TECHNICAL DATA

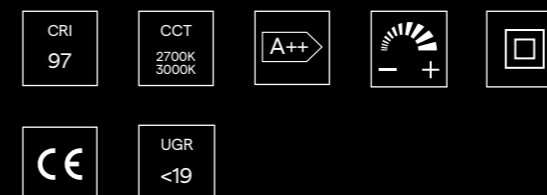

High Colour Rendering Index
Correlated Color Temperature 3000K or 2700K
Energy Class A++
Dimmable
Insulation Class II
CE Listed
Unified Glare Rating <19

EVA
/FOSTER+PARTNERS

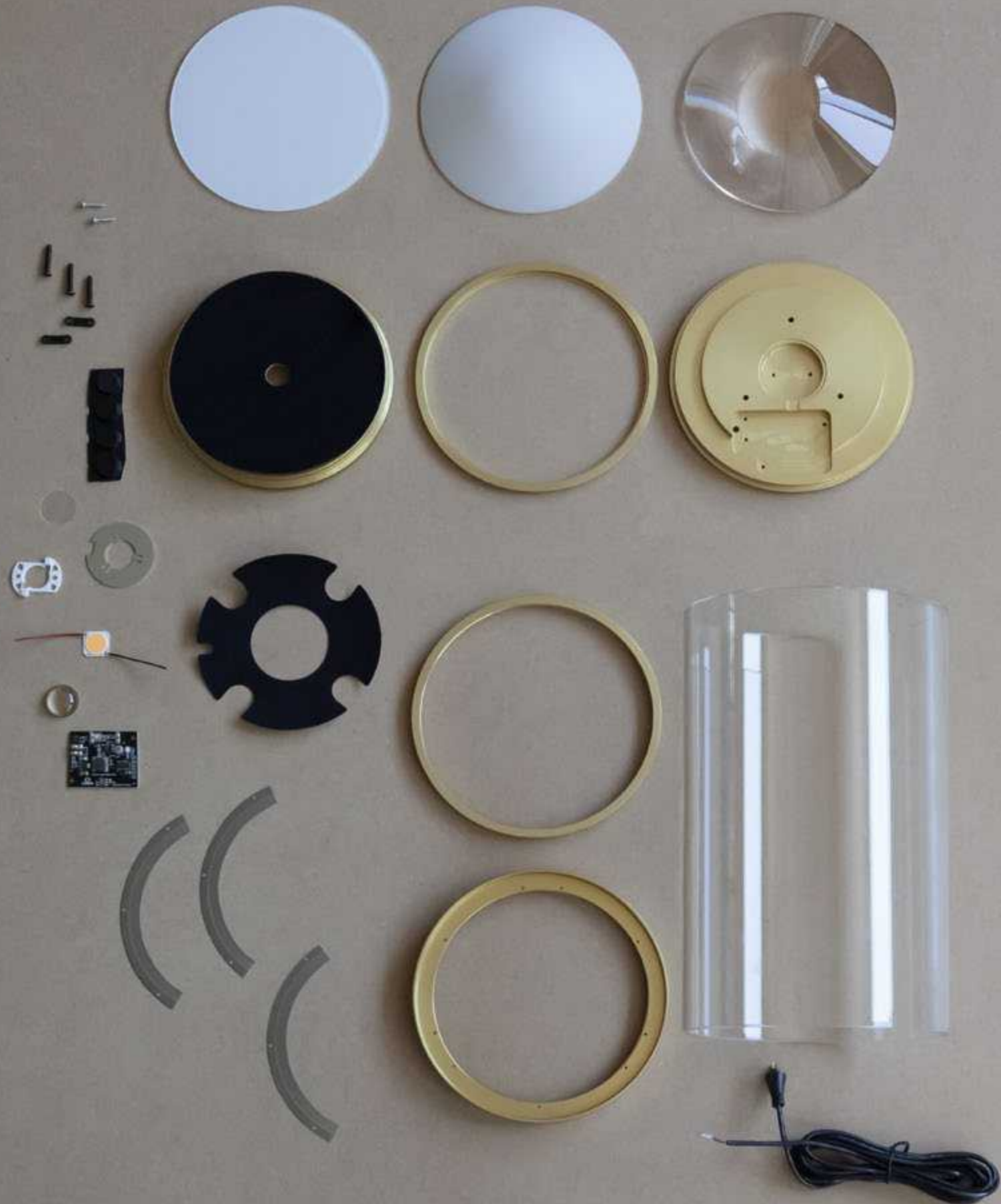



EVA

Designed by Foster + Partners, Eva is a free-standing lamp that meets the need for an indirect light that's easy to interact with. It can be placed in the middle of a round dining table, for example.

The idea was to create a cone of light, a subtle yet alluring flux similar to that of a candle, attractive and also useful. Eva has a turned aluminium base housing the electronic components, the LED and the optics, and a glass cylinder closed at the top by a conical diffuser.

The light flux is projected by way of a holographic filter, a small primary lens and a large secondary lens onto the upper opaline cone, while the LED source remains hidden.

Eva also has a tactile dimension: thanks to an encoder system (an infrared sensor to detect rotation) the intensity of the light can be precisely controlled by manually operating the ring on its base.





TECHNICAL DETAILS

EVA

Code: 140

DIMENSIONS

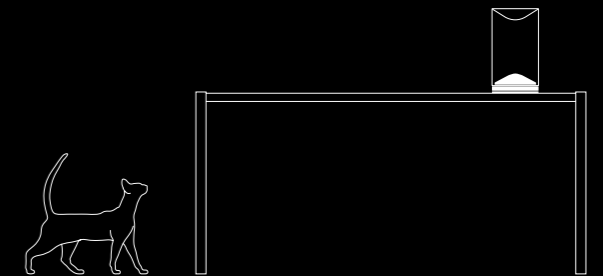
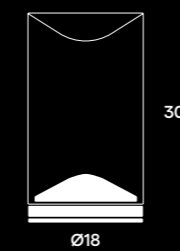

FINISHING

Anodised Black

Anodised Brass

LED SOURCE

Power:	18W	18W
CCT:	3000	2700
Emitted flux:	315 lm	305 lm
CRI:	97	97

TECHNICAL DATA



High Colour Rendering Index
 Correlated Color Temperature 3000K or 2700K
 Energy Class A++
 Dimmable
 Insulation Class III
 CE Listed
 ETL Listed



EVE

The Eva project also led to the creation of Eve, a free-standing lamp like its big sister but smaller and with a lower luminous power.

Eve is an indirect light: a high-performance 5W COB LED housed in the base concentrates its light through a PMMA lens onto the conical reflector above it, thus limiting direct glare.

The transparent cylinder defining Eve's profile is made of absolutely lead-free borosilicate glass. This kind of glass never loses its transparency or brilliance and is resistant to chemical agents and sudden changes in indoor and outdoor temperature. Not being porous, it does not harbour bacteria and is easy to clean with neutral detergents.

Lumina produces the base and all the metal parts (aluminium) with CNC (numerical control) lathes for maximum precision.

Finger-tip control of the light is provided by the touch dimmer mechanism on each point of the base ring: the first switches the lamp on, the second reduces the light to minimum and the third switches off.



TECHNICAL DETAILS

EVE

Code: 141

DIMENSIONS

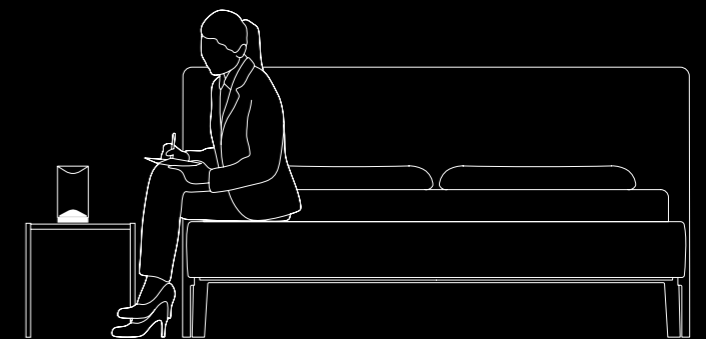
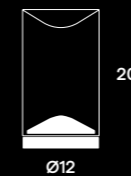

FINISHING



Black soft-touch



Anodised Brass

LED SOURCE

Power:	5W	5W
CCT:	3000	2700
Emitted flux:	70 lm	66 lm
CRI:	97	97v

TECHNICAL DATA



CRI
97



CCT
2700K
3000K



A++



- +



III



CE

High Colour Rendering Index
Correlated Color Temperature 3000K or 2700K
Energy Class A++
Dimmable
Insulation Class III
CE Listed

FLO
/FOSTER+PARTNERS

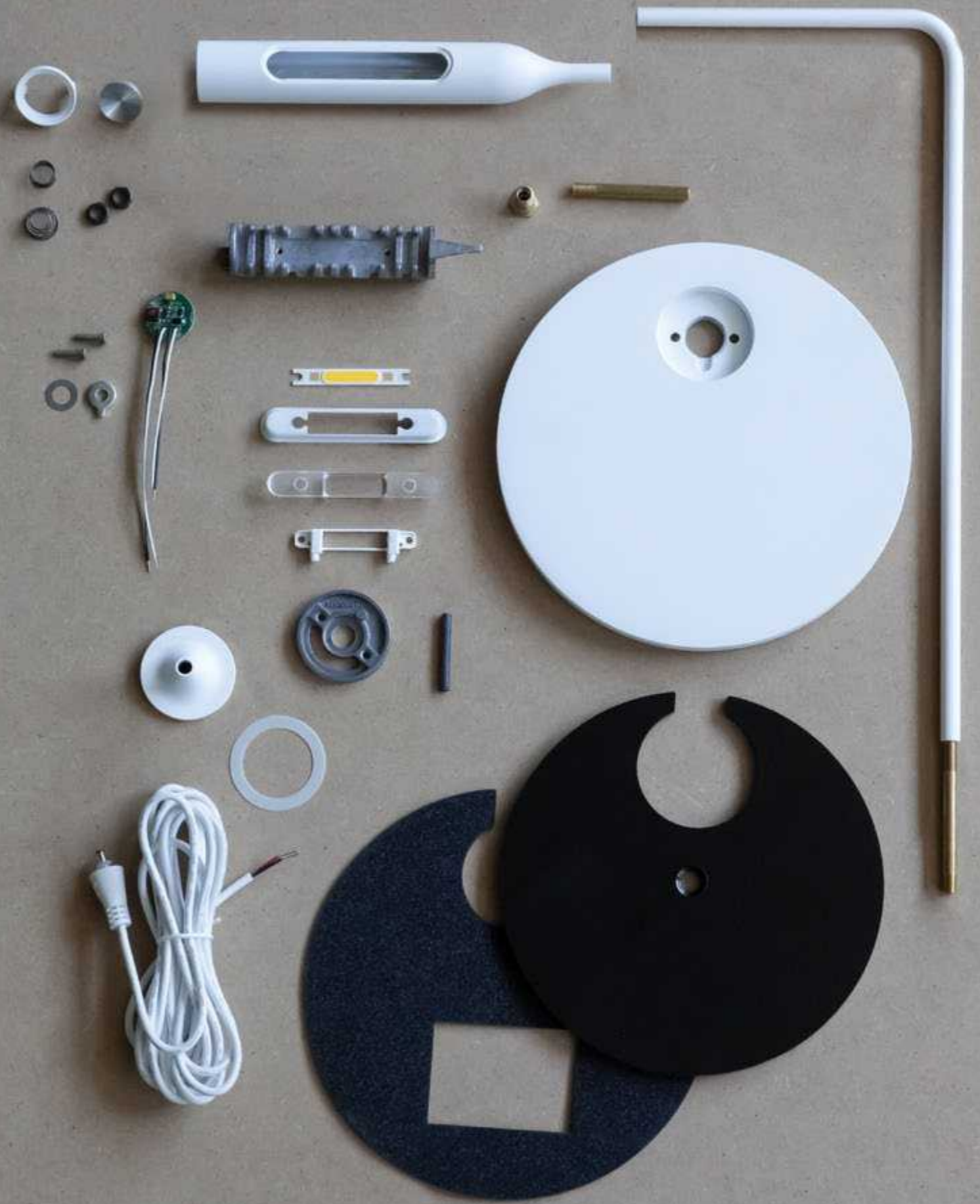



The Flo family is the fruit of the first collaboration between Lumina and the celebrated UK design firm Foster + Partners. Its minimalist, essential design expresses the company's style to perfection, its state-of-the-art LED technology being fully concealed beneath the structure's clean and subtle lines.

The defining features shared by all the Flo family are the cold-extruded cylindrical head and the lightweight aluminium body. Design has eliminated all superfluous elements, such as visible cabling or springs, to keep shapes and lines as minimalist as possible.

Further, all the lamps in the Flo family can generate light at two intensities, enabling them to be used both in places with little ambient lighting and where there is natural light but not enough to guarantee adequate visual comfort.



FLO DESK

The first lamp in the family, Flo Desk is the very essence of Lumina: “lots of light, not much lamp”.

Its design is a statement of essentials: the thin cylindrical head and lightweight but strong aluminium body are balanced by a round base, also made of aluminium.

An ideal lamp for spacious ambiences, the Flo Desk comes into its own where space is a key factor and light needs to be directed onto a level surface.

Recommended for smart-working or simply to enjoy reading a book.







TECHNICAL DETAILS

FLO DESK

Code: 940

DIMENSIONS

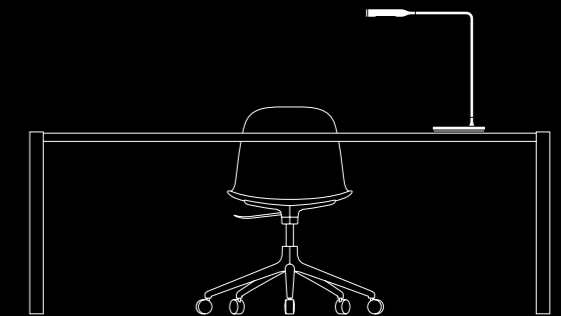
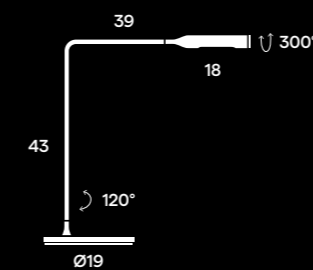

FINISHING

- | | | | |
|-----------------------|------------------|-----------------------|-----------------|
| <input type="radio"/> | Black soft-touch | <input type="radio"/> | Matt white |
| <input type="radio"/> | Matt red | <input type="radio"/> | Matt yellow |
| <input type="radio"/> | Brushed nickel | <input type="radio"/> | Metallic bronze |
| <input type="radio"/> | Gunmetal | | |

LED SOURCE

Power:	6W	6W
CCT:	3000	2700
Emitted flux:	370 lm	355 lm
CRI:	>90	>90

TECHNICAL DATA

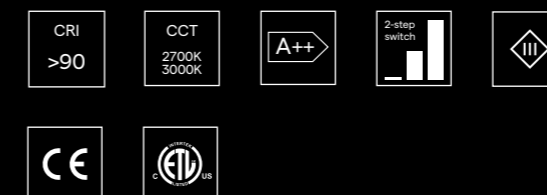

High Colour Rendering Index
 Correlated Color Temperature 3000K or 2700K
 Energy Class A++
 2 step switch
 Insulation Class III
 CE Listed
 ETL Listed





FLO BEDSIDE

This was developed to provide a lamp identical in shape to the Flo Desk, but lower in height and less powerful. The supporting arm, in fact, is 7 cm shorter than the Flo Desk's 43 cm, while the LED power has been reduced to 3W from the 6W of the Desk version.

The Flo Bedside was designed by Foster + Partners mainly for use in the home, its natural place being the bedroom bedside table, where it provides perfect light for reading but without being visually invasive.





TECHNICAL DETAILS

FLO BEDSIDE

Code: 950

DIMENSIONS

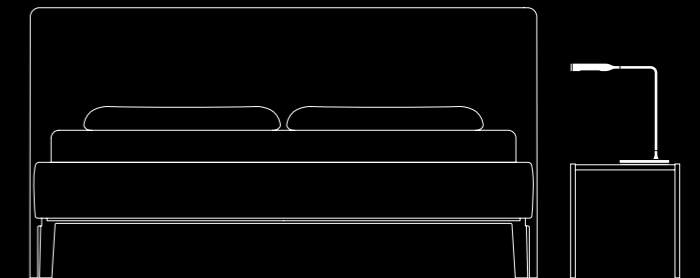
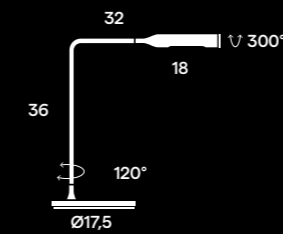

FINISHING

- Black soft-touch
- Matt white
- Matt red
- Matt yellow
- Brushed nickel
- Metallic bronze
- Gunmetal

LED SOURCE

Power:	3W	3W
CCT:	3000	2700
Emitted flux:	150 lm	140 lm
CRI:	>90	>90

TECHNICAL DATA

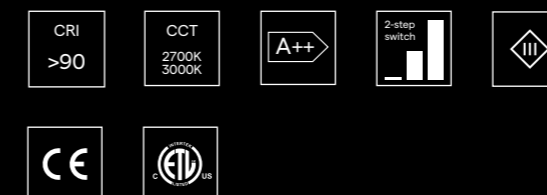

High Colour Rendering Index
 Correlated Color Temperature 3000K or 2700K
 Energy Class A++
 2 step switch
 Insulation Class III
 CE Listed
 ETL Listed



FLO FLOOR / FLO LOUNGE

In parallel with the table versions, Lumina and Foster+Partners developed two floor-standing lamps that reprise their defining characteristics.

The Flo Floor has a 6W LED (dual luminous power) and an arm height of 110 cm. The Flo Lounge has a 3W LED (dual luminous power) and an arm height of 100 cm.

Both versions have the same line, with the head adjustable through 300° and the arm rotating 120° over the base. The LED and heat sink, the latter worked on latest generation numerical control (CNC) machines, are concealed inside the head.

Flo Floor and Flo Lounge are suitable for both the home and public facilities such as lounge areas (as in the Kulm Eispavillon in St. Moritz, for example), airports, waiting rooms and hotel halls.

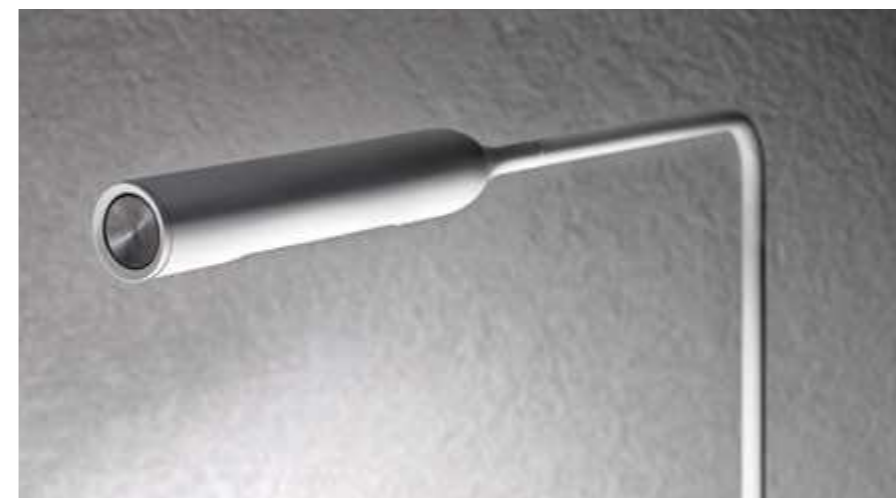





TECHNICAL DETAILS

FLO FLOOR

Code: 945

DIMENSIONS

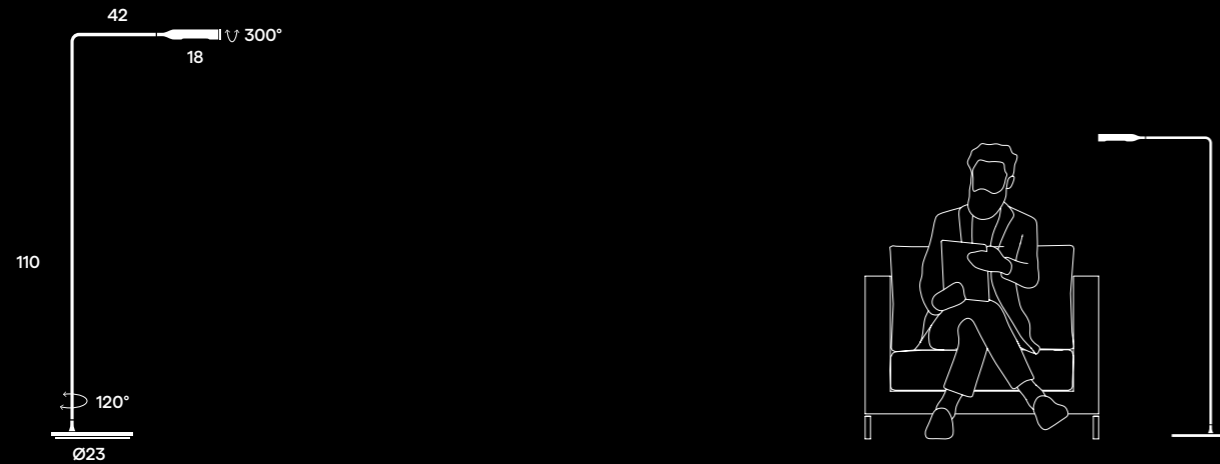

FINISHING

- Black soft-touch
- Matt white
- Matt red
- Matt yellow
- Brushed nickel
- Metallic bronze
- Gunmetal

LED SOURCE

Power:	6W	6W
CCT:	3000	2700
Emitted flux:	370 lm	355 lm
CRI:	>90	>90

TECHNICAL DATA

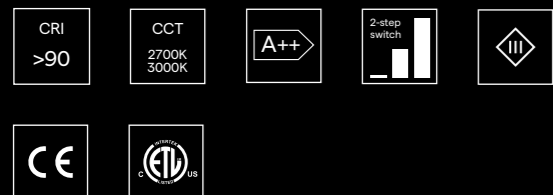

High Colour Rendering Index
Correlated Color Temperature 3000K or 2700K
Energy Class A++
2 step switch
Insulation Class III
CE Listed
ETL Listed

TECHNICAL DETAILS

FLO LOUNGE

Code: 971

DIMENSIONS

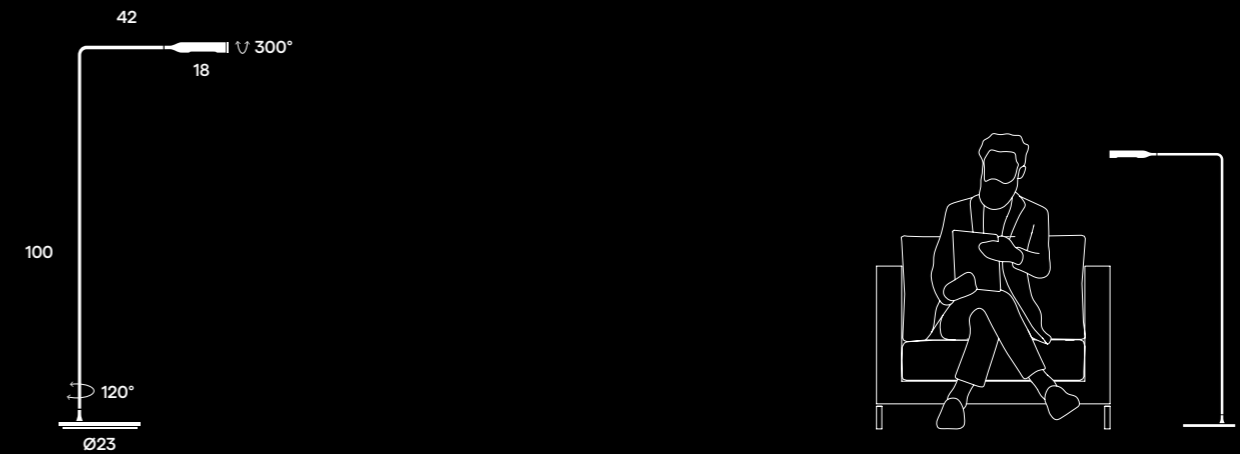

FINISHING

- Black soft-touch
- Matt white
- Matt red
- Matt yellow
- Brushed nickel
- Metallic bronze
- Gunmetal

LED SOURCE

Power:	3W	3W
CCT:	3000	2700
Emitted flux:	150 lm	140 lm
CRI:	>90	>90

TECHNICAL DATA

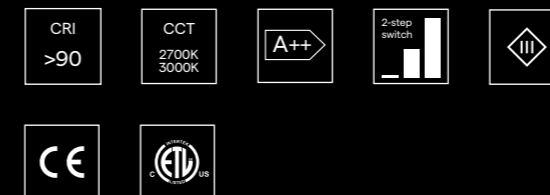

High Colour Rendering Index
Correlated Color Temperature 3000K or 2700K
Energy Class A++
2 step switch
Insulation Class III
CE Listed
ETL Listed



FLO WALL / FLO WALL M

To enrich and complete the Flo family, Lumina and Foster + Partners designed a wall version, it too with the minimalist profile characterizing all the members of the family.

The lamp is intended for places where concentrated light is needed but must not disturb those close to it. One of the main applications is the bed head or wall over bedside tables.

The difference between the Wall and the Wall M versions is that the latter does not have a visible power cable.





TECHNICAL DETAILS

FLO WALL / WALL M

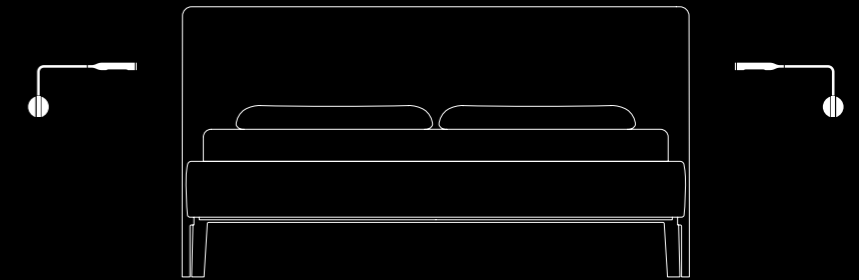

DIMENSIONS

Model: Wall

Code: 975

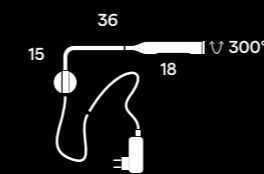

DIMENSIONS

Model: Wall M

Code: 976

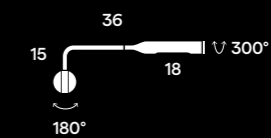

24V AC-DC converter required

FINISHING

- | | | | |
|-----------------------|-------------------------|-----------------------|------------------------|
| <input type="radio"/> | Black soft-touch | <input type="radio"/> | Matt white |
| <input type="radio"/> | Matt red | <input type="radio"/> | Matt yellow |
| <input type="radio"/> | Brushed nickel | <input type="radio"/> | Metallic bronze |
| <input type="radio"/> | Gunmetal | | |

LED SOURCE

Power:	3W	3W
CCT:	3000	2700
Emitted flux:	150 lm	140 lm
CRI:	>90	>90

TECHNICAL DATA

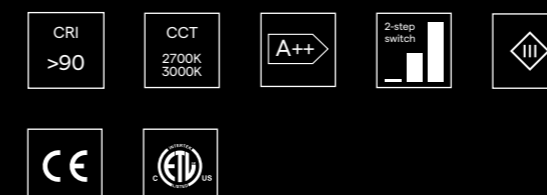

High Colour Rendering Index
 Correlated Color Temperature 3000K or 2700K
 Energy Class A++
 2 step switch
 Insulation Class III
 CE Listed
 ETL Listed



FLO GROMMET

Based on the Desk version, the Flo Grommet is particularly suitable for public spaces like libraries, co-working facilities and bookshops, given its extreme versatility in terms of worktop installation.

It can be anchored directly to a worktop in fact, to help optimize use of space. Its 39 cm arm turns through 120° over the base to guarantee maximum flexibility.

Available in two versions (F20 and F46), according to the drill diameter and the thickness of the surface of installation.





TECHNICAL DETAILS

FLO GROMMET

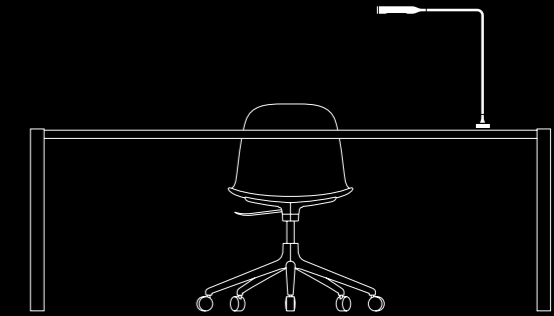

DIMENSIONS

Model: F46

Code: 960

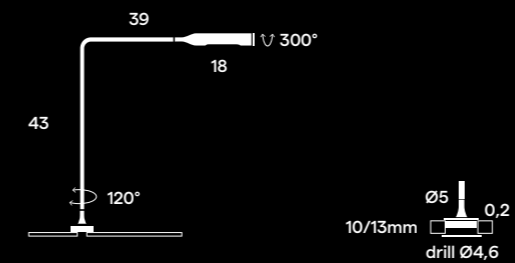

FINISHING

- | | | | |
|-----------------------|-------------------------|-----------------------|------------------------|
| <input type="radio"/> | Black soft-touch | <input type="radio"/> | Matt white |
| <input type="radio"/> | Matt red | <input type="radio"/> | Matt yellow |
| <input type="radio"/> | Brushed nickel | <input type="radio"/> | Metallic bronze |
| <input type="radio"/> | Gunmetal | | |

TECHNICAL DATA

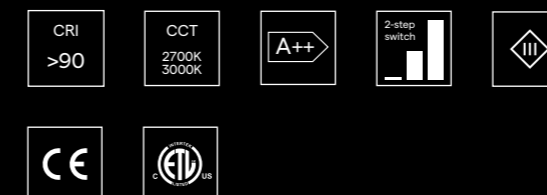

DIMENSIONS

Model: F20

Code: 962

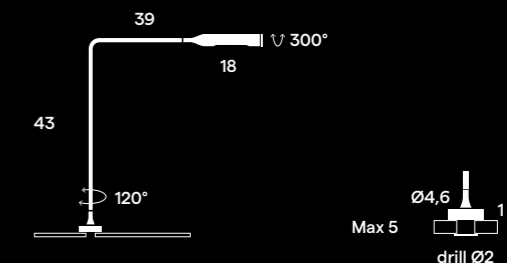

LED SOURCE

Power:	6W	6W
CCT:	3000	2700
Emitted flux:	370 lm	355 lm
CRI:	>90	>90

High Colour Rendering Index
 Correlated Color Temperature 3000K or 2700K
 Energy Class A++
 2 step switch
 Insulation Class III
 CE Listed
 ETL Listed



FLO CLAMP

Flo Clamp is characterized by its handy clamp on the base, which earns space without sacrificing any of Flo's minimalist elegance.

The clamp can be attached and screwed into a table top up to 4.7 cm thick.

The 300° adjustable head and the arm turning through 360° guarantee maximum flexibility of use and wide-reaching light.



TECHNICAL DETAILS

FLO CLAMP

Code: 955

DIMENSIONS

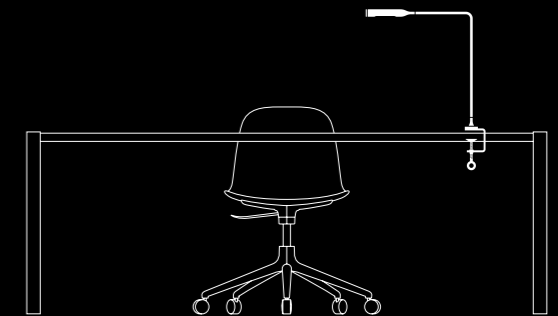
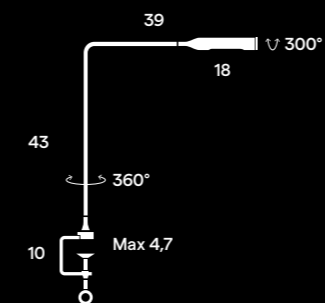

FINISHING

- Black soft-touch
- Matt red
- Brushed nickel
- Gunmetal
- Matt white
- Matt yellow
- Metallic bronze

LED SOURCE

Power:	6W	6W
CCT:	3000	2700
Emitted flux:	370 lm	355 lm
CRI:	>90	>90

TECHNICAL DATA

CRI
>90

CCT
2700K
3000K

A++

2-step
switch

III

CE

ETL
USA

High Colour Rendering Index
 Correlated Color Temperature 3000K or 2700K
 Energy Class A++
 2 step switch
 Insulation Class III
 CE Listed
 ETL Listed

LIMBUS
/EMANUELE RICCI





LIMBUS

The Limbus is a direct light pendant lamp designed by Emanuele Ricci. It looks like a small luminous planet shining its light downwards.

This lamp is a perfect synthesis of form and function, in which optics, thermodynamics, glass engineering and precision metal working combine to create a pure and essential product in the most authentic Lumina style.

It consists of a glass sphere (ø 12cm) and an aluminium ring that horizontally separates the two hemispheres.



The hemispheres are made of high thickness Bohemian patterned glass. The bottom hemisphere is the optical component (lens) and protects the light source. It was engineered to produce direct light shining downward at an angle of 60°, enabling the lamp to be looked at in all its magical appeal without the slightest glare outside the cone of light itself.

The top hemisphere is designed to protect the internal components against external agents such as dust and insects. The central 3-spoke aluminium ring is made in-house using latest generation numerical control (CNC) lathes.

The nucleus houses the LED (CRI 97), the heat sink (working temperature: 70° C) and the holographic filter, responsible for producing more uniform light.



In addition to the Modular line, which allows all Limbus's potential to be exploited for fully personalized solutions, the following pre-configured options are available:

- **Limbus Cluster 3:** with a round rosette (diameter: 17.5 cm), three luminaires and a decentring kit for correct anchorage to the ceiling;
- **Limbus Cluster 5:** with a round rosette (diameter: 20 cm), five luminaires and a decentring kit for correct anchorage to the ceiling;
- **Limbus Linear 3:** with a linear rosette (length: 150 cm) and three luminaires;
- **Limbus Linear 5:** with a linear rosette (length: 200 cm) and five luminaires.





TECHNICAL DETAILS

LIMBUS

Code: 190

DIMENSIONS



FINISHING

○ Anodised Black ● Anodised Brass

LED SOURCE

Power:	4,5W	4,5W
CCT:	3000	2700
Emitted flux:	350 lm	330 lm
CRI:	97	97

TECHNICAL DATA

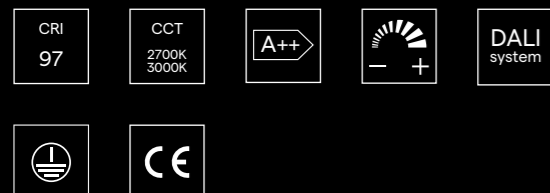

High Colour Rendering Index
Correlated Color Temperature 3000K or 2700K
Energy Class A++
Dimmable
Dali system compatible
Insulation Class I
CE Listed

TECHNICAL DETAILS

LIMBUS M

Code: 190M

DIMENSIONS

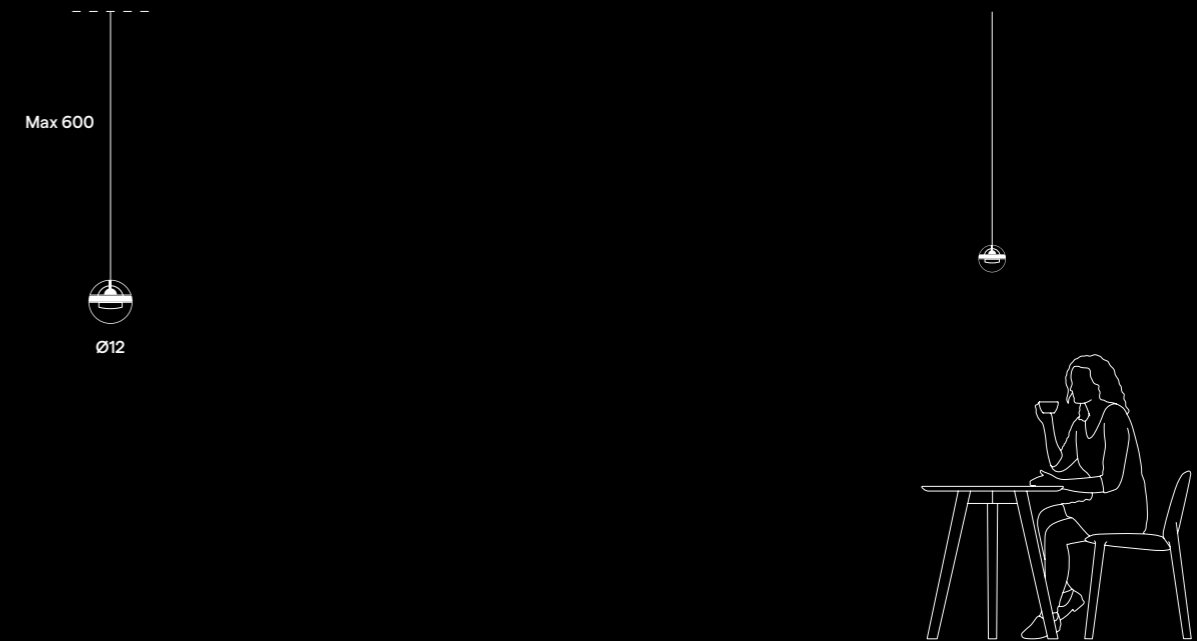

FINISHING

○ Anodised Black ● Anodised Brass

LED SOURCE

Power:	4,5W	4,5W
CCT:	3000	2700
Emitted flux:	350 lm	330 lm
CRI:	97	97

24V AC-DC converter required

TECHNICAL DATA

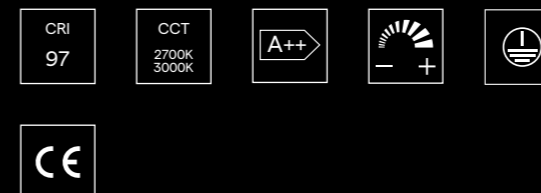

High Colour Rendering Index
Correlated Color Temperature 3000K or 2700K
Energy Class A++
Dimmable
Insulation Class I
CE Listed

TECHNICAL DETAILS

LIMBUS

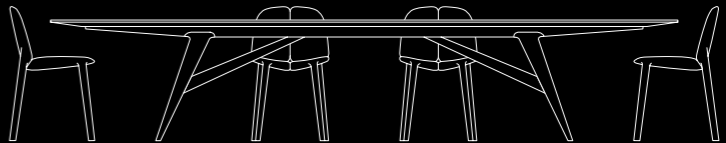
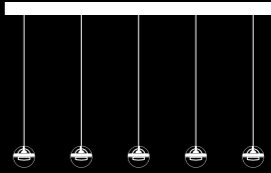

DIMENSIONS

LIMBUS CLUSTER 3

Code: 190C3

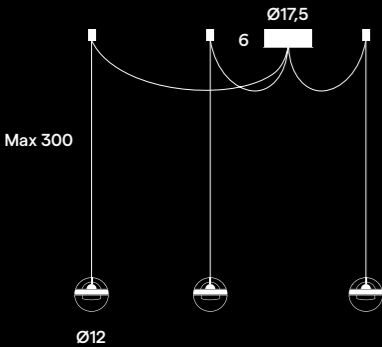

LIMBUS LINEAR 3

Code: 190L3

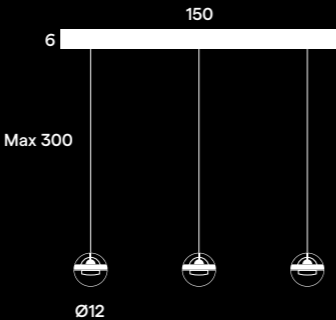

LIMBUS CLUSTER 5

Code: 190C5

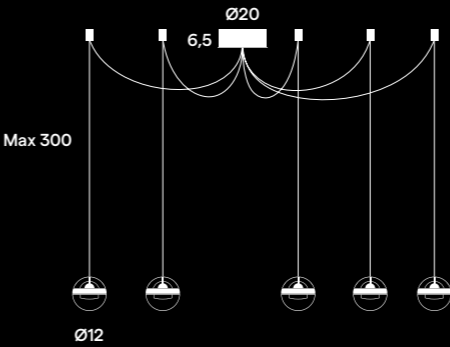

LIMBUS LINEAR 5

Code: 190L5

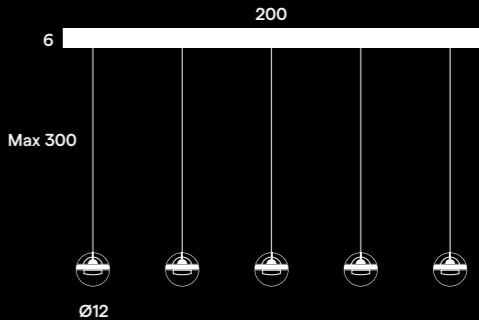

FINISHING

- Anodised Black
- Anodised Brass

LED SOURCE

Power:	3x4,5W	3x4,5W
CCT:	3000	2700
Emitted flux:	1050 lm	990 lm
CRI:	97	97

FINISHING

- Anodised Black
- Anodised Brass

LED SOURCE

Power:	5x4,5W	5x4,5W
CCT:	3000	2700
Emitted flux:	1750 lm	1650 lm
CRI:	97	97

TECHNICAL DATA

CRI
97

CCT
2700K
3000K

A++

DALI
system

CE

High Colour Rendering Index
 Correlated Color Temperature 3000K or 2700K
 Energy Class A++
 Dimmable
 Dali system compatible
 Insulation Class I
 CE Listed

TIA
/FOSTER+PARTNERS





TIA 200

Tia 200 is the latest pendant light designed for Lumina by the famous London firm of architects Foster+Partners. It's characterized by simple and balanced forms: the inspired harnessing of technology to a minimalist aesthetic makes this lamp a timeless object.

Expressing Lumina's insistence on the recyclability of every component, the Tia 200 is completely disassemblable and the body of the lamp (glass shade, recyclable PMMA lens and aluminium structure) is totally recyclable.

Concealed within the Tia 200's simple forms is a triumph of technology. The lamp's Lumina-designed central optical unit, in turned satin-finish PMMA, was developed to guarantee uniform diffusion of the beam and prevent annoying glare and light/shadow contrasts.

The filter on the bottom of the unit, a photo-engraved brass plate, reduces glare to ensure a pleasant effect not only on the illuminated surfaces but also when looking at the lamp itself.



On the outside, the lamp is an exquisite white overlay blown glass hemisphere, slightly oblate, with a special satin-effect finish. The glass (3-ply, 2.5 mm thick) was developed and is produced wholly in Italy.

Another highly important feature of this lamp is its heat sink, developed and produced by Lumina in-house. It keeps the temperature of the LED below 80° C (at 25° C room temperature).

Both the heat sink and the lamp's central structure are in aluminium turned on latest generation numerical control (CNC) lathes.

The lamp is fitted with a special filter on its upper part to prevent accumulation of dust, insects and other substances capable of soiling the glass and producing inaesthetic marks on the inside of the shade.





In addition to the Modular line making it possible to exploit all the Tia 200's potential for fully personalizable solutions, the following pre-configured options are also available:

- **Tia 200 Cluster 3:**
with a round rosette (diameter: 20 cm), three luminaires and a decentring kit for correct anchorage to the ceiling;
- **TIA 200 Cluster 5:**
with a round rosette (diameter: 20 cm), five luminaires and a decentring kit for correct anchorage to the ceiling;
- **TIA 200 Linear 3:**
with a linear rosette (length: 150 cm) and three luminaires;
- **TIA 200 Linear 5:**
with a linear rosette (length: 200 cm) and five luminaires.

TECHNICAL DETAILS

TIA

Code: 180

DIMENSIONS



FINISHING

● White glass

LED SOURCE

Power:	4,5W	4,5W
CCT:	3000	2700
Emitted flux:	270 lm	258 lm
CRI:	97	97

TECHNICAL DATA

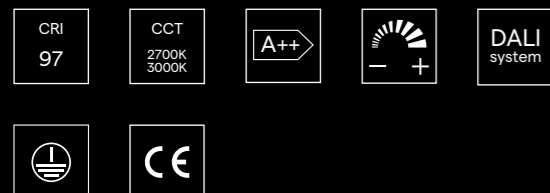

High Colour Rendering Index
Correlated Color Temperature 3000K or 2700K
Energy Class A++
Dimmable
Dali system compatible
Insulation Class I
CE Listed

TECHNICAL DETAILS

TIA M

Code: 180M

DIMENSIONS



FINISHING

● White glass

LED SOURCE

Power:	4,5W	4,5W
CCT:	3000	2700
Emitted flux:	270 lm	258 lm
CRI:	97	97

24V AC-DC converter required

TECHNICAL DATA

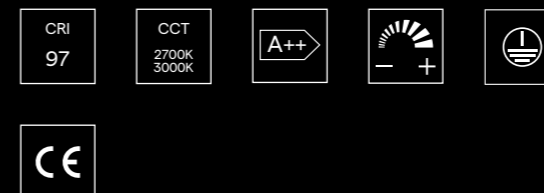

High Colour Rendering Index
Correlated Color Temperature 3000K or 2700K
Energy Class A++
Dimmable
Insulation Class I
CE Listed

TECHNICAL DETAILS

TIA

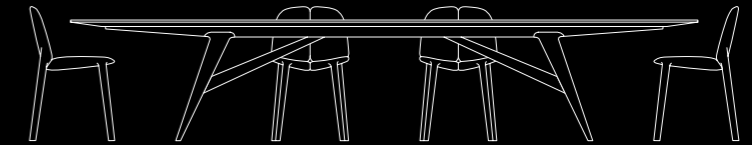
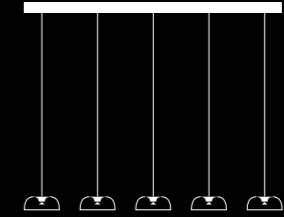

DIMENSIONS

TIA CLUSTER 3

Code: 180C3

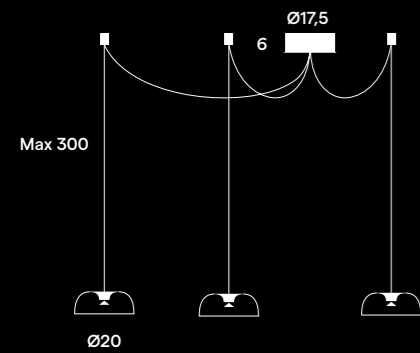

TIA LINEAR 3

Code: 180L3

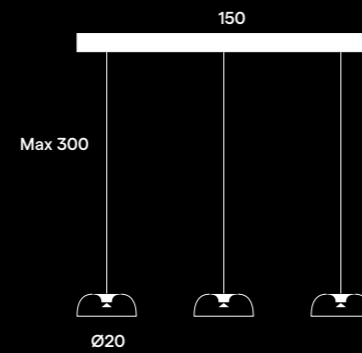

TIA CLUSTER 5

Code: 180C5

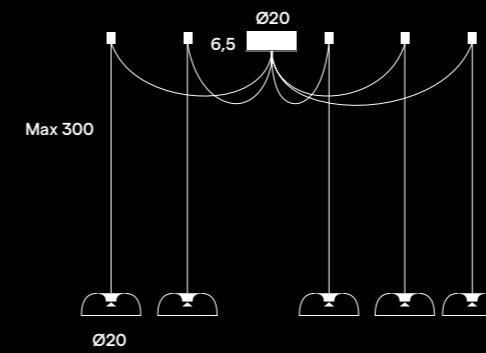

TIA LINEAR 5

Code: 180L5

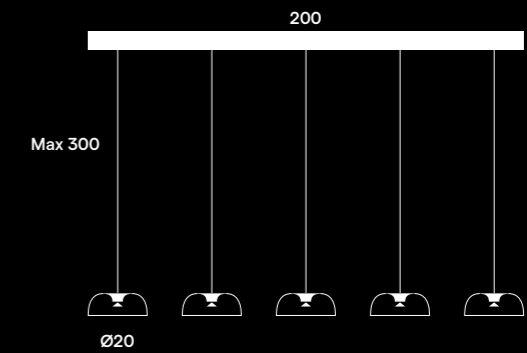

FINISHING

● White glass

LED SOURCE

Power:	3x4,5W	3x4,5W
CCT:	3000	2700
Emitted flux:	810 lm	774 lm
CRI:	97	97

FINISHING

● White glass

LED SOURCE

Power:	5x4,5W	5x4,5W
CCT:	3000	2700
Emitted flux:	1350 lm	1290 lm
CRI:	97	97

TECHNICAL DATA

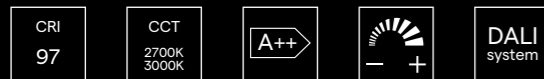

High Colour Rendering Index
Correlated Color Temperature 3000K or 2700K
Energy Class A++
Dimmable
Dali system compatible
Insulation Class I
CE Listed





INTEGRATED LED

LED BULBS



FLIP

/HEINRICH WIEDERHOLD





FLIP 22

How do you light a table when there's no power outlet over its centre point? With the design of the Flip 22 ceiling lamp, Heinrich Wiederhold solved a rather common problem: the Flip 22 adapts to off-centre power outlets in the ceiling, making it possible to directly illuminate the table thanks to its wide range of action and flexibility.

This lamp's defining feature is its telescopic arm, which has a spherical swivel at each end enabling it to occupy a wide variety of positions and shine light where needed.

The Flip 22 provides sharp, precise light that can be directed at will thanks to the telescopic arm's range of action (up to 65 cm) and adjustable length (from 94 to 140 cm).

Thanks to its ease of use, the Flip 22 can be installed not only in the dining area but also over a desk in a study, for example, or over a coffee table in a living room.





TECHNICAL DETAILS

FLIP

Code: 22

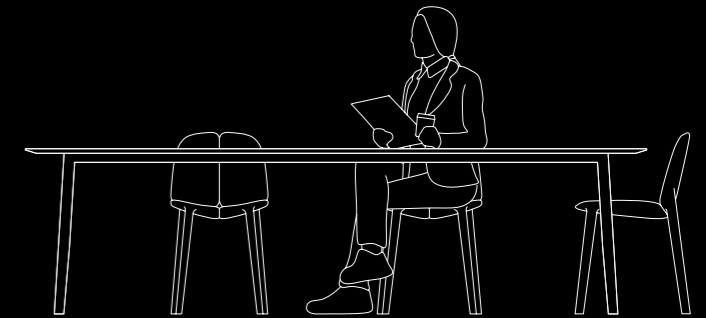
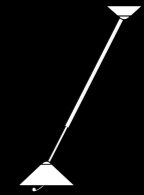

DIMENSIONS

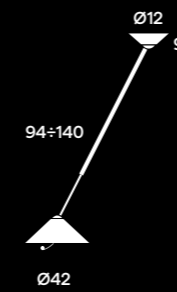

ACTIONS

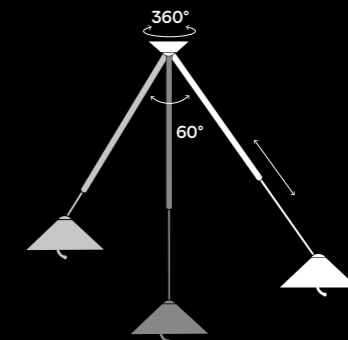

FINISHING

- Matt white
- Brushed nickel

- Anodised aluminium

HALOGEN SOURCE

Power: MAX 150W HAL [E27]

TECHNICAL DATA



LED bulbs compatible
 Dimmable (according to installed bulbs)
 Bulbs not included
 Energy class A++ compatible
 Insulation Class I
 CE Listed

MATRIX

/YAACOV KAUFMAN



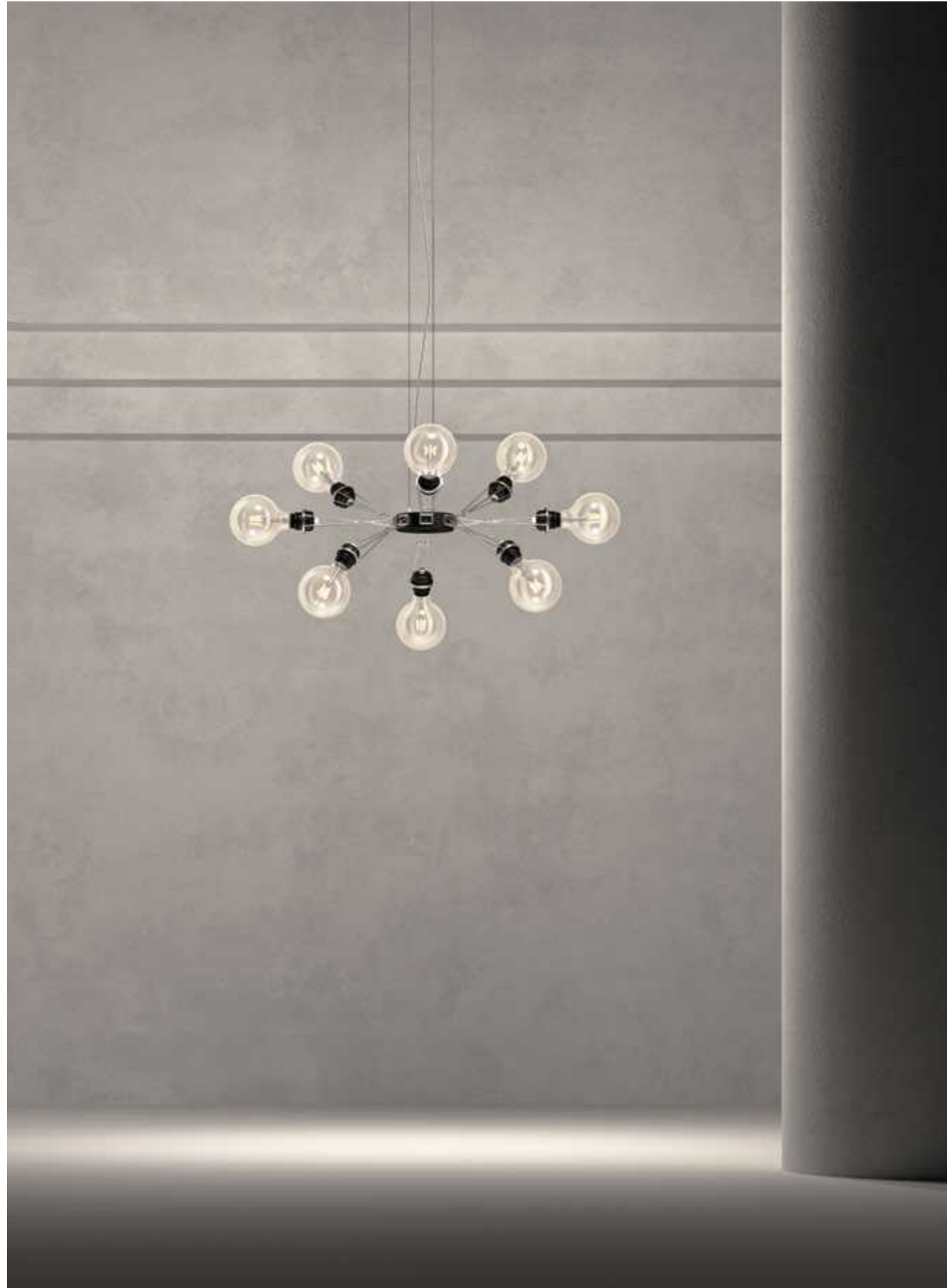

This is a broad family of lamps characterized by special adjustable arms and based on designer Yaacov Kaufman's research into the friction mechanism.

Thanks to the mobile metal arms, Matrix lamps make it possible to freely configure the positions of the luminaires at each end.



MATRIX DOPPIA

In postmodern style, the Matrix Doppia pendant lamp offers total versatility with its 16 mobile arms.

Each arm can be positioned separately to create the most diverse lighting configurations. The arms are arranged in two groups of eight for balanced compositions.

The Matrix Doppia is made of stainless steel with a nickel-plated canopy element in the middle.



MATRIX OTTO

A pendant lamp whose huge expressive impact lies in the original composition of its eight thin steel arms. Tracing the shape of a star, they look like a mechanical octopus with E27 lightbulb fittings on the ends of its 'tentacles'. In this way, light is emitted in all directions.

The Matrix Otto gives the user great freedom to direct light: however the arms are arranged, the lamp emits its light uniformly.

This direct light makes it particularly useful in living rooms, where its striking aesthetic impact is another plus.

Given its personality and wide-reaching flux, it's also ideal for installation in large rooms, halls, galleries and exhibition spaces in general.





MATRIX OTTO P

Identical in dimensions to the Otto but without a hanging cable, this version was designed to be fixed directly to a wall or ceiling.

Made of an aluminium and steel alloy, it has a central body with eight adjustable arms, each having an E27 fitting for LED bulbs.



MATRIX MONO

A single-arm version to mount on a wall by means of a round fixture. Recommended for small spaces.



TECHNICAL DETAILS

MATRIX OTTO

Code: 385

DIMENSIONS

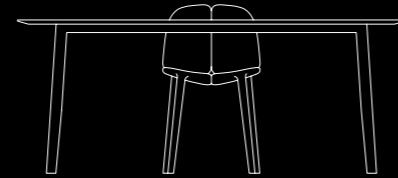
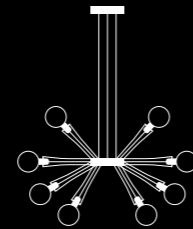
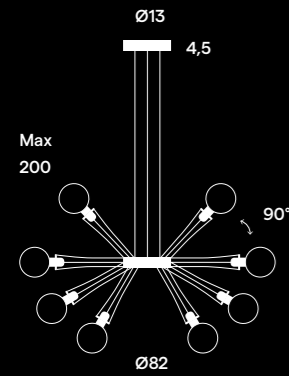

FINISHING

- Black soft touch
- Brushed nickel

HALOGEN SOURCE

Power: MAX 8x60W HAL [E27/E26]

TECHNICAL DATA



LED bulbs compatible
Dimmable (according to installed bulbs)
Bulbs not included
Energy class A++ compatible
Insulation Class I
CE Listed



TECHNICAL DETAILS

MATRIX DOPPIA

Code: 387

DIMENSIONS

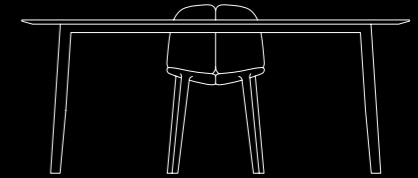
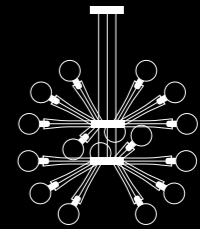
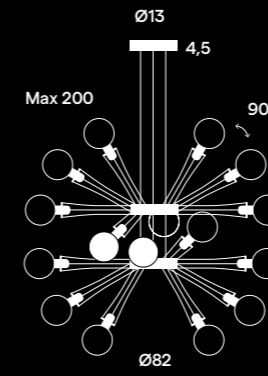

FINISHING

- Black soft touch
- Brushed nickel

HALOGEN SOURCE

Power: MAX 16x60W HAL [E27/E26]

TECHNICAL DETAILS

MATRIX OTTO P

Code: 389

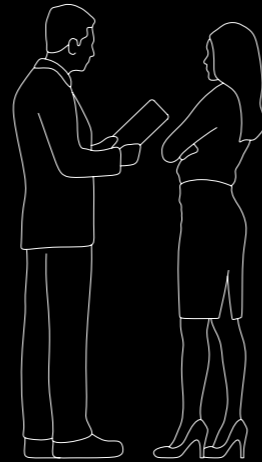
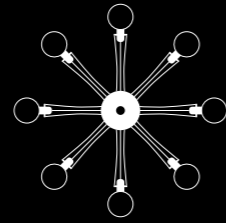

TECHNICAL DETAILS

MATRIX MONO

Code: 395

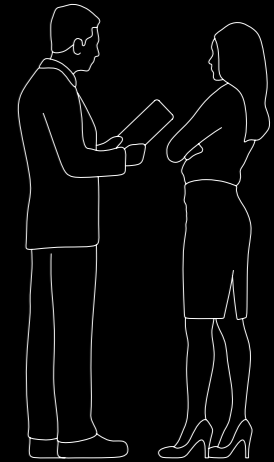

DIMENSIONS

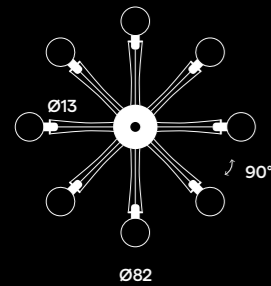

ACTIONS

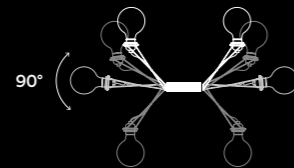

DIMENSIONS

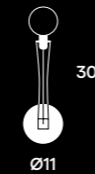

ACTIONS

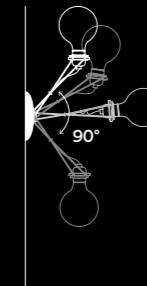

FINISHING

- Black soft touch
- Brushed nickel

HALOGEN SOURCE

Power: MAX 8x60W HAL [E27/E26]

FINISHING

- Black soft touch
- Brushed nickel

HALOGEN SOURCE

Power: MAX 60W HAL [E27/E26]

TECHNICAL DATA



LED bulbs compatible
Dimmable (according to installed bulbs)
Bulbs not included
Energy class A++ compatible
Insulation Class I
CE Listed

MOOVE
/FRANCESCO BRAMBILLA





MOOVE

This innovative ceiling lamp consists of a cylindrical shade hanging from a rotating arm mounted on a carbon fibre rail.

Designed by Francesco Brambilla, it provides a functional and aesthetically pleasing solution for ceiling power outlets in difficult or unfavourable positions.

The lamp's name, Moove, was suggested by its extraordinary flexibility.

Thanks to the shape of the shade (diameter: 42.5 cm; E27 bulb), Moove provides a downward spotlight and soft lighting to guarantee maximum comfort.





The value added of this lamp is the innovative movement of the shade along its 125 cm rail, on which it can slide freely. The arm itself can be turned through 350° and can therefore be pointed in all directions. The shade can be height-adjusted to a maximum of 195 centimetres below the ceiling.

Available in three different versions:

- Moove**
- Moove Doppia**
- Moove Mono**



TECHNICAL DETAILS

MOOVE

Code: 750

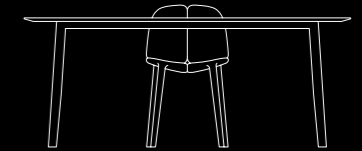
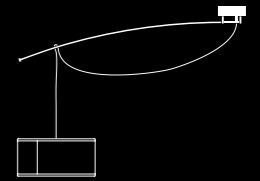

DIMENSIONS

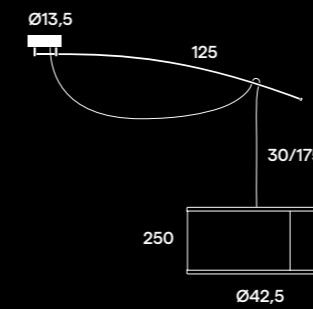

ACTIONS

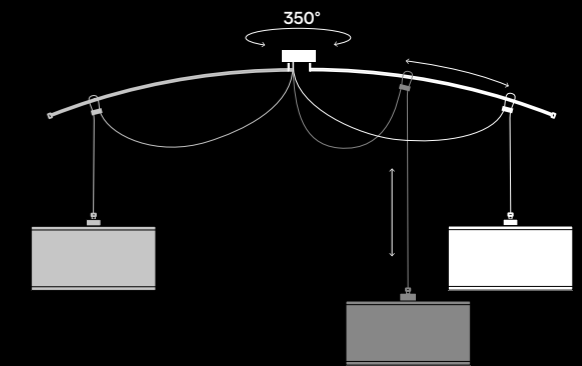

FINISHING

- Black soft-touch

HALOGEN SOURCE

Power: MAX 75W HAL [E27/E26]

TECHNICAL DATA



LED bulbs compatible
 Dimmable (according to installed bulbs)
 Bulbs not included
 Energy class A++ compatible
 Insulation Class I
 CE Listed

TECHNICAL DETAILS

MOOVE DOPPIA

Code: 751

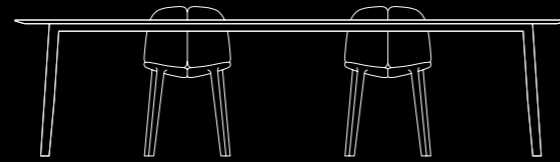
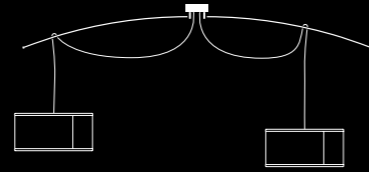

DIMENSIONS

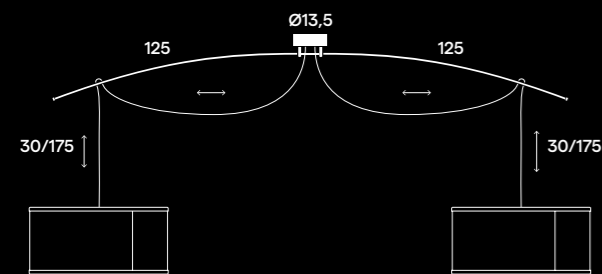

ACTIONS

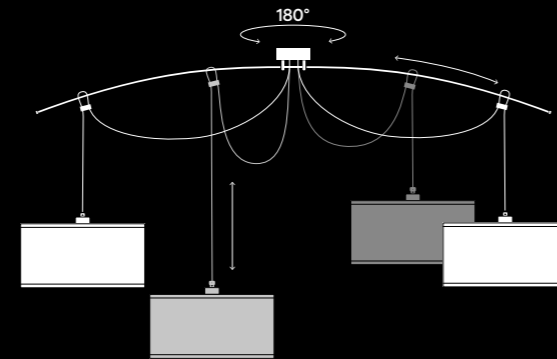

FINISHING

○ Black soft-touch

HALOGEN SOURCE

Power: MAX 2x75W HAL [E27/E26]

TECHNICAL DATA



LED bulbs compatible
Dimmable (according to installed bulbs)
Bulbs not included
Energy class A++ compatible
Insulation Class I
CE Listed



TECHNICAL DETAILS

MOOVE MONO

Code: 752

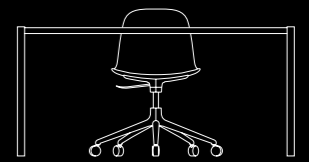
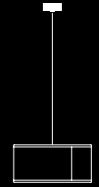

DIMENSIONS

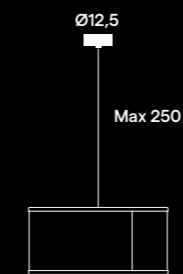

FINISHING

○ Black soft-touch

HALOGEN SOURCE

Power: MAX 75W HAL [E27/E26]

TECHNICAL DATA



LED bulbs compatible
Dimmable (according to installed bulbs)
Bulbs not included
Energy class A++ compatible
Insulation Class I
CE Listed



NAOMI

/YAACOV KAUFMAN





NAOMI

Naomi is a series of aluminium lamps designed by Yaacov Kaufman. They have an arm and reflector that turn through 360°, to use with a classic round base or various other fittings (clamp, wall fixture and jointing connector).

With these Naomi lamps, Lumina has achieved absolute cleanness and purity of line by eliminating all visible mechanisms.

It's the arm's soft curves that make every movement possible. Lumina has patented a system, in fact, that operates on the structure of the lamp in such a way that movement of the arm is controlled by the arm itself.

The various versions of Naomi – tavolo, terra, parete, morsetto, pinza – enable the lamp to be used in all kinds of ambience. Features shared by all the Naomi family include the compact reflector and the arm's central friction mechanism.

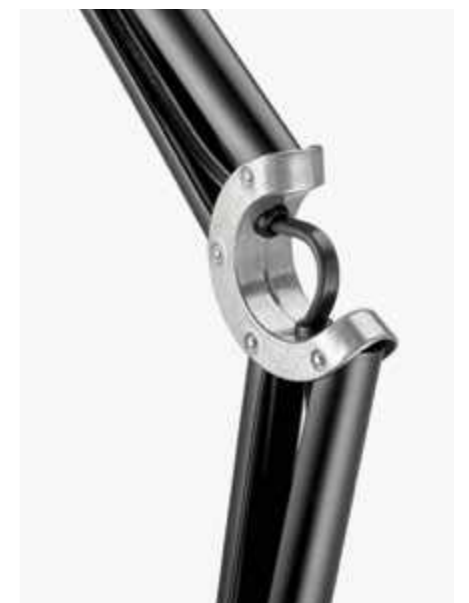



TECHNICAL DETAILS

NAOMI TAVOLO

Code: 300 + 310 (base)

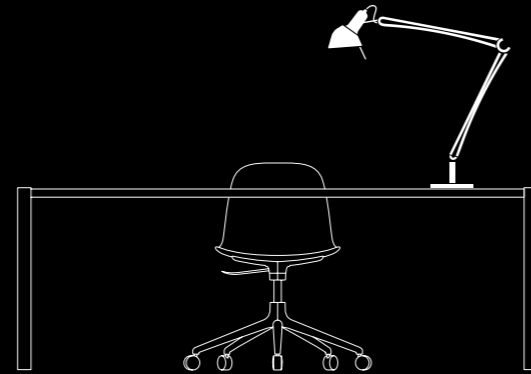

DIMENSIONS

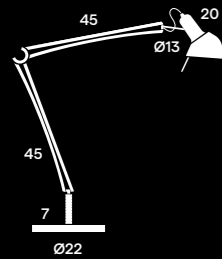

ACTIONS

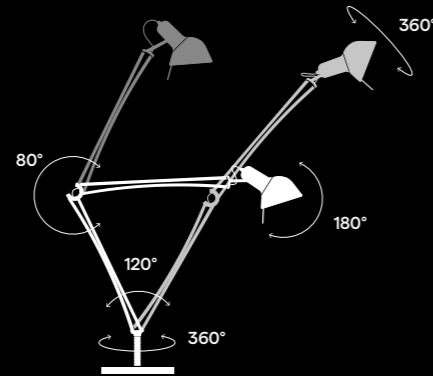

FINISHING

- Black soft-touch
- Anodised aluminium

HALOGEN SOURCE

Power: MAX 75W HAL [E27/E26]

TECHNICAL DATA



LED bulbs compatible
On/Off switch
Bulb (8W LED/E27 2700K) included
Energy class A++ compatible
Insulation Class II
CE Listed



TECHNICAL DETAILS

NAOMI TERRA

Code: 305 + 310 (base)

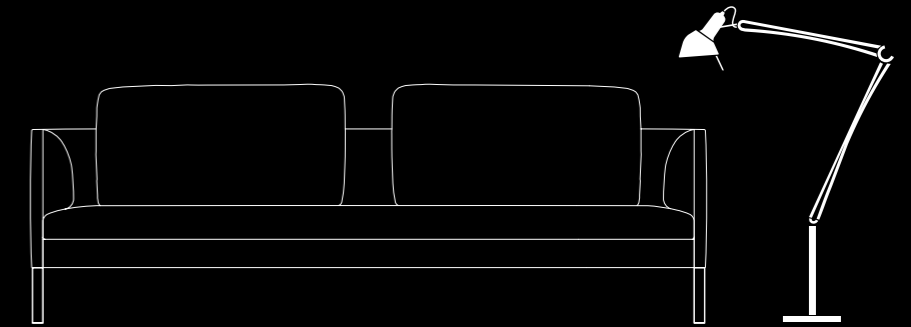

DIMENSIONS

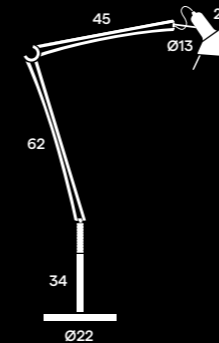

ACTIONS

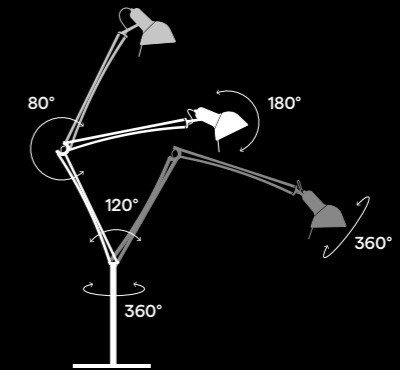

FINISHING

- Black soft-touch
- Anodised aluminium

HALOGEN SOURCE

Power: MAX 75W HAL [E27/E26]

TECHNICAL DETAILS

NAOMI MORSETTO

Code: 329



DIMENSIONS

ACTIONS

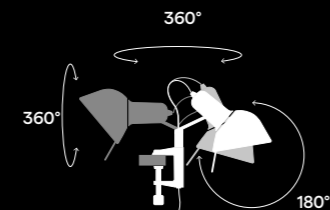
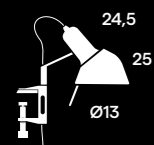

FINISHING

HALOGEN SOURCE

- Black soft-touch
- Anodised aluminium

Power: MAX 75W HAL [E27/E26]

TECHNICAL DATA



LED bulbs compatible
On/Off switch
Bulb (8W LED/E27 2700K) included
Energy class A++ compatible
Insulation Class II
CE Listed



TECHNICAL DETAILS

NAOMI PINZA / PARETE

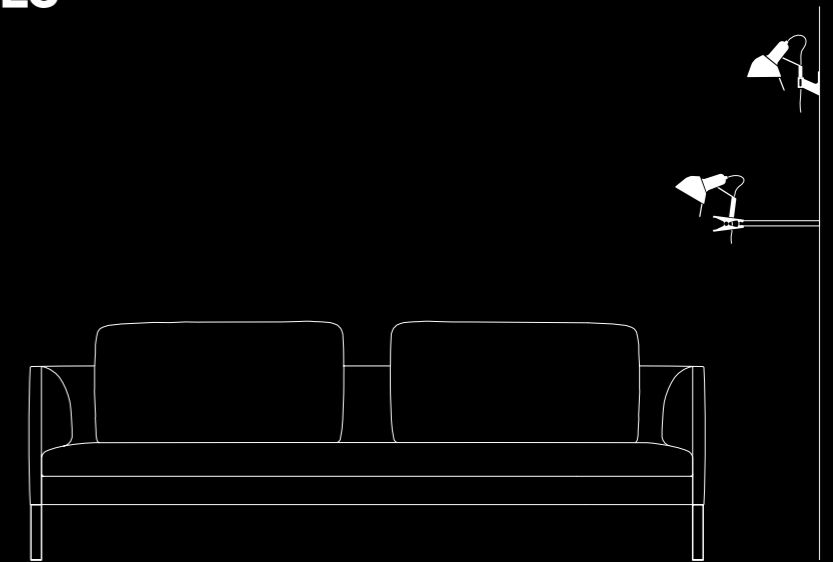

DIMENSIONS

PINZA

Code: 328

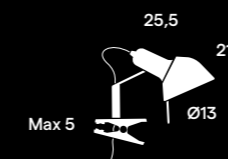

PARETE

Code: 330

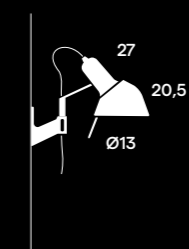

FINISHING

HALOGEN SOURCE

- Black soft-touch
- Anodised aluminium

Power: MAX 75W HAL [E27/E26]

OPUS
/WALTER MONICI

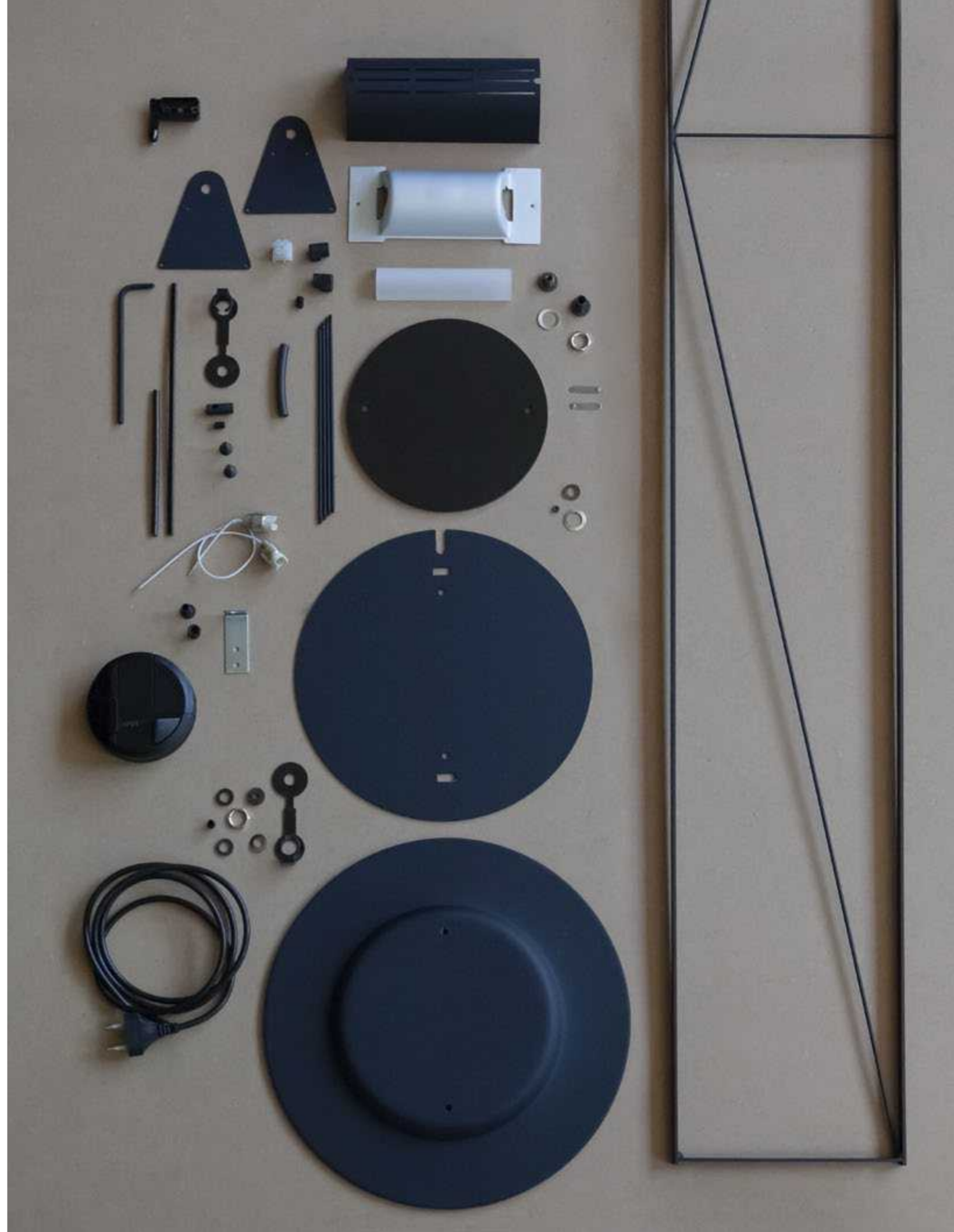

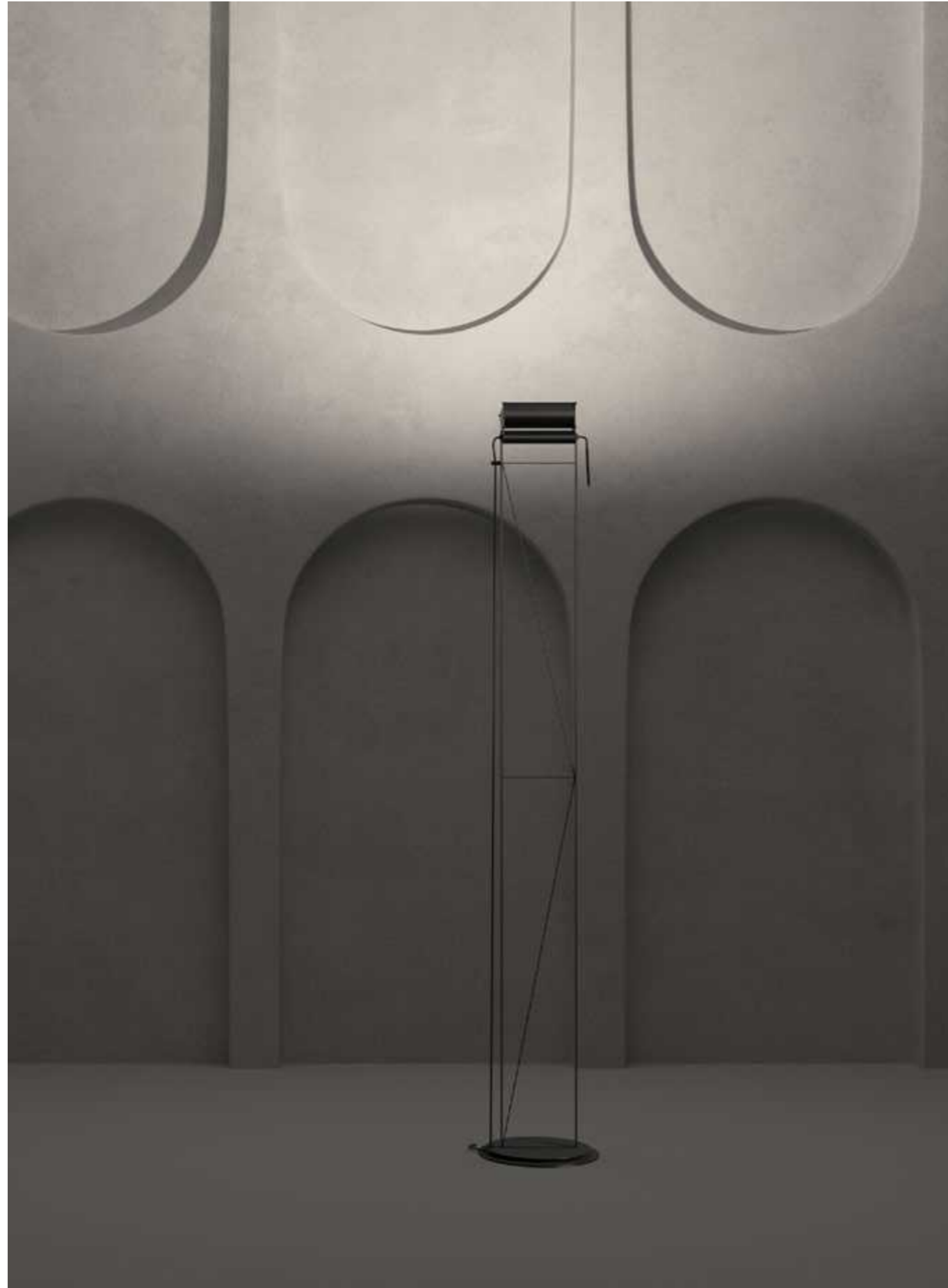

OPUS

The Opus is a floor-standing lamp designed by Walter Monici and made of metal. The thin load-bearing structure carries an indirect light diffuser with a handle to direct it and a dimmer to control the amount of light.

The base is designed in such a way that any excess cable can be neatly wrapped around it.

There is also a highly functional wall-mounting version that provides excellent lighting, the Opus Parete. Given its luminous power, it is often ordered for use in corridors and waiting rooms.





TECHNICAL DETAILS

OPUS TERRA

Code: 70

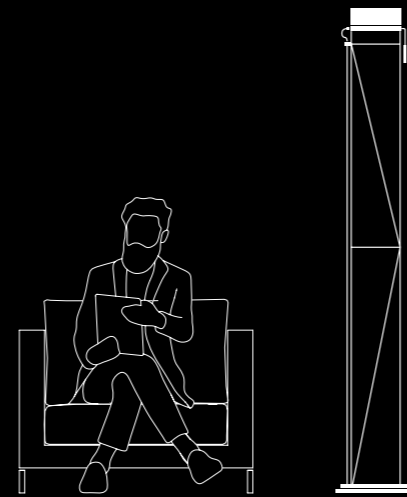

DIMENSIONS

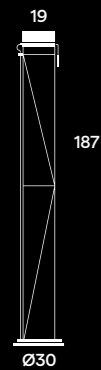

ACTIONS

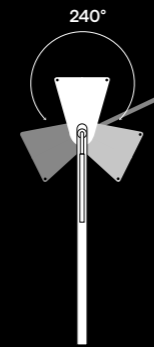

FINISHING

- Black soft-touch
- Matt white

HALOGEN SOURCE

Power: MAX 300W HAL [R7s]

TECHNICAL DATA



Bulb (230V Energy Saver R7s) included
Energy class C
Dimmer
Insulation Class II
CE Listed

TECHNICAL DETAILS

OPUS PARETE

Code: 71

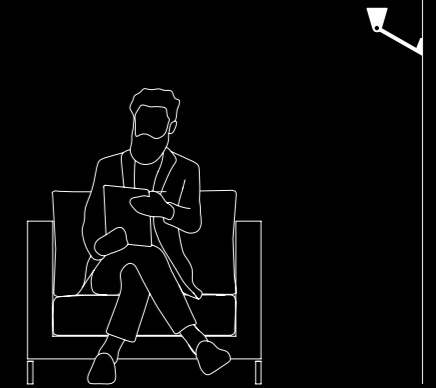

DIMENSIONS

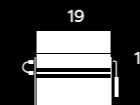

ACTIONS

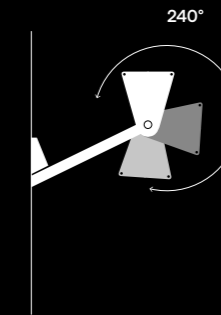

FINISHING

- Black soft-touch
- Matt white

HALOGEN SOURCE

Power: MAX 300W HAL [R7s]

PERLA
/WALTER MONICI





PERLA 35 GARDEN

The meeting of Lumina owner Ettore Cimini and designer Walter Monici gave rise to a whole collection of outdoor lamps: Perla Garden 35.

The Perla is a pendant lamp with a spherical unbreakable polyethylene diffuser (white) supported by a cable structure made of die-cast aluminium. Perla Garden 35's value added is the possibility of connecting a number of spherical diffusers in a cascade system powered by the same outlet.

Vertical and horizontal adjustment of the luminaires is provided by cords and cables and other easy to use accessories.

The resulting composite system is ideal for stylish lighting of outdoor spaces, from gardens to terraces, where it creates a sophisticated and romantic atmosphere.

The system for fixing the cables to the sphere was designed, engineered and patented by Lumina.



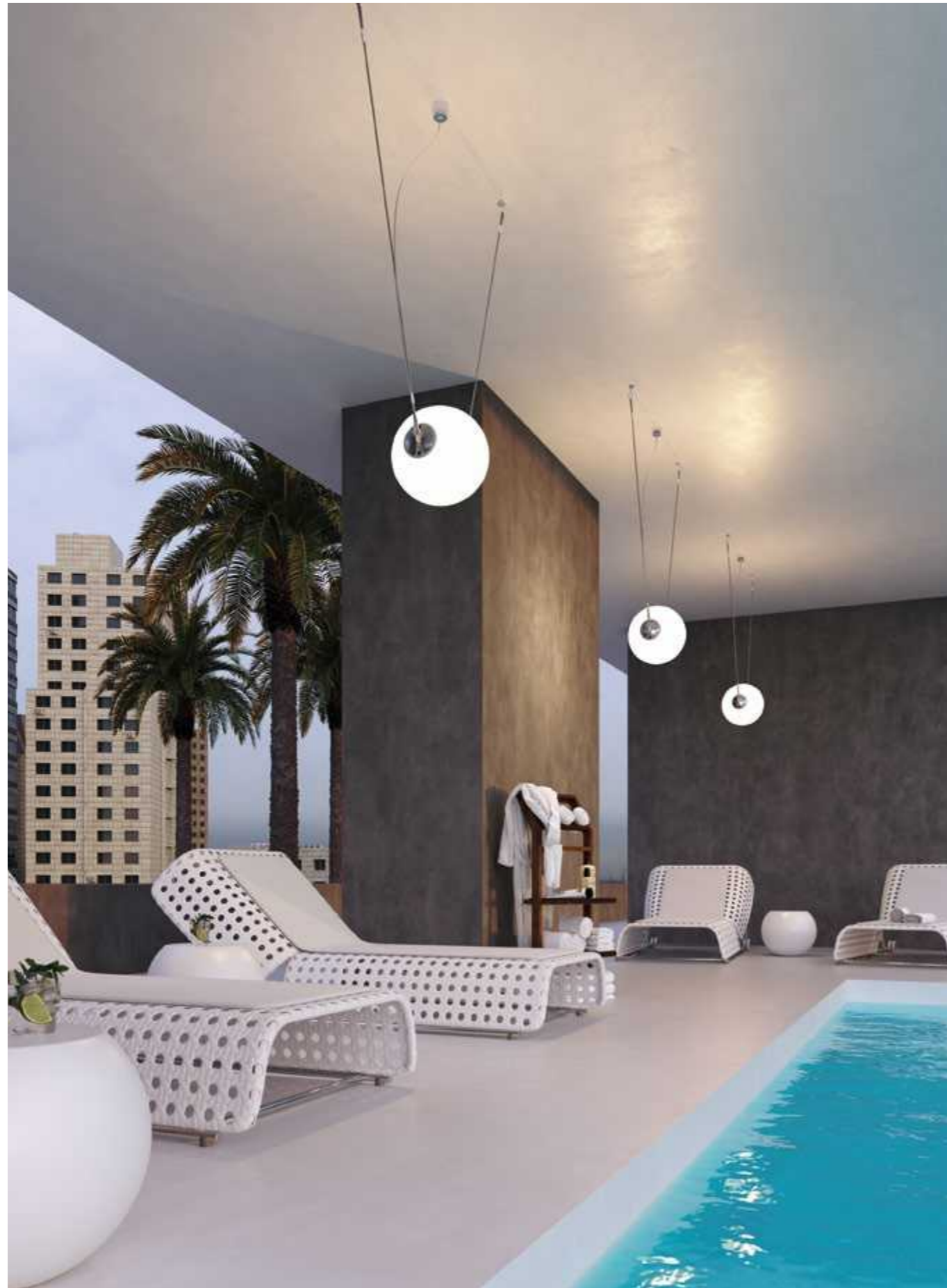

TECHNICAL DETAILS

PERLA 35 GARDEN

Code: 860

DIMENSIONS

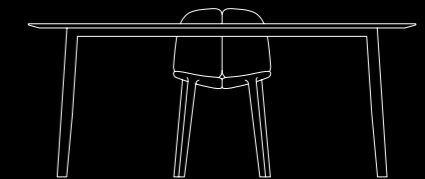
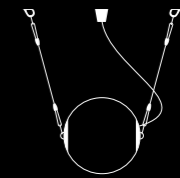
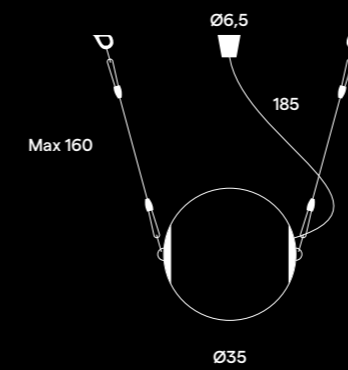

FINISHING

● Polished aluminum - unbreakable polyethylene

HALOGEN SOURCE

Power: MAX 150W HAL [E27/E26]

TECHNICAL DATA



LED bulbs compatible
 Dimmable (according to installed bulbs)
 Bulbs not included
 Energy class A++ compatible
 Insulation Class I
 CE Listed

TANGRAM
/WALTER MONICI





TANGRAM

Free to move, rotate and swivel in the air with elegance, Tangram lamps are ideal for lighting prestige workstations and sophisticated reading corners.

The table and floor versions (designed by Walter Monici) have a thin but solid aluminium and metal structure and a reflector that can be pointed in all directions. The lamp's value added lies in the extreme mobility of its jointed arm, which can turn through 360°.

In this way the Tangram can reach any point that needs lighting.





TECHNICAL DETAILS

TANGRAM TAVOLO

Code: 101 + 114 (base)

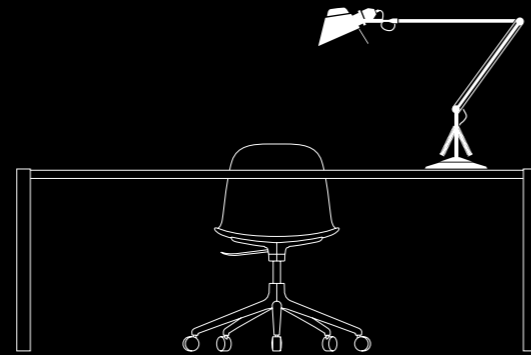

DIMENSIONS

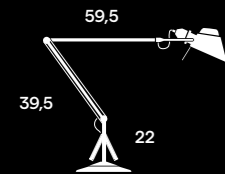

ACTIONS

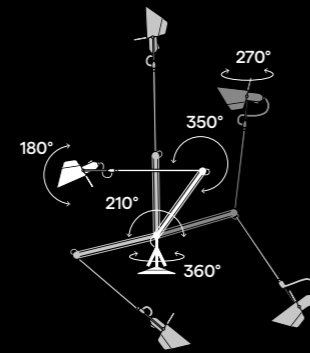

FINISHING

- Black soft-touch
- Anodised aluminium
- Brushed nickel

HALOGEN SOURCE

Power: MAX 2x75W HAL [E27/E26]

TECHNICAL DATA



LED bulbs compatible
Dimmable (according to installed bulbs)
Bulbs not included
Energy class A++ compatible
Insulation Class I
CE Listed



TANGRAM TERRA

Code: 101 + 125 (base)

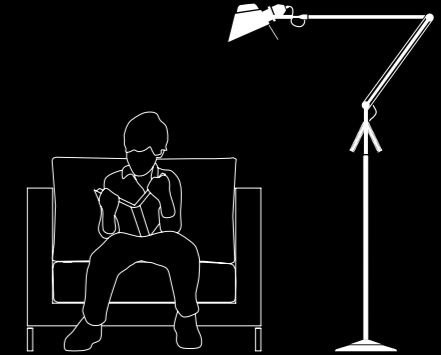

DIMENSIONS

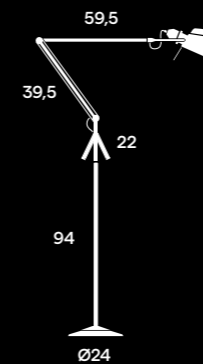

ACTIONS

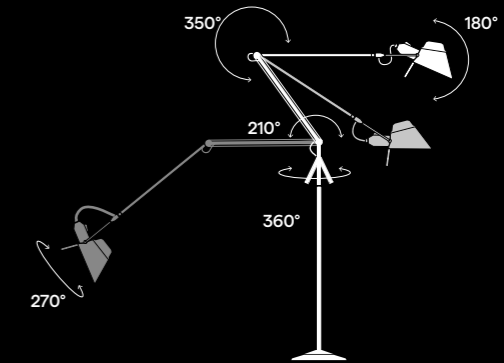

FINISHING

- Black soft-touch
- Anodised aluminium
- Brushed nickel

HALOGEN SOURCE

Power: MAX 75W HAL [E27/E26]

TECHNICAL DATA



LED bulbs compatible
On/Off switch
Bulb (8W LED/E27 2700K) included
Energy class A++ compatible
Insulation Class II
CE Listed

