

LIGHT AT THE HIGHEST LEVEL



**2025/26**

---

**PROJECTS**

# OVERVIEW

## ANBAULEUCHTEN | SURFACE MOUNTED LUMINAIRES | LUMINAIRES EN SAILLIE



LINE40  
**112**



LINE50  
**114**



LINE50hex  
**116**



LINE50HEXmute  
**118**



LINE50quad  
**120**



LINE50QUADmute  
**122**



LINE50splash  
**124**



officeLINE50  
**126**



LINE70  
**128**



RING50  
**130**



RING50mute  
**132**



FLEX50  
**134**



OVOID50  
**136**



ROUND90  
**138**



SQUARE90  
**140**



**142**

## HÄNGELEUCHTEN | PENDANT LUMINAIRES | SUSPENSIONS



LINE40  
**146**



LINE50  
**148**



LINE50hex  
**150**



LINE50HEXmute  
**152**



LINE50quad  
**154**



LINE50QUADmute  
**156**



LINE50splash  
**158**



officeLINE50  
**160**



officeLINE50  
**162**



LINE70  
**164**



RING50  
**166**



RING50mute  
**168**



FLEX50  
**170**



OVOID50  
**172**



ROUND90  
**174**



SQUARE90  
**176**



ROPE22  
**178**

## WANDLEUCHTEN | WALL LUMINAIRES | APPLIQUES MURALES



LINE40  
**182**



LINE50  
**184**



LINE70  
**186**



ROUND90  
**188**



SQUARE90  
**190**

**EINBAULEUCHTEN | RECESSED LUMINAIRES | LUMINAIRES ENCASTRABLES**

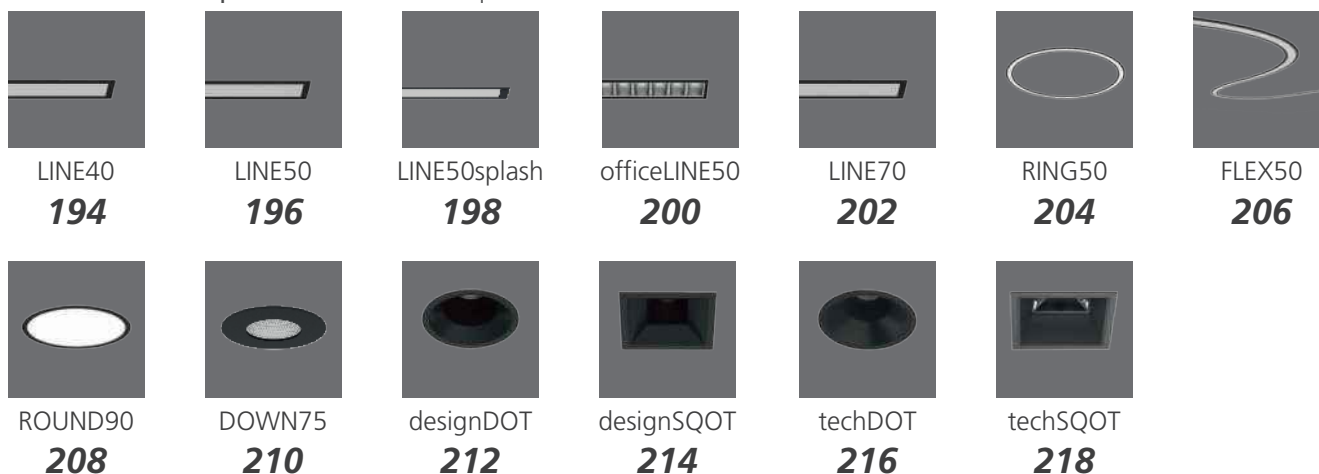

**STEH- UND TISCHKLEMMLEUCHTEN | FREE-STANDING AND DESK-MOUNTED LUMINAIRE | LAMPADAIRE, MONTAGE SUR TABLE**



officeLINE50free 222    officeLINE50free 224

**SCHIENENSTRAHLER | TRACK SPOTLIGHTS | PROJECTEURS SUR RAIL**



GLOWmini 228    GLOWsmall 230    GLOWmedium 232    GLOWlarge 234    GLOWultra 236    GLOWgu10 238



trackS 240    trackM 242    LINE50 244    officeLINE50 246

**LINE48V | LINE48V | LINE48V**



TRACKS 248    LUMINAIRES 276    DRIVERS 300

# LINE40

## HIGH EFFICIENCY

The high luminous output at low power provides an energy efficient luminaire – up to 142 lm/W.

## 4 MOUNTING VERSIONS

The luminaire is available as surface, pendant, recessed or wall luminaire.

## MAKE YOUR WISH COME TRUE

An including sensor, emergency light or many other options are available on demand.

## INDIVIDUAL SHAPES

Due to a modular system, we can make a special form for your desire.

## LIGHT WHERE YOU WANT IT

The luminaire is available either with direct light only or also with additional indirect light.

## SMALL SIZE

The direct luminaire has a height of 62mm – 10mm less than the direct + indirect profile.

## DIFFERENT COLOURS

The housing is available in RAL 9005 black, RAL 9006 silver and RAL 9016 white – RAL of your choice on demand.

## DYNAMIC WHITE

Besides the unicoloured colour temperatures, dynamic white (2700K-6500K) is also available.

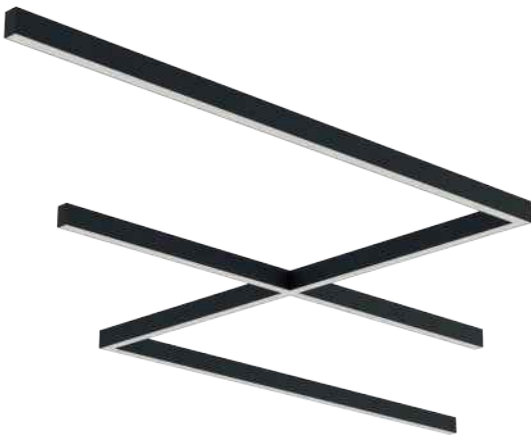

## 3 DIFFERENT DIRECT COVERS

- Opal flat
- Microprism flat
- Opal U-shaped

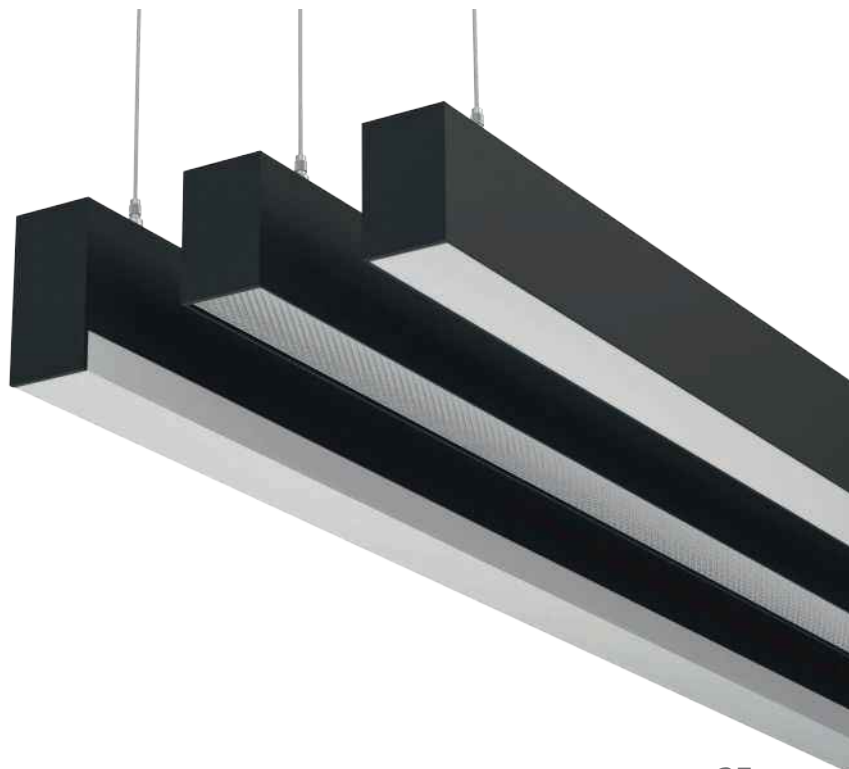



# LINE40

ÜBERSICHT | OVERVIEW | VUE D'ENSEMBLE

## ANBAULEUCHE | SURFACE MOUNTED LUMINAIRE | LUMINAIRE EN SAILLIE

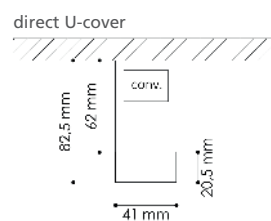
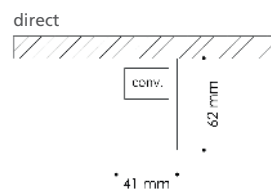
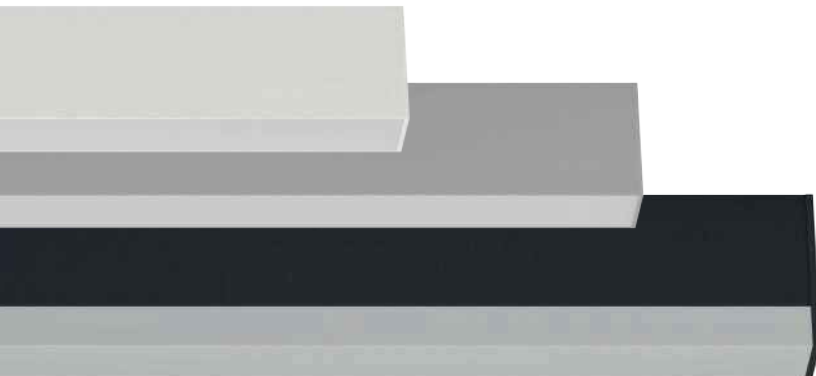

## HÄNGELEUCHE | PENDANT LUMINAIRE | SUSPENSION

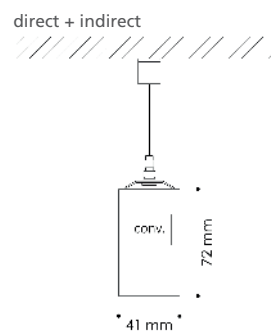
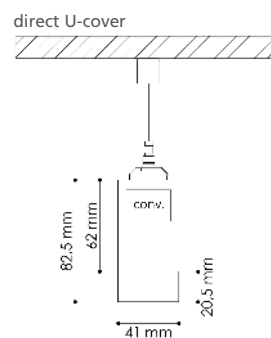
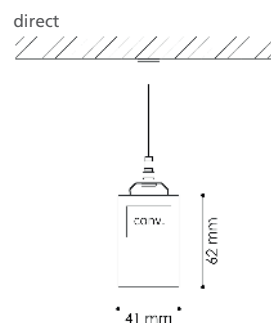

# LINE40

ÜBERSICHT | OVERVIEW | VUE D'ENSEMBLE

WANDLEUCHE | WALL LUMINAIRE | APPLIQUE MURALE



direct

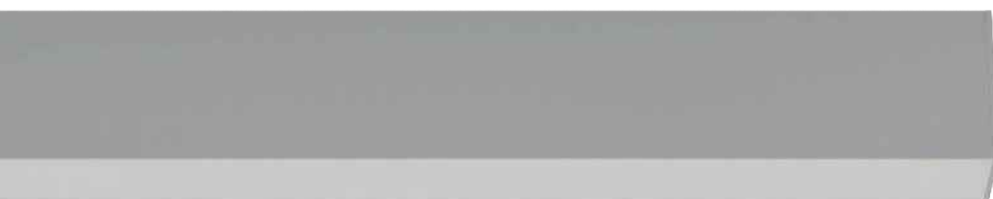
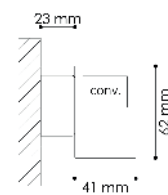

direct + indirect

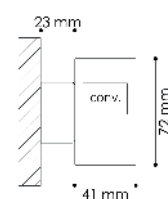

EINBAULEUCHE | RECESSED LUMINAIRE | LUMINAIRE ENCASTRABLE

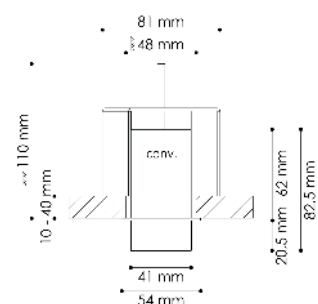
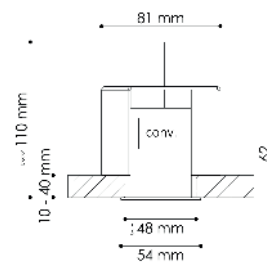



# LINE50

## HIGH EFFICIENCY

The high luminous output at low power provides an energy efficient luminaire – up to 149 lm/W.

## 4 MOUNTING VERSIONS

The luminaire is available as surface, pendant, recessed or wall luminaire.

## DYNAMIC WHITE

Besides the unicoloured colour temperatures, dynamic white (2700K–6500K) is also available.

## MAKE YOUR WISH COME TRUE

An including sensor, emergency light or many other options are available on demand.

## INDIVIDUAL SHAPES

Due to a modular system, we can make a special form for your desire.

## LIGHT WHERE YOU WANT IT

The luminaire is available either with direct light only or also with additional indirect light.

## NOT ONLY SYMMETRICAL

An asymmetrical light distribution is possible thanks to a special foil.

## DIFFERENT COLOURS

The housing is available in RAL 9005 black, RAL 9006 silver and RAL 9016 white – RAL of your choice on demand.

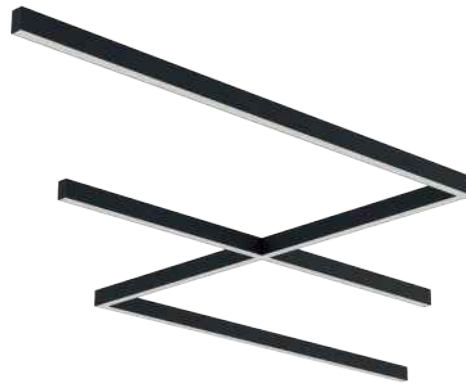

## LINE50hex

LINE50 as hexagon or square shape with welded corners in 3 sizes each are already included in the standard portfolio.



## LINE50quad



# LINE50

ÜBERSICHT | OVERVIEW | VUE D'ENSEMBLE

ANBAULEUCHE | SURFACE MOUNTED LUMINAIRE | LUMINAIRE EN SAILLIE

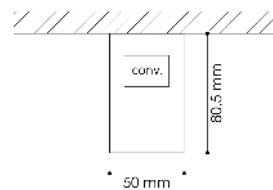

HÄNGELEUCHE | PENDANT LUMINAIRE | SUSPENSION

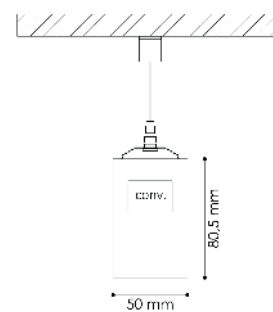
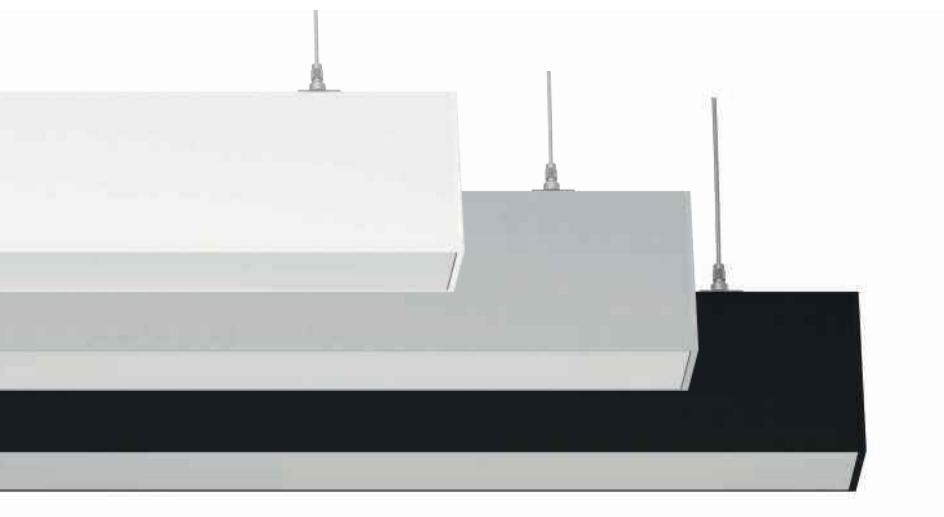

# LINE50

ÜBERSICHT | OVERVIEW | VUE D'ENSEMBLE

WANDLEUCHE | WALL LUMINAIRE | APPLIQUE MURALE

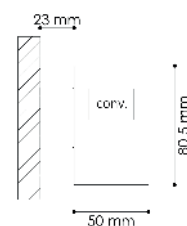
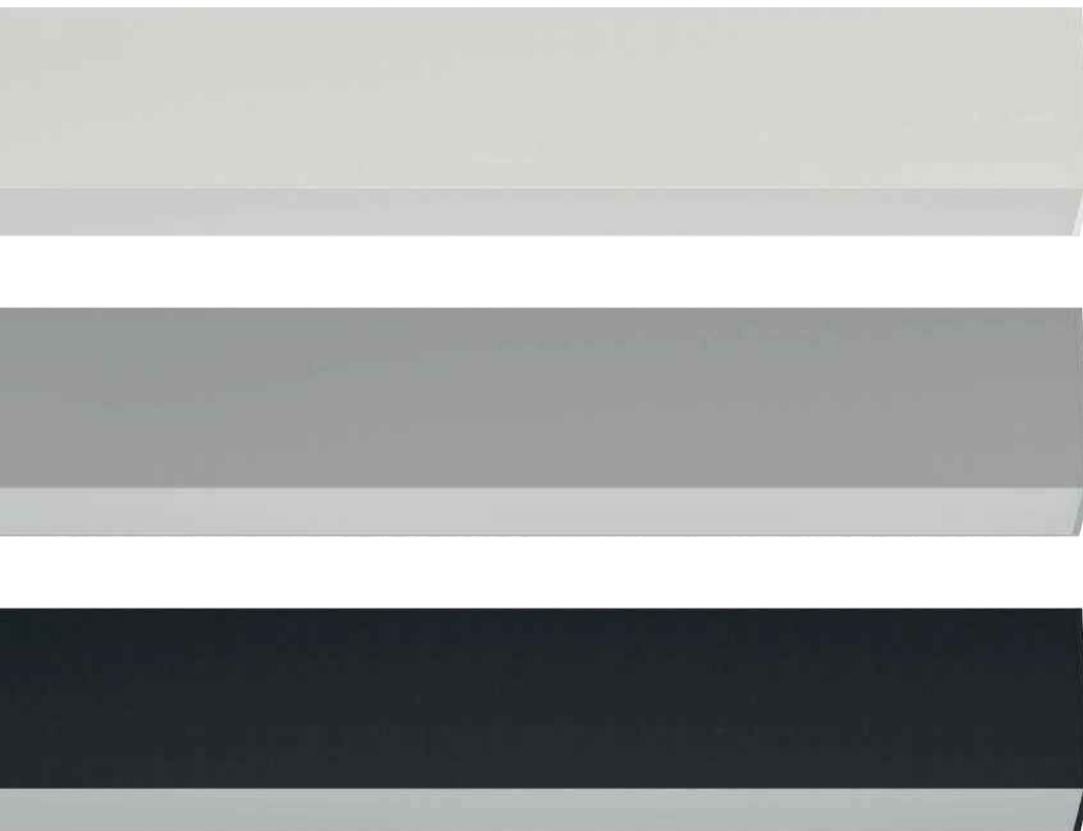

EINBAULEUCHE | RECESSED LUMINAIRE | LUMINAIRE ENCASTRABLE

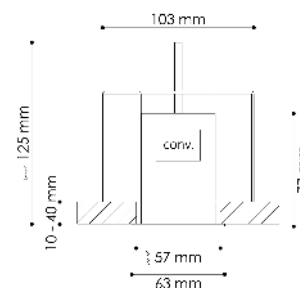
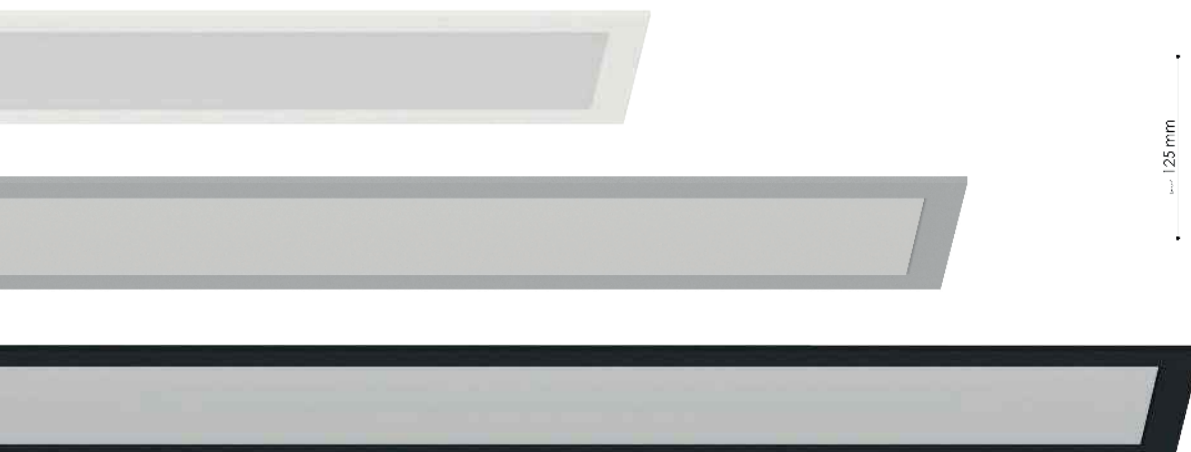

# LINE50hex

ÜBERSICHT | OVERVIEW | VUE D'ENSEMBLE

ANBAULEUCHE | SURFACE MOUNTED LUMINAIRE | LUMINAIRE EN SAILLIE

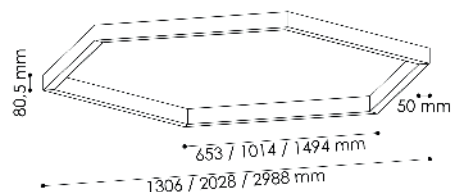
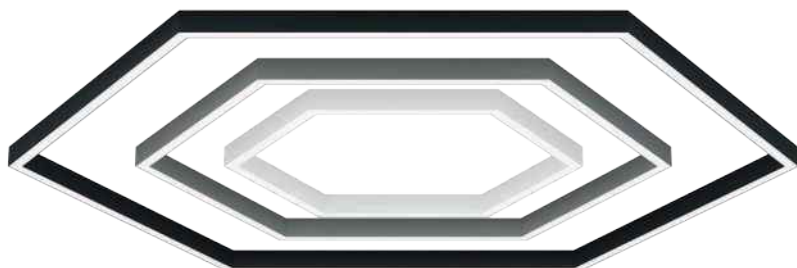

HÄNGELEUCHE | PENDANT LUMINAIRE | SUSPENSION

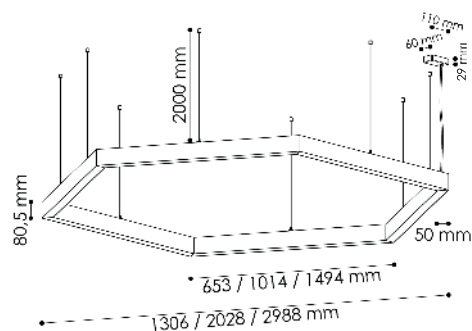







# LINE50quad

ÜBERSICHT | OVERVIEW | VUE D'ENSEMBLE

ANBAULEUCHTE | SURFACE MOUNTED LUMINAIRE | LUMINAIRE EN SAILLIE

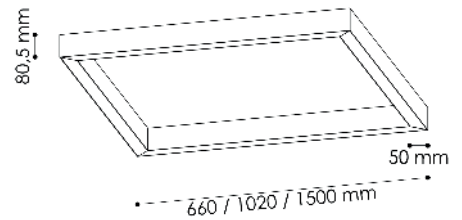

HÄNGELEUCHE | PENDANT LUMINAIRE | SUSPENSION

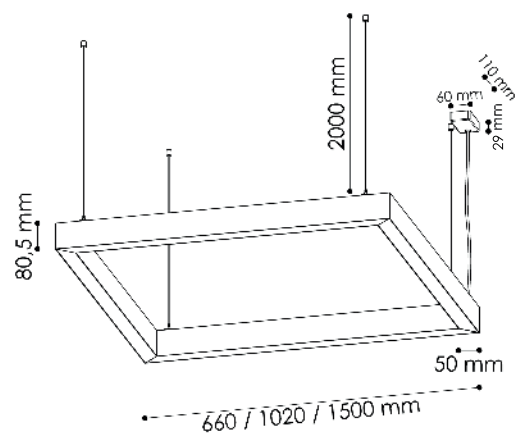

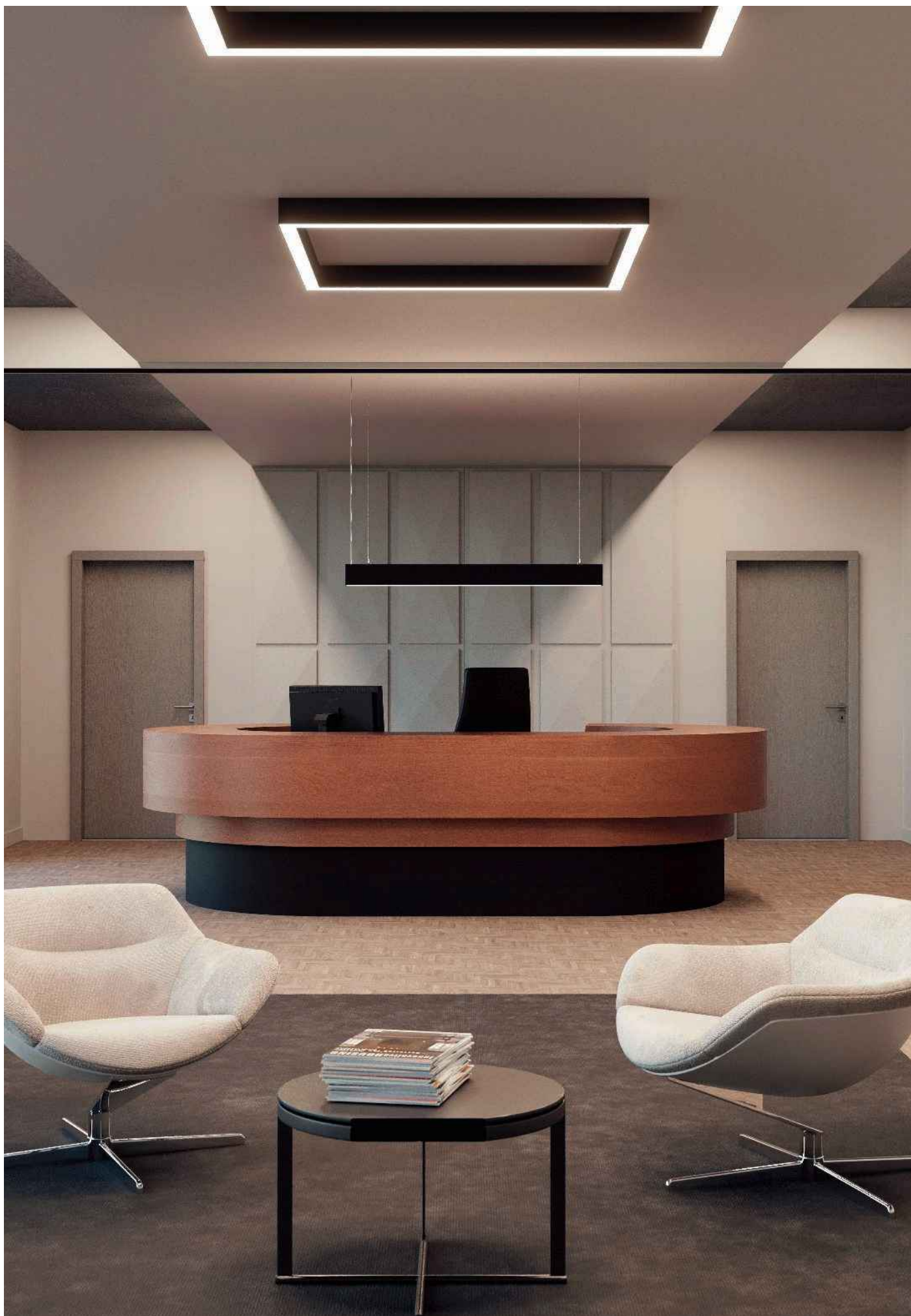

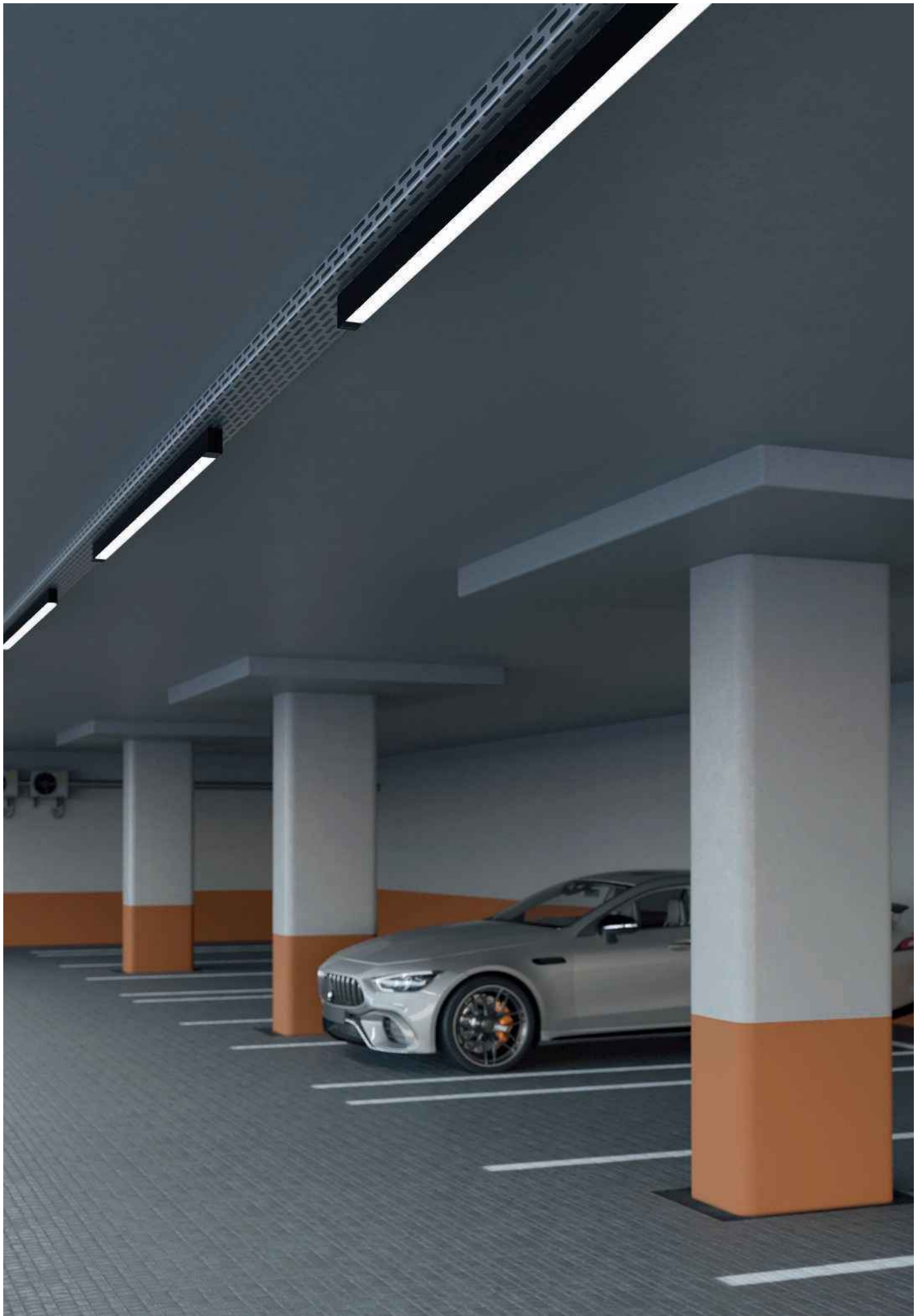

# LINE50splash

## HIGH EFFICIENCY

The high luminous output at low power provides an energy efficient luminaire – up to 130 lm/W.

## 3 MOUNTING VERSIONS

The luminaire is available as surface-mounted, recessed or pendant luminaire.

## DIFFERENT COLOURS

The housing is available in RAL 9005 black, RAL 9006 silver and RAL 9016 white – RAL of your choice on demand.

## INCREASED PROTECTION TYPE

Our profile in IP54 rated luminaires offer reliable protection against moisture, splash water, dust and dirt particles.

## DYNAMIC WHITE

Besides the unicoloured colour temperatures dynamic white (2700K-6500K) is also available.

## MAKE YOUR WISHES COME TRUE

An including emergency light or many other options are available on demand.



# LINE50splash

ÜBERSICHT | OVERVIEW | VUE D'ENSEMBLE

ANBAULEUCHE | SURFACE MOUNTED LUMINAIRE | LUMINAIRE EN SAILLIE

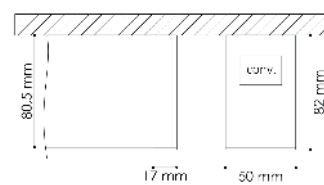

HÄNGELEUCHE | PENDANT LUMINAIRE | SUSPENSION

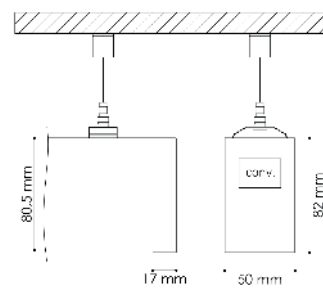
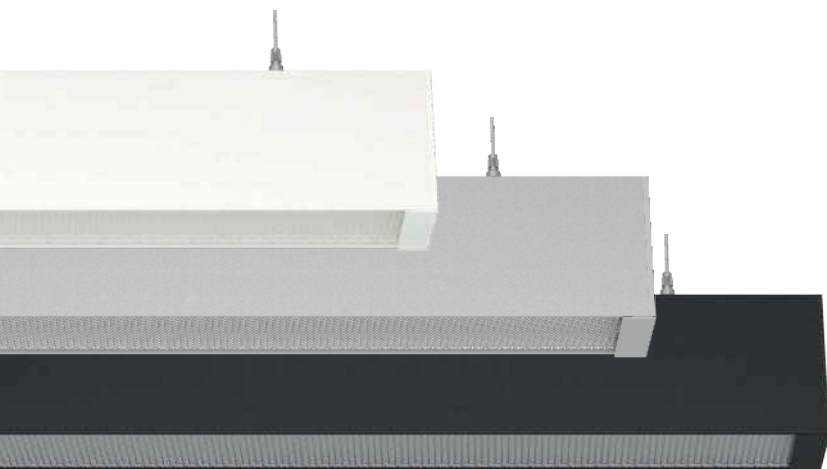

# LINE50splash

ÜBERSICHT | OVERVIEW | VUE D'ENSEMBLE

EINBAULEUCHE | RECESSED LUMINAIRE | LUMINAIRE ENCASTRABLE

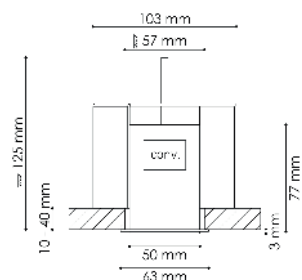





# officeLINE50

## HIGH EFFICIENCY

The high luminous output at low power provides an energy efficient luminaire – up to 162 lm/W.

## 3 MOUNTING VERSIONS

The luminaire is available as surface, pendant or recessed luminaire.

## SENSOR

The 3 most common lengths of the pendant luminaire are also available with a sensor as standard.

## PERFECT FOR YOUR WORK DESK

Special reflectors provide a glare-free light distribution (UGR<19).

## LIGHT WHERE YOU WANT IT

The luminaire is available either with direct light only or also with additional indirect light.

## DYNAMIC WHITE

Besides the unicoloured colour temperatures, dynamic white (2700K–6500K) is also available.

## MAKE YOUR WISH COME TRUE

An including sensor, emergency light or many other options are available on demand.

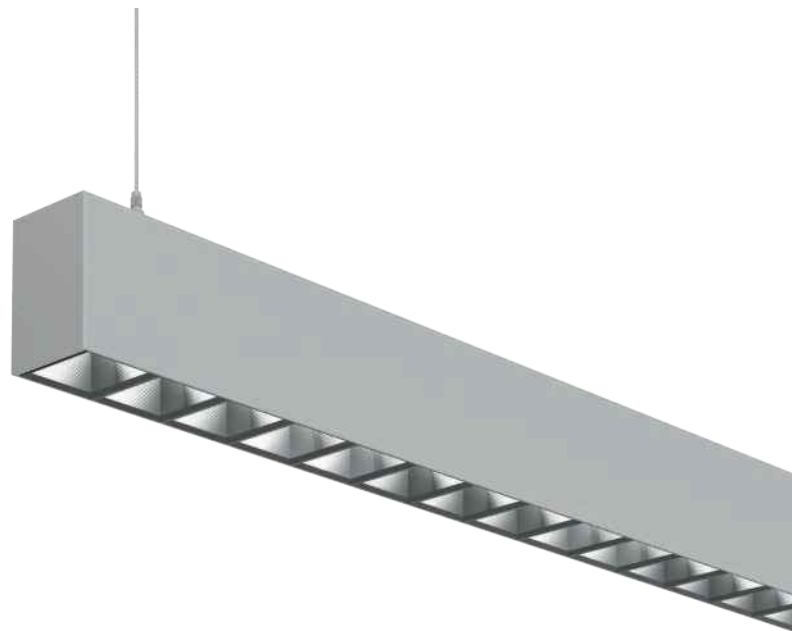

## SOMETHING FOR EVERY TASTE

- 7 different reflector colours and finishes
- 3 different housing colours
- RAL of your choice for the housing on demand





# officeLINE50

ÜBERSICHT | OVERVIEW | VUE D'ENSEMBLE

ANBAULEUCHE | SURFACE MOUNTED LUMINAIRE | LUMINAIRE EN SAILLIE

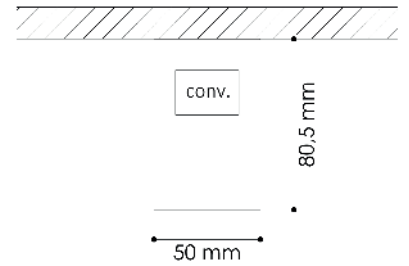
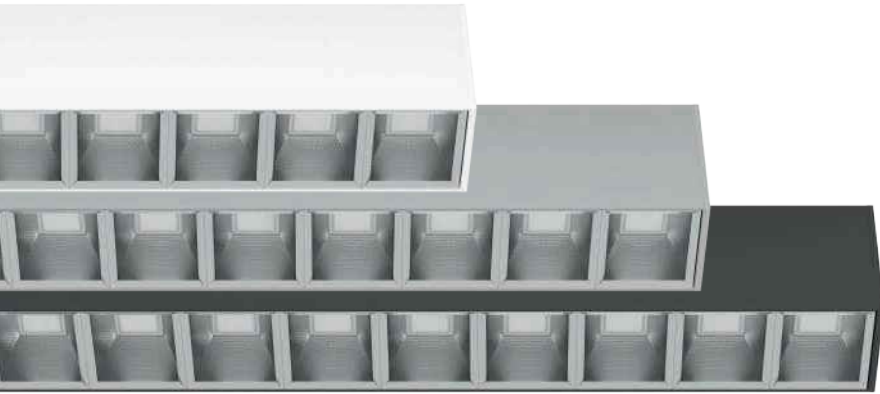

EINBAULEUCHE | RECESSED LUMINAIRE | LUMINAIRE ENCASTRABLE

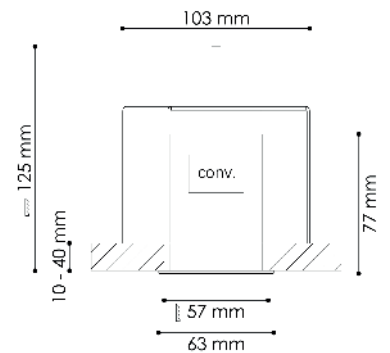
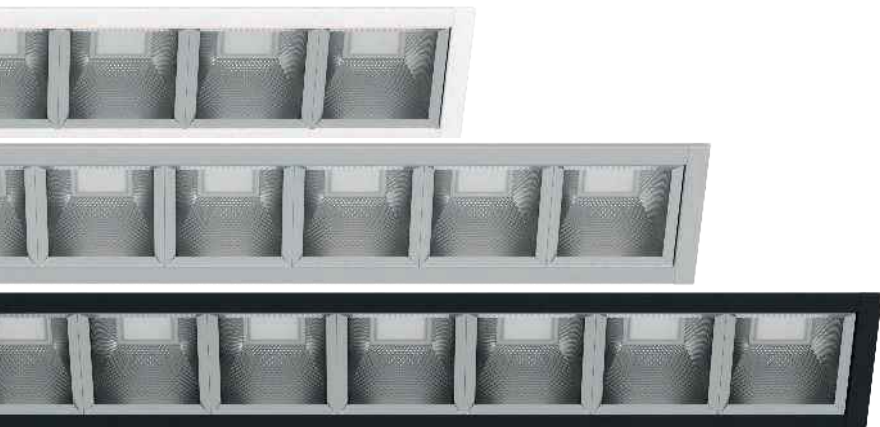

# officeLINE50

ÜBERSICHT | OVERVIEW | VUE D'ENSEMBLE

HÄNGELEUCHTE | PENDANT LUMINAIRE | SUSPENSION

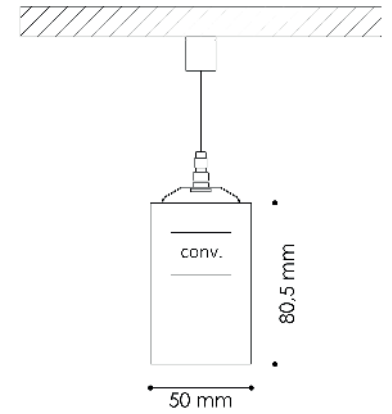
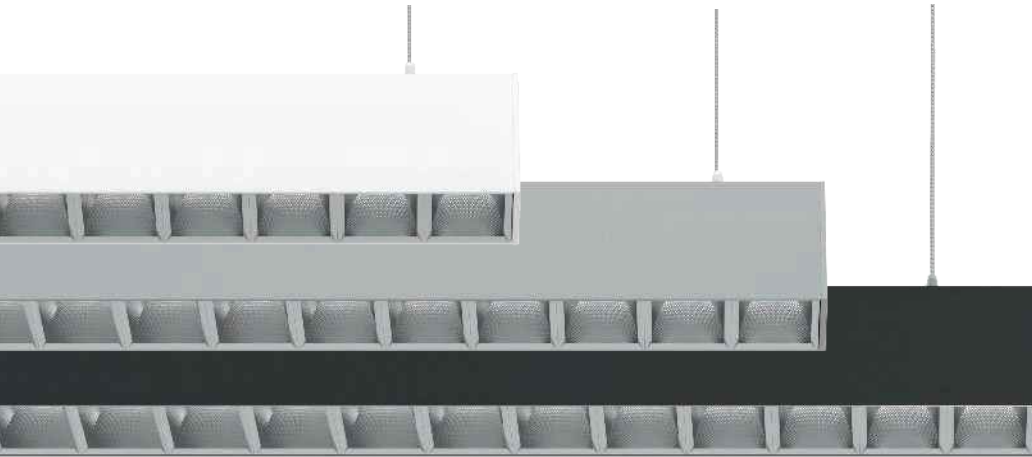

HÄNGELEUCHTE MIT SENSOR | PENDANT LUMINAIRE WITH SENSOR | LUMINAIRE SUSPENDOU AVEC CAPTEUR

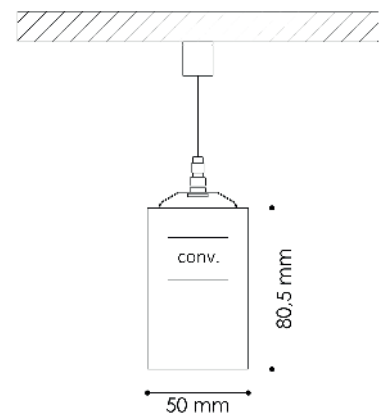



asymmetric  
light distribution

**Light where you need it!**

# officeLINE50free

## HIGH EFFICIENCY

The high luminous output at low power provides an energy efficient luminaire – up to 141 lm/W.

## 2 VERSIONS

The luminaire is available as free-stand or as desk-mounted luminaire.

## WIDE ILLUMINATION

Selectable between a single head version for double workstations or a double head version for quadruple workstations.

## UNICOLOUR VERSION

The luminaire is available either with dimming option via touchpanel only or also with additional moving- and daylight sensor.

## DYNAMIC WHITE

Besides the unicoloured colour temperatures dynamic white (2700K-6500K) is also available.

## PERFECT FOR YOUR WORK DESK

Special reflectors provide a glare-free light distribution (UGR<19).

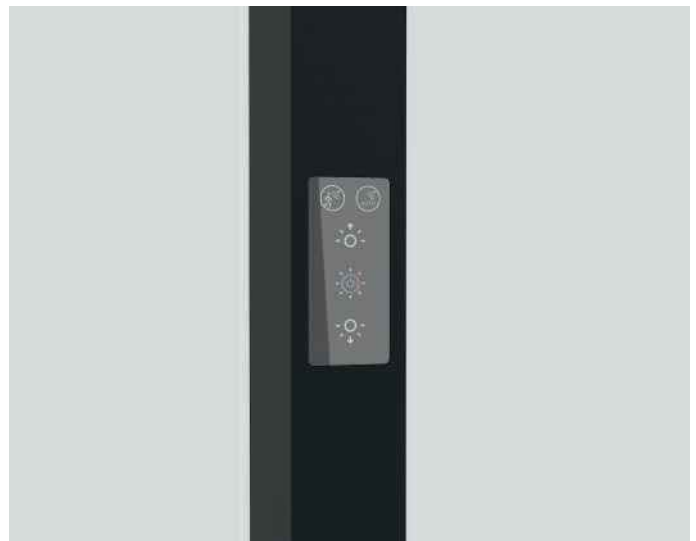

## SOMETHING FOR EVERY TASTE

- 7 different reflector colours and finishes
- 3 different housing colours
- RAL of your choice for the housing on demand



# officeLINE50free

ÜBERSICHT | OVERVIEW | VUE D'ENSEMBLE

STEHLEUCHTE | FREE-STAND | LAMPADAIRE

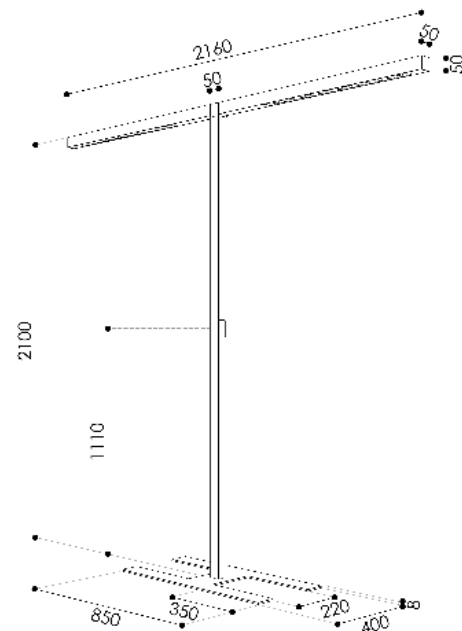
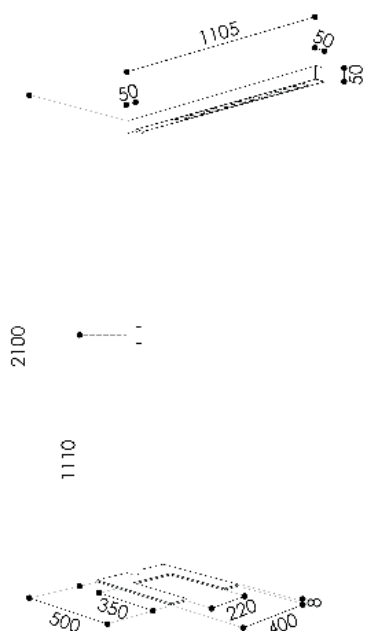
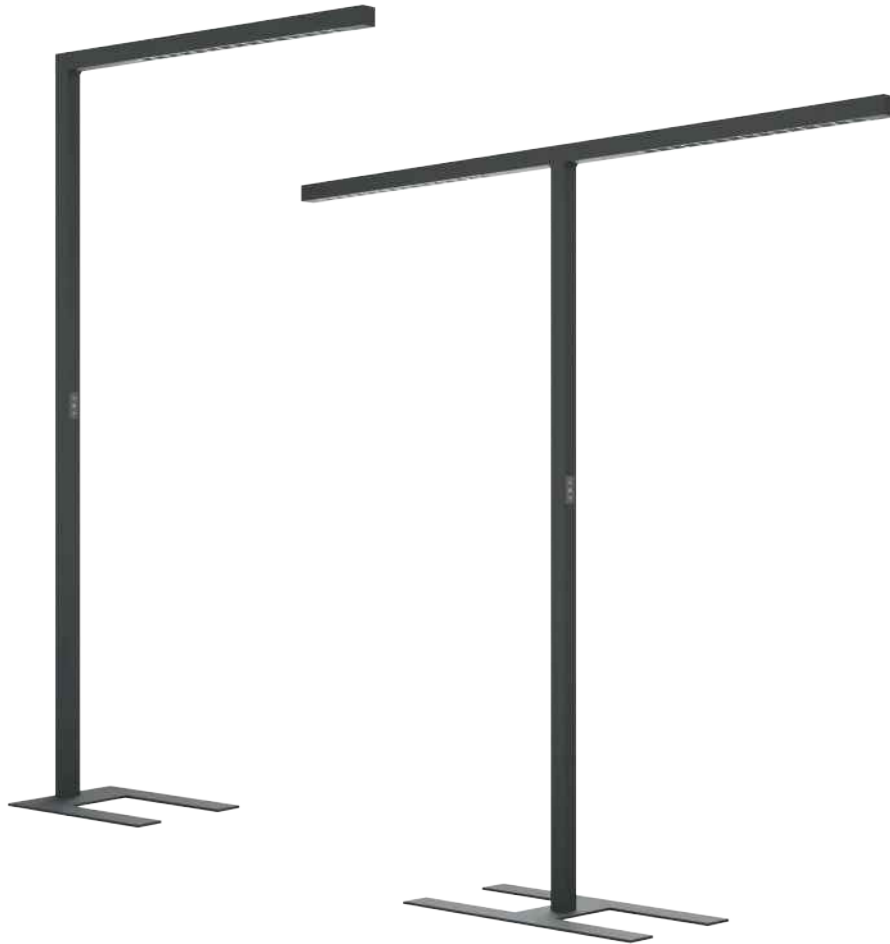

# officeLINE50free

ÜBERSICHT | OVERVIEW | VUE D'ENSEMBLE

TISCHKLEMMLEUCHE | DESK-MOUNTED LUMINAIRE | LUMINAIRE MONTAGE SUR TABLE

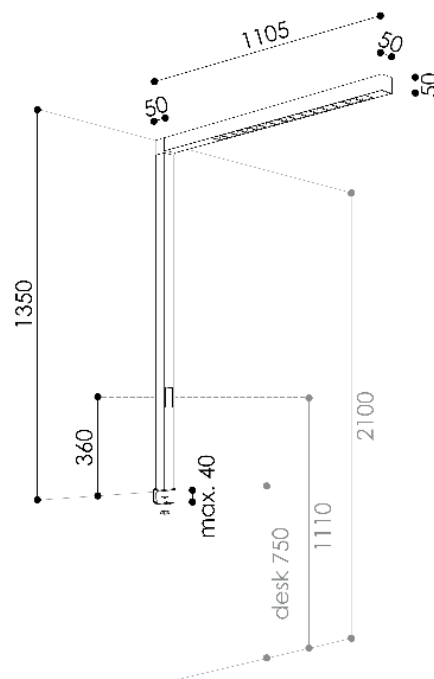

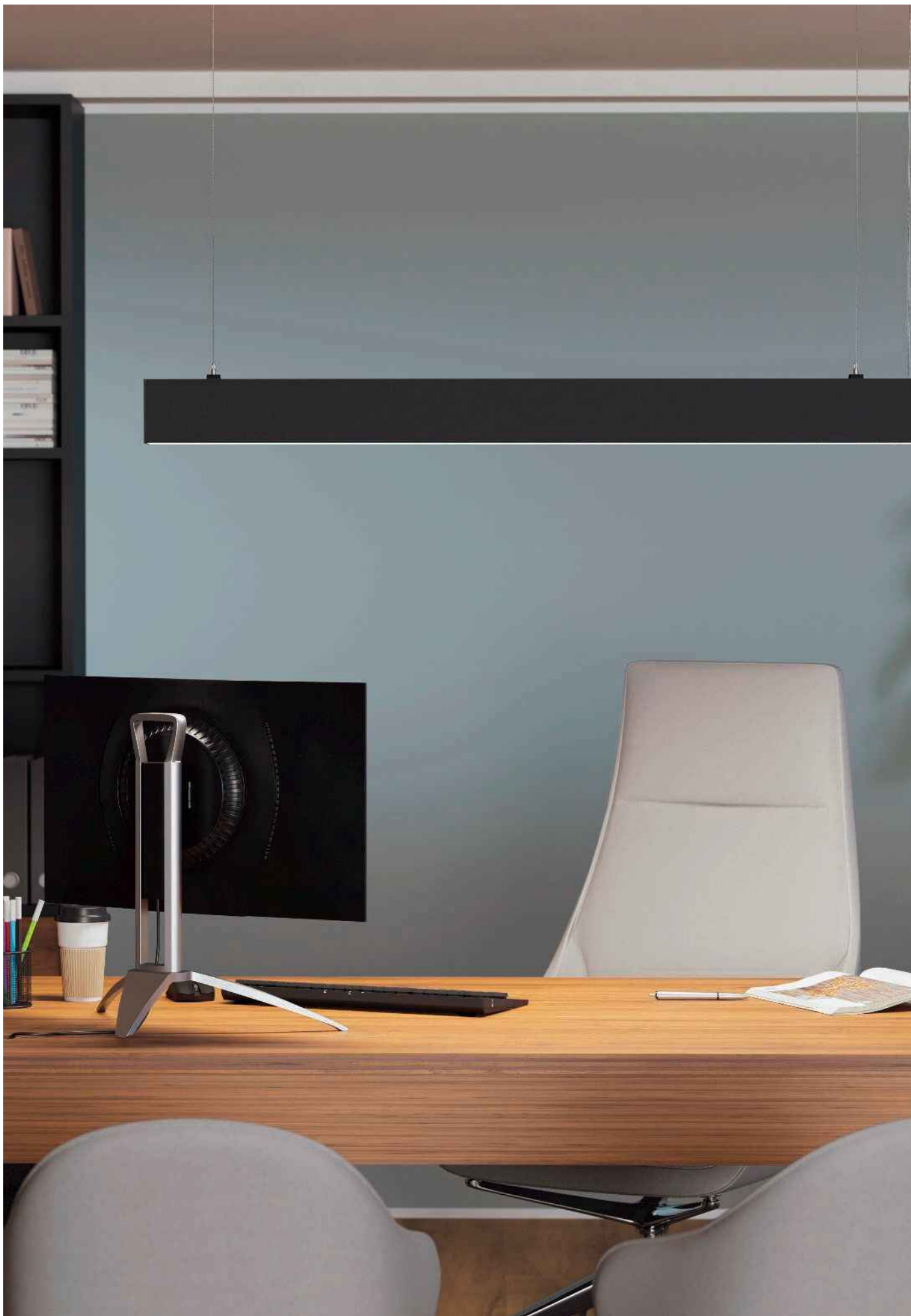

# LINE70

## HIGH EFFICIENCY

The high luminous output at low power provides an energy efficient luminaire – up to 161 lm/W.

## 4 MOUNTING VERSIONS

The luminaire is available as surface, pendant, recessed or wall luminaire.

## DIFFERENT COLOURS

The housing is available in RAL 9005 black, RAL 9006 silver and RAL 9016 white – RAL of your choice on demand.

## INDIVIDUAL SHAPES

Due to a modular system, we can make a special form for your desire.

## LIGHT WHERE YOU WANT IT

The luminaire is available either with direct light only or also with additional indirect light.

## DYNAMIC WHITE

Besides the unicoloured colour temperatures, dynamic white (2700K–6500K) is also available.

## MAKE YOUR WISH COME TRUE

An including sensor, emergency light or many other options are available on demand.

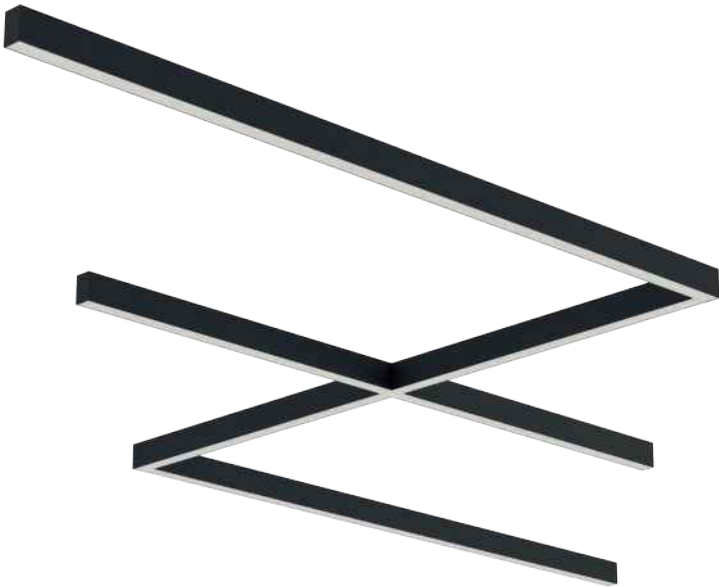



# LINE70

ÜBERSICHT | OVERVIEW | VUE D'ENSEMBLE

ANBAULEUCHE | SURFACE MOUNTED LUMINAIRE | LUMINAIRE EN SAILLIE

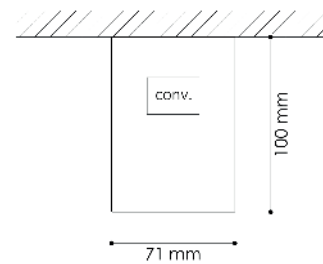
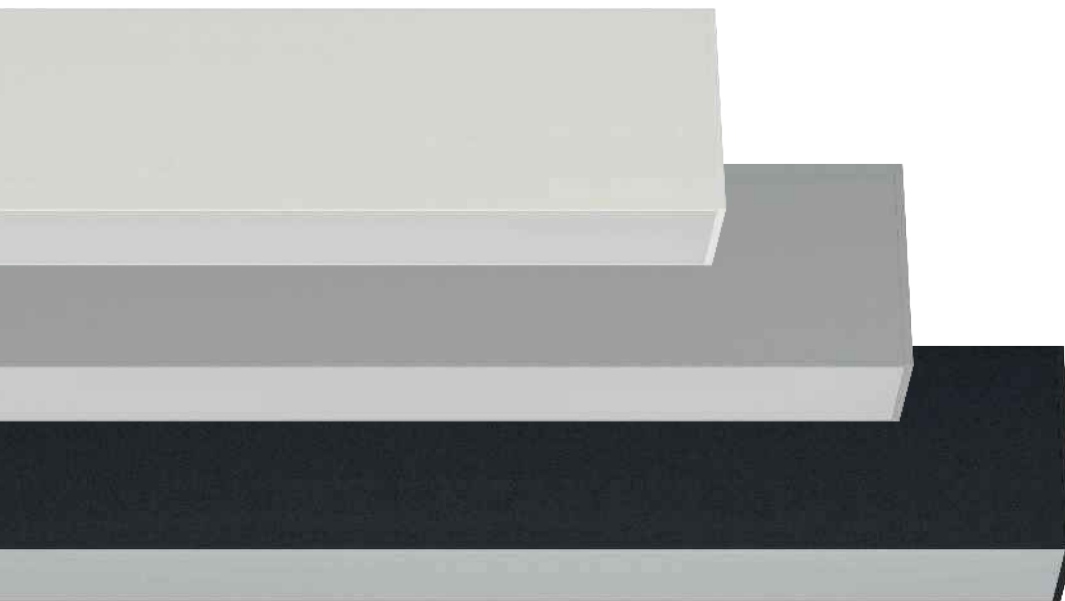

HÄNGELEUCHE | PENDANT LUMINAIRE | SUSPENSION

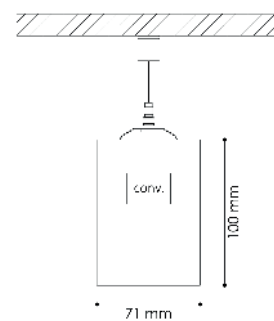

# LINE70

ÜBERSICHT | OVERVIEW | VUE D'ENSEMBLE

WANDLEUCHE | WALL LUMINAIRE | APPLIQUE MURALE

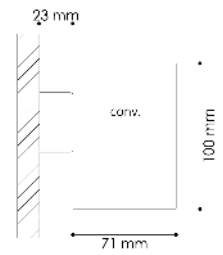
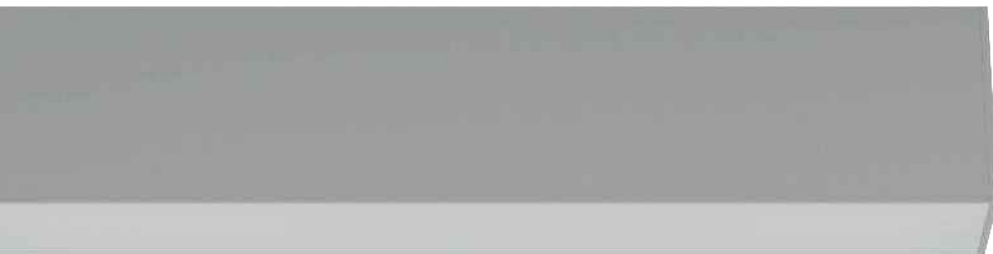

EINBAULEUCHE | RECESSED LUMINAIRE | LUMINAIRE ENCASTRBALE

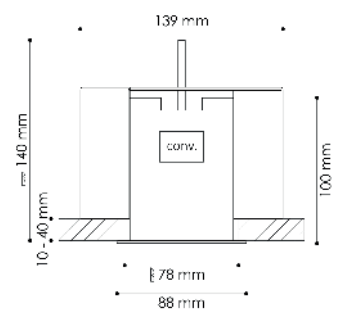

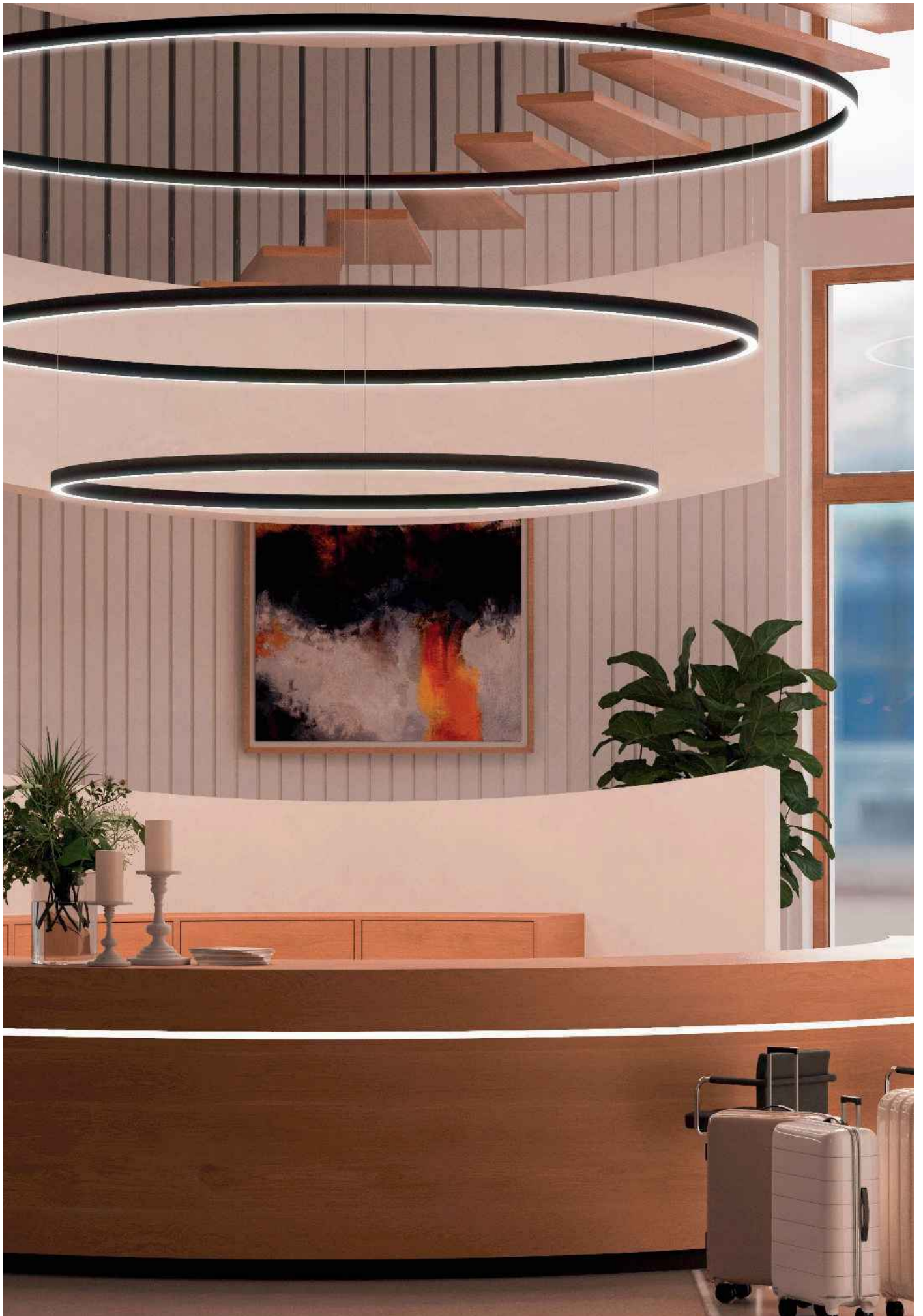

# RING50

## HIGH EFFICIENCY

The high luminous output at low power provides an energy efficient luminaire – up to 136 lm/W.

## 3 MOUNTING VERSIONS

The luminaire is available as surface, pendant or recessed luminaire.

## DIFFERENT COLOURS

The housing is available in RAL 9005 black, RAL 9006 silver and RAL 9016 white – RAL of your choice on demand.

## LARGE SELECTION OF SIZES

The luminaire is available in 9 different diameters.

## LIGHT WHERE YOU WANT IT

The luminaire is available either with direct light only or also with additional indirect light.

## DYNAMIC WHITE

Besides the unicoloured colour temperatures, dynamic white (2700K–6500K) is also available.

## MAKE YOUR WISH COME TRUE

An including emergency light or many other options are available on demand.



# RING50

ÜBERSICHT | OVERVIEW | VUE D'ENSEMBLE

ANBAULEUCHE | SURFACE MOUNTED LUMINAIRE | LUMINAIRE EN SAILLIE

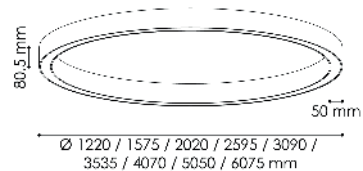

HÄNGELEUCHE | PENDANT LUMINAIRE | SUSPENSION

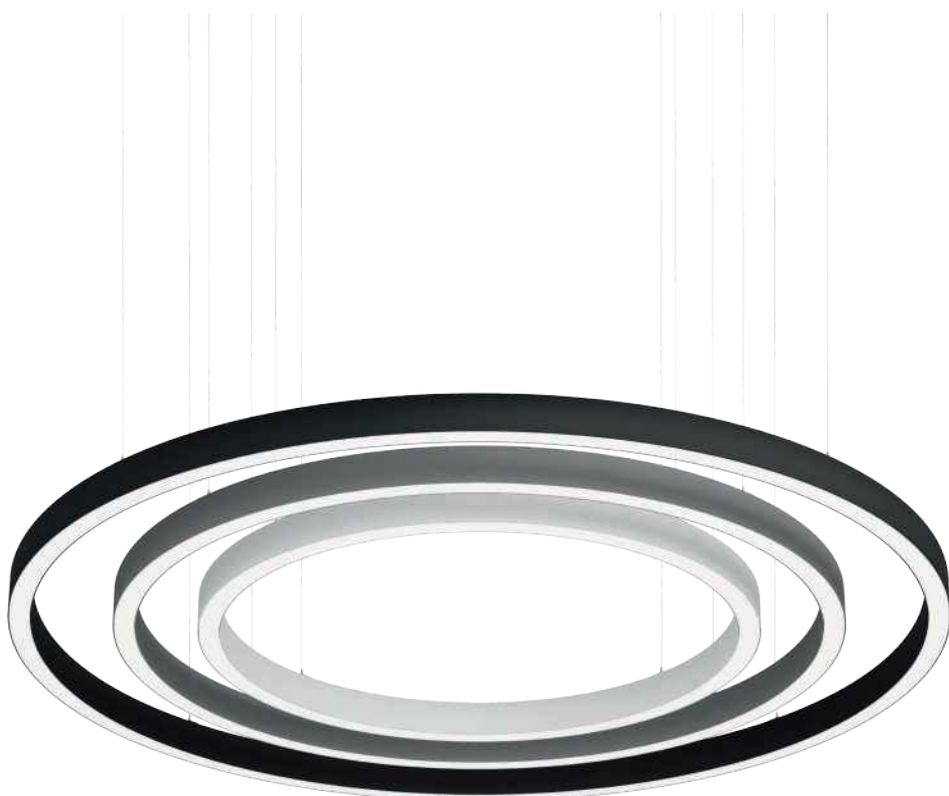

Code Standard: **H**

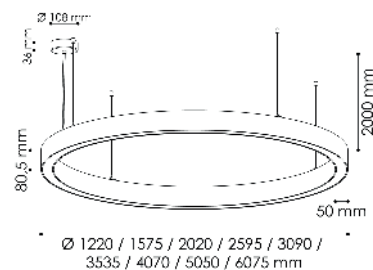

Code Central: **Z**

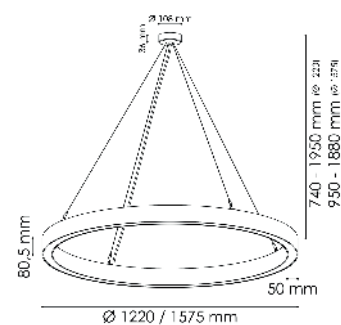

Code Y-Suspension: **Y**

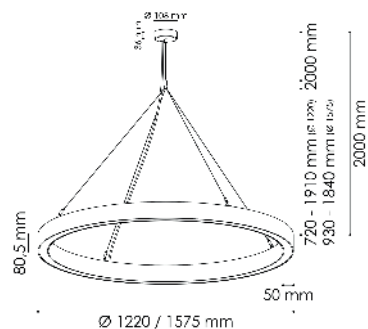

# RING50

ÜBERSICHT | OVERVIEW | VUE D'ENSEMBLE

EINBAULEUCHE | RECESSED LUMINAIRE | LUMINAIRE ENCASTRABLE

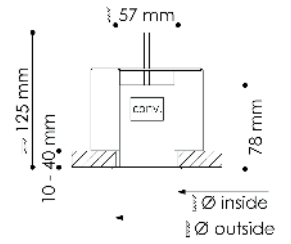
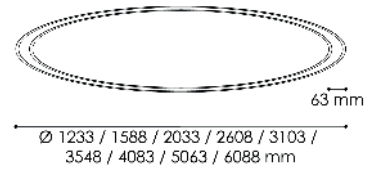
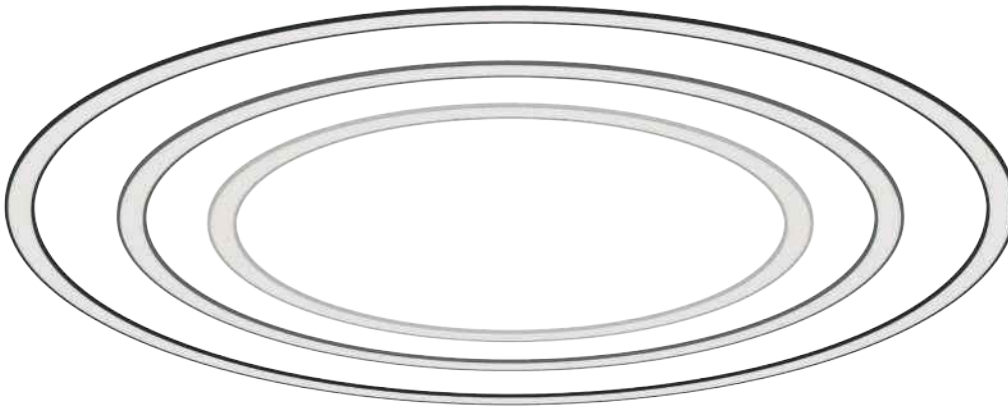





# MUTE

## SPECIAL SHAPES

Luminaires with acoustic panel version available as Quad, Hexagon or Ring.

## 2 MOUNTING VERSIONS

The luminaire is available as surface or pendant luminaire.

## DIFFERENT COLOURS

The housing is available in RAL 9005 black, RAL 9006 silver and RAL 9016 white – RAL of your choice on demand.

## HIGHEST QUALITY

The acoustic elements are acoustically tested in accordance with ISO 354.

## LARGE VARIATION

The acoustic elements are available in black, light grey mottled, anthracite mottled, burgundy red and olive green.

## ACOUSTIC MATERIAL

Made of at least 60% recycled PET.  
Fire Classification B-s2, d0 (EN13501-1:3018).

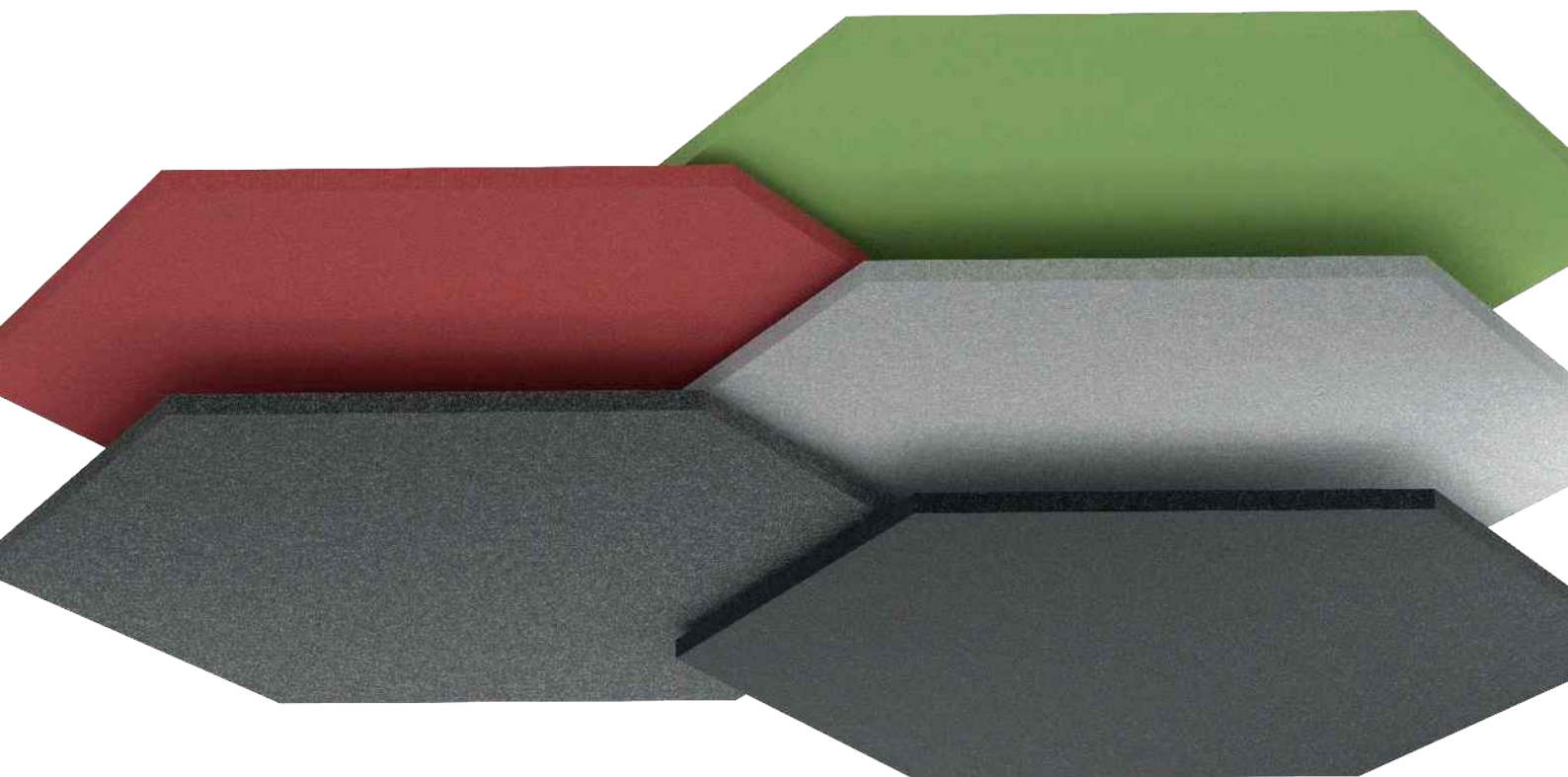



# RING50mute

ÜBERSICHT | OVERVIEW | VUE D'ENSEMBLE

ANBAULEUCHE | SURFACE MOUNTED LUMINAIRE | LUMINAIRE EN SAILLIE

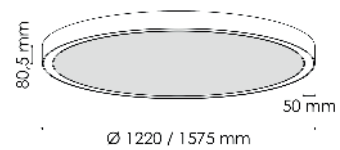

HÄNGELEUCHE | PENDANT LUMINAIRE | SUSPENSION

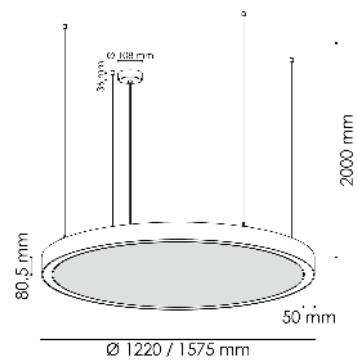

# LINE50HEXmute

ÜBERSICHT | OVERVIEW | VUE D'ENSEMBLE

ANBAULEUCHTE | SURFACE MOUNTED LUMINAIRE | LUMINAIRE EN SAILLIE

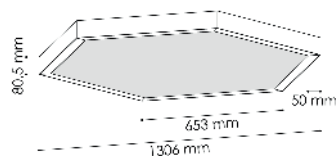

HÄNGELEUCHTE | PENDANT LUMINAIRE | SUSPENSION

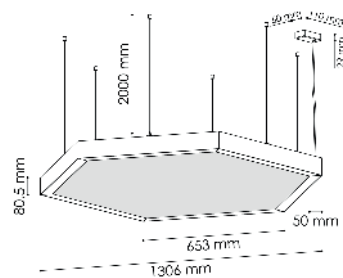

# LINE50QUADmute

ÜBERSICHT | OVERVIEW | VUE D'ENSEMBLE

ANBAULEUCHTE | SURFACE MOUNTED LUMINAIRE | LUMINAIRE EN SAILLIE

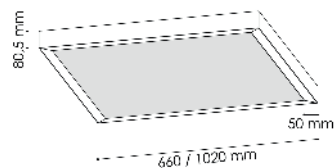
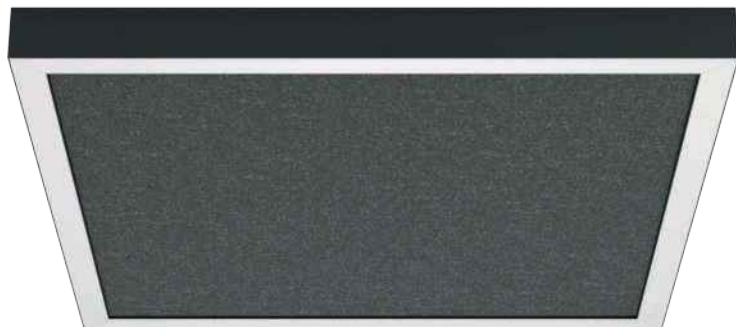

HÄNGELEUCHTE | PENDANT LUMINAIRE | SUSPENSION

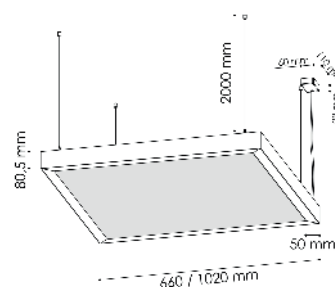
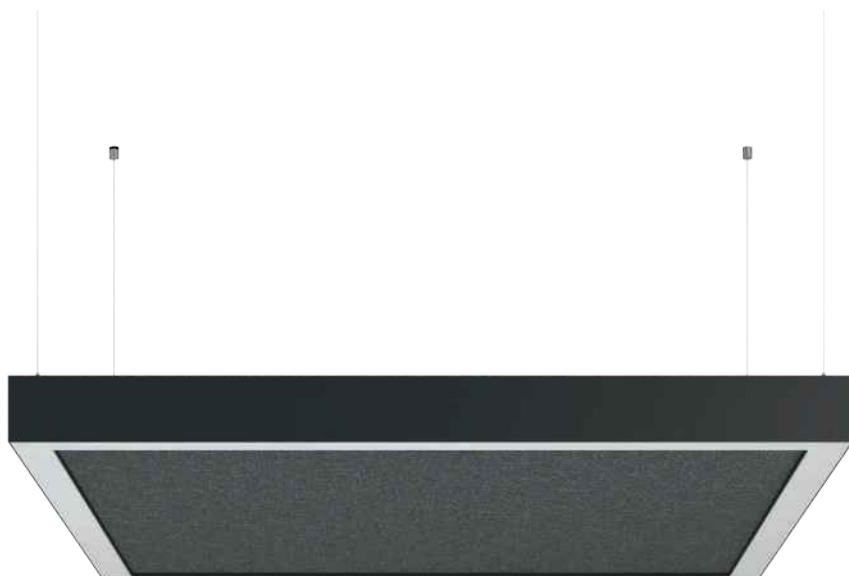



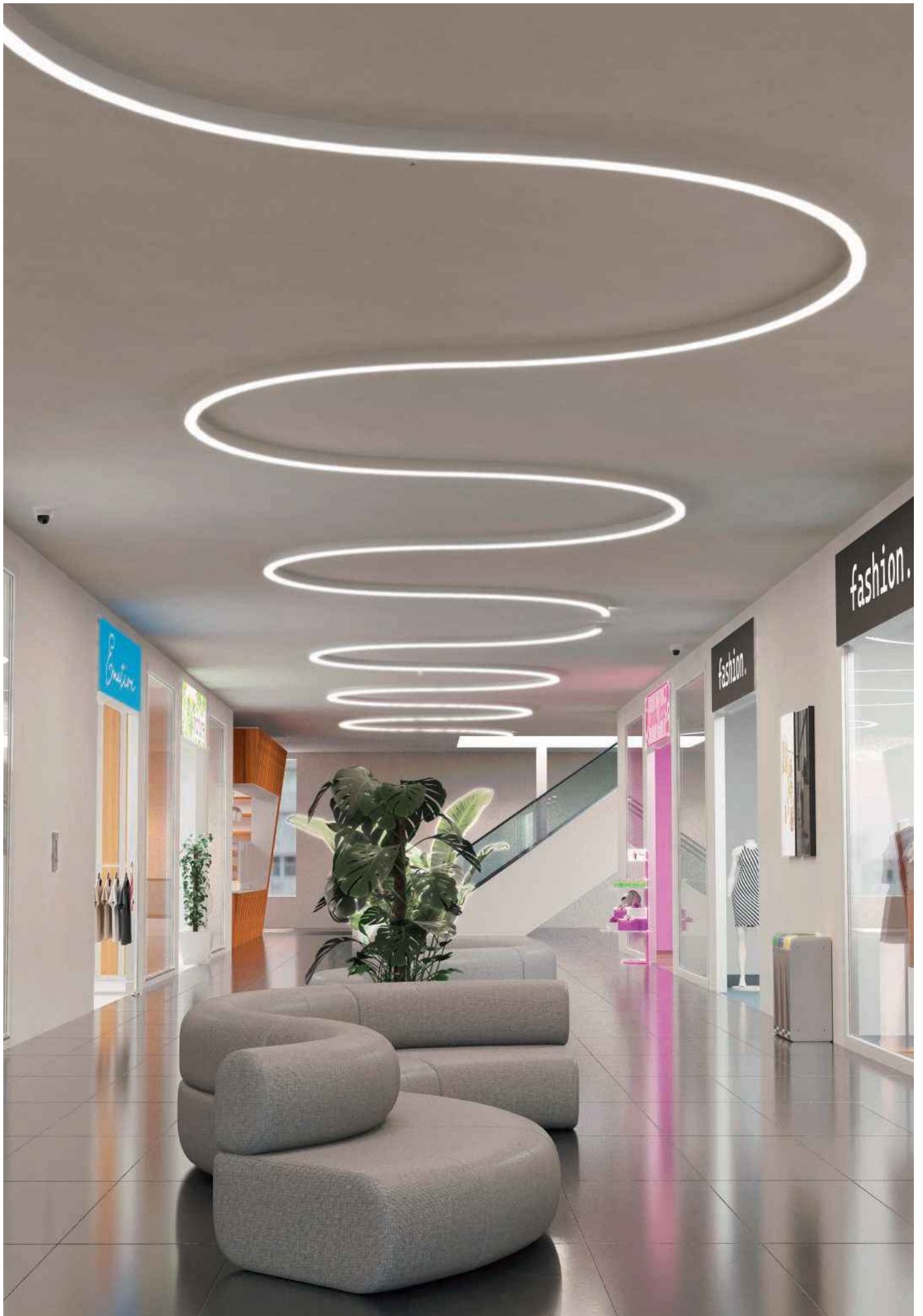



# FLEX50

## HIGH EFFICIENCY

The high luminous output at low power provides an energy efficient luminaire – up to 136 lm/W.

## 3 MOUNTING VERSIONS

The luminaire is available as surface, pendant or recessed luminaire.

## DIFFERENT COLOURS

The housing is available in RAL 9005 black, RAL 9006 silver and RAL 9016 white – RAL of your choice on demand.

## LARGE SELECTION OF SIZES

With 13 different segments – curved and straight – you can create nearly any shape.

## LIGHT WHERE YOU WANT IT

The luminaire is available either with direct light only or also with additional indirect light.

## DYNAMIC WHITE

Besides the unicoloured colour temperatures, dynamic white (2700K–6500K) is also available.

## MAKE YOUR WISH COME TRUE

An including emergency light or many other options are available on demand.

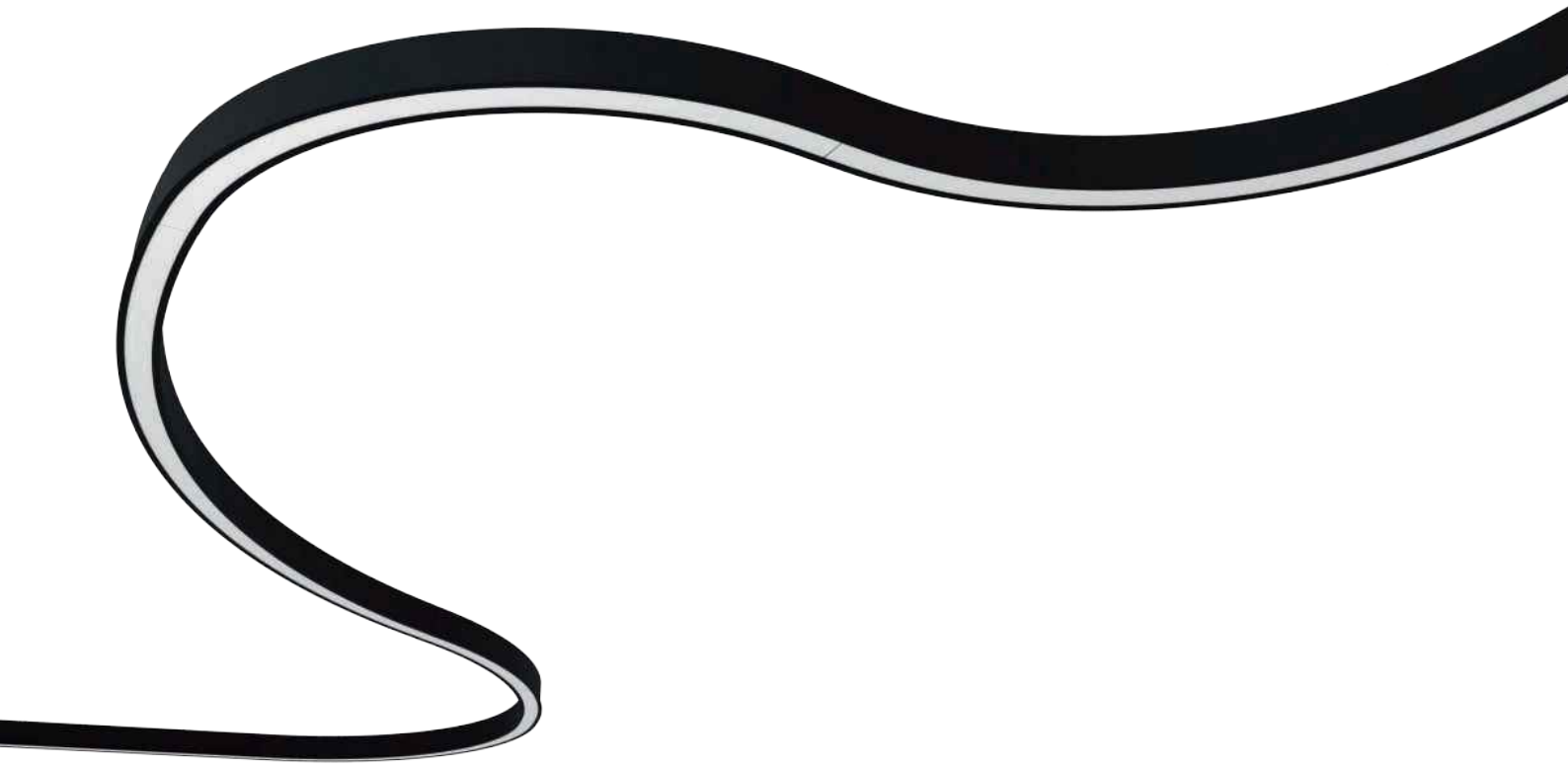



# FLEX50

ÜBERSICHT | OVERVIEW | VUE D'ENSEMBLE

ANBAULEUCHE | SURFACE MOUNTED LUMINAIRE | LUMINAIRE EN SAILLIE

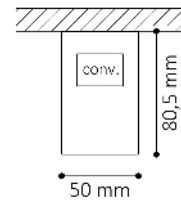

HÄNGELEUCHE | PENDANT LUMINAIRE | SUSPENSION

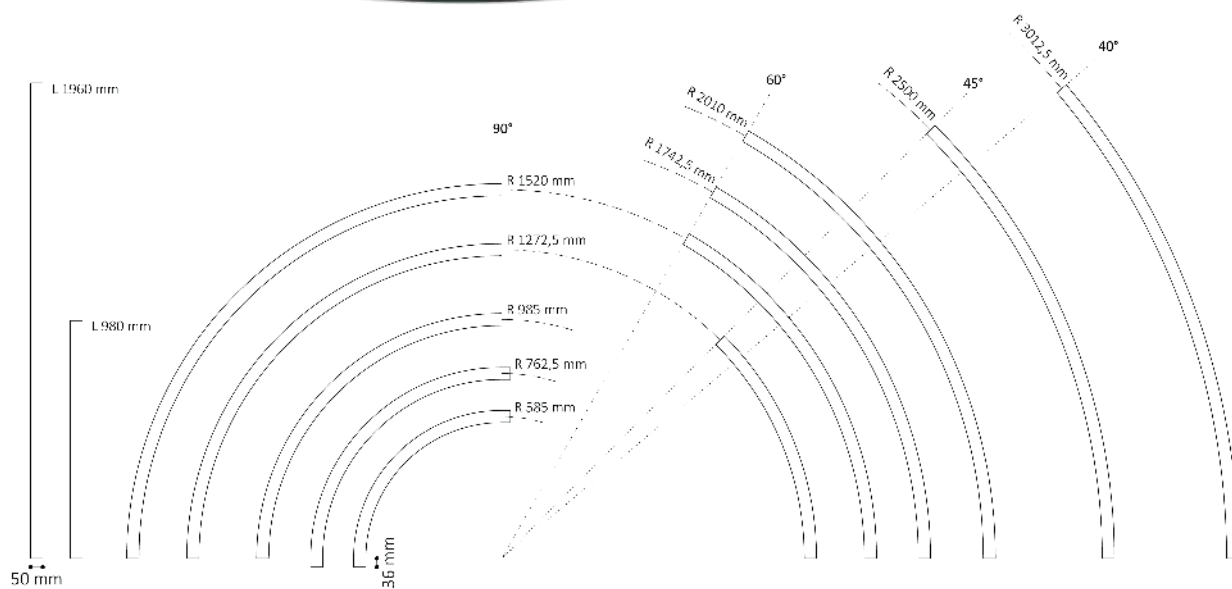
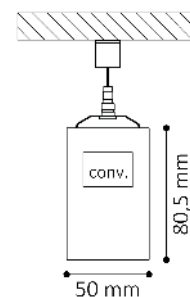

# FLEX50

ÜBERSICHT | OVERVIEW | VUE D'ENSEMBLE

EINBAULEUCHE | RECESSED LUMINAIRE | LUMINAIRE ENCASTRABLE

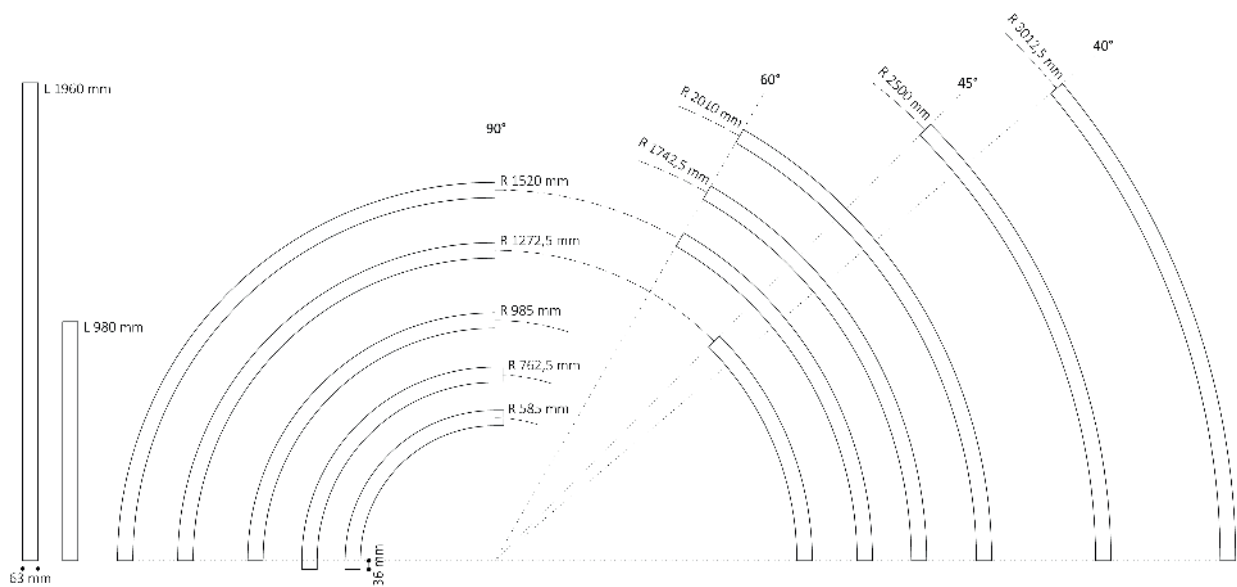
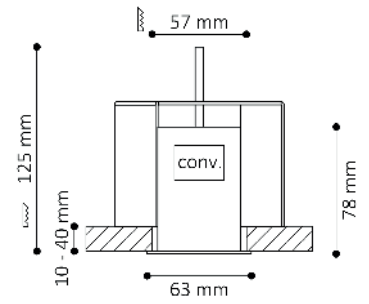

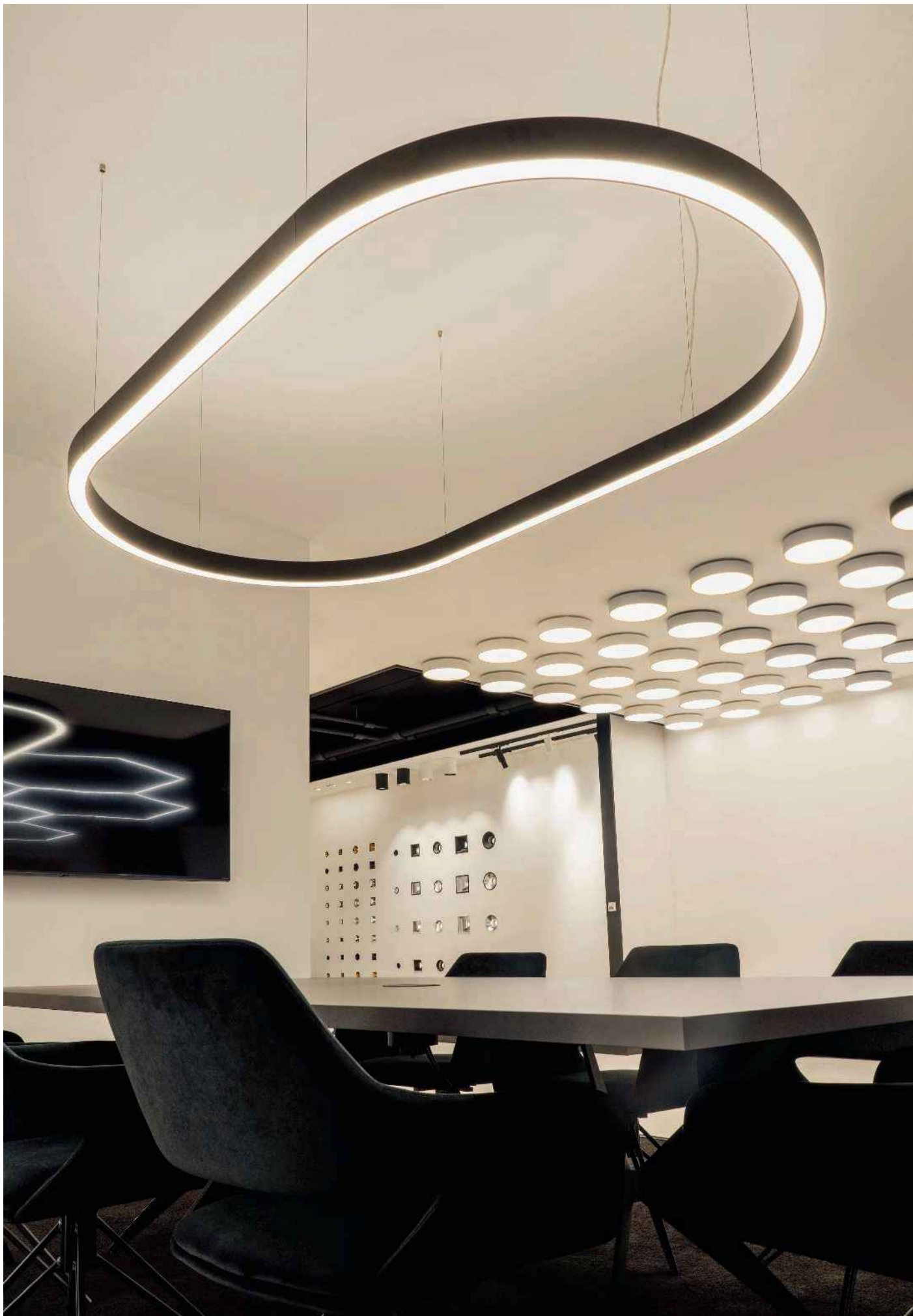

# OVOID50

## HIGH EFFICIENCY

The high luminous output at low power provides an energy efficient luminaire – up to 120 lm/W.

## 2 MOUNTING VERSIONS

The luminaire is available as surface-mounted or pendant luminaire.

## DIFFERENT COLOURS

The housing is available in RAL 9005 black, and RAL 9016 white – RAL of your choice on demand.

## LIGHT WHERE YOU WANT IT

The luminaire is available either with direct light only or also with additional indirect light.

## DYNAMIC WHITE

Besides the unicoloured colour temperatures dynamic white (2700K-6500K) is also available.

## MAKE YOUR WISHES COME TRUE

An including emergency light or many other options are available on demand.

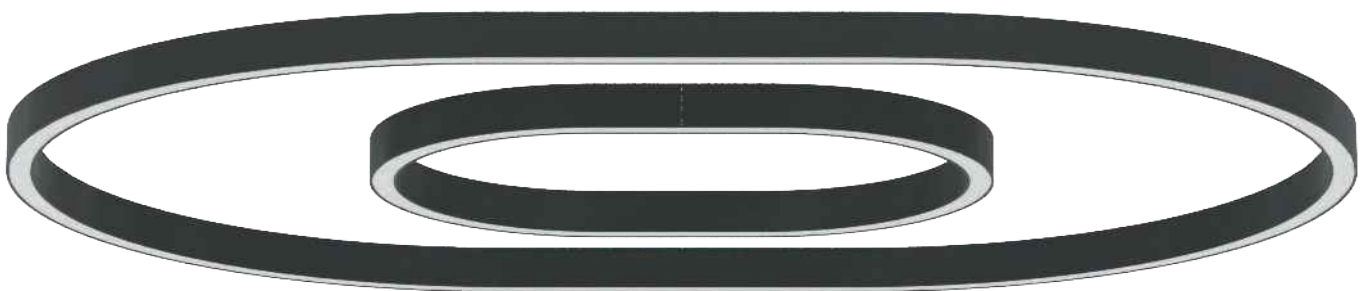

# OVOID50

ÜBERSICHT | OVERVIEW | VUE D'ENSEMBLE

ANBAULEUCHE | SURFACE MOUNTED LUMINAIRE | LUMINAIRE EN SAILLIE

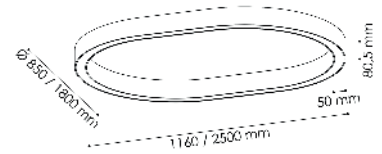

HÄNGELEUCHE | PENDANT LUMINAIRE | SUSPENSION

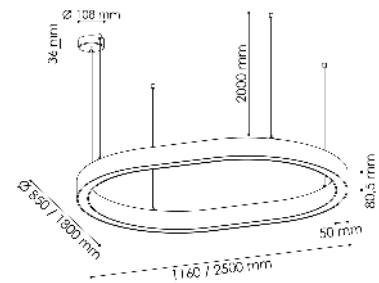

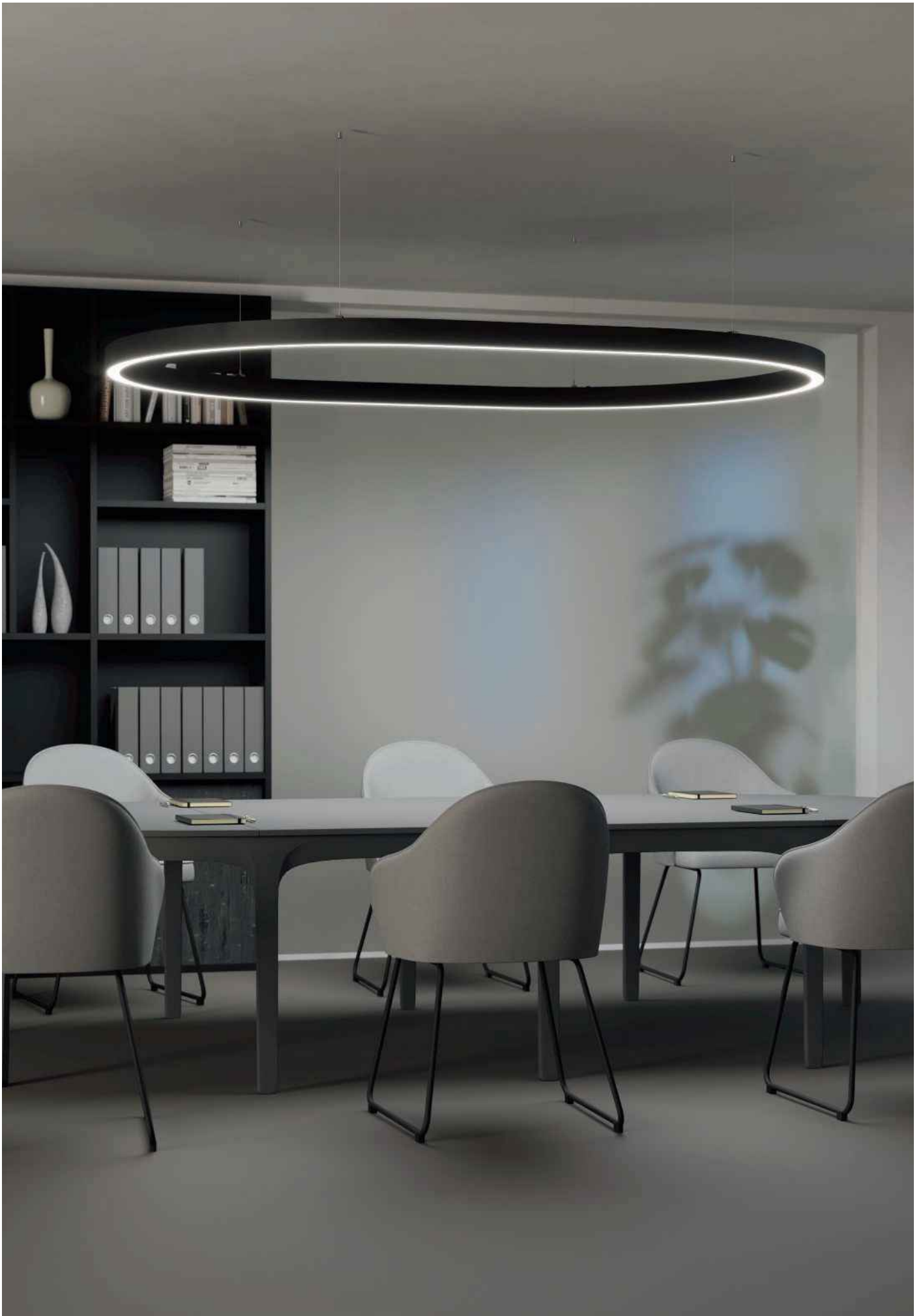





# ROUND90

## HIGH EFFICIENCY

The high luminous output at low power provides an energy efficient luminaire - up to 174 lm/W.

## SLIDE & LIGHT

Simply sliding the housing into the canopy allows an easy installation of the surface luminaire.

## NO INSECTS – NO PROBLEMS

With an IP50 rating, the luminaire housing is protected against insects and dust.

## MAKE YOUR WISH COME TRUE

Besides the unicoloured colour temperatures, dynamic white (2700K–6500K) is also available.

## LIGHT WHERE YOU WANT IT

The luminaire is available either with direct light only or also with additional indirect light.

## ROTATE & FIX

The recessed luminaire can be fixed easily into the mounting frame by inserting and rotating

## DYNAMIC WHITE

Besides the unicoloured colour temperatures, dynamic white (2700K–6500K) is also available.

## 4 DIFFERENT SIZES DIFFERENT SUSPENSION TYPES



## KEEP IT SIMPLE BUT MAKE IT UNIQUE

- 3 different housing colours
- 6 different decoration ring colours
- RAL colour of your choice on demand



# ROUND90

ÜBERSICHT | OVERVIEW | VUE D'ENSEMBLE

## ANBAULEUCHTE | SURFACE MOUNTED LUMINAIRE | LUMINAIRE EN SAILLIE

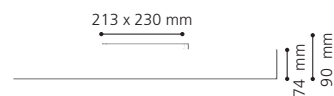

DIRECT

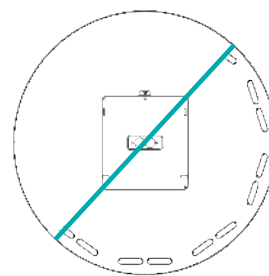

DIRECT + INDIRECT

Ø 350 / 450 / 650 / 950 mm

## WANDLEUCHTE | WALL LUMINAIRE | APPLIQUE MURALE



DIRECT

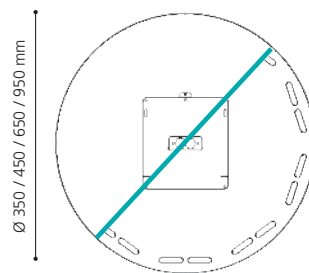

DIRECT + INDIRECT

Ø 350 / 450 / 650 / 950 mm



## EINBAULEUCHTE | RECESSED LUMINAIRE | LUMINAIRE ENCASTRABLE

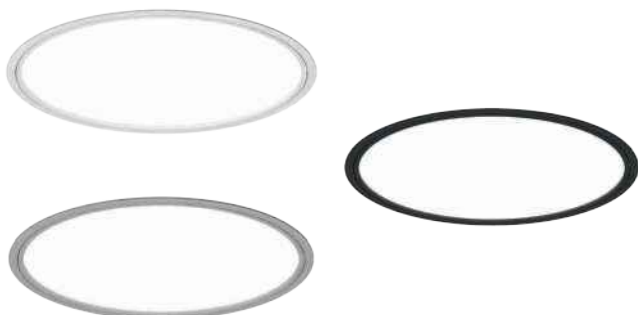

cutout Ø 368 / 468 / 668 / 968 mm

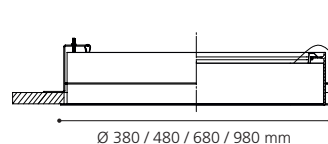

10-28 mm  
cutout 120 mm

Ø 380 / 480 / 680 / 980 mm

# ROUND90

ÜBERSICHT | OVERVIEW | VUE D'ENSEMBLE

HÄNGELEUCHE | PENDANT LUMINAIRE | SUSPENSION

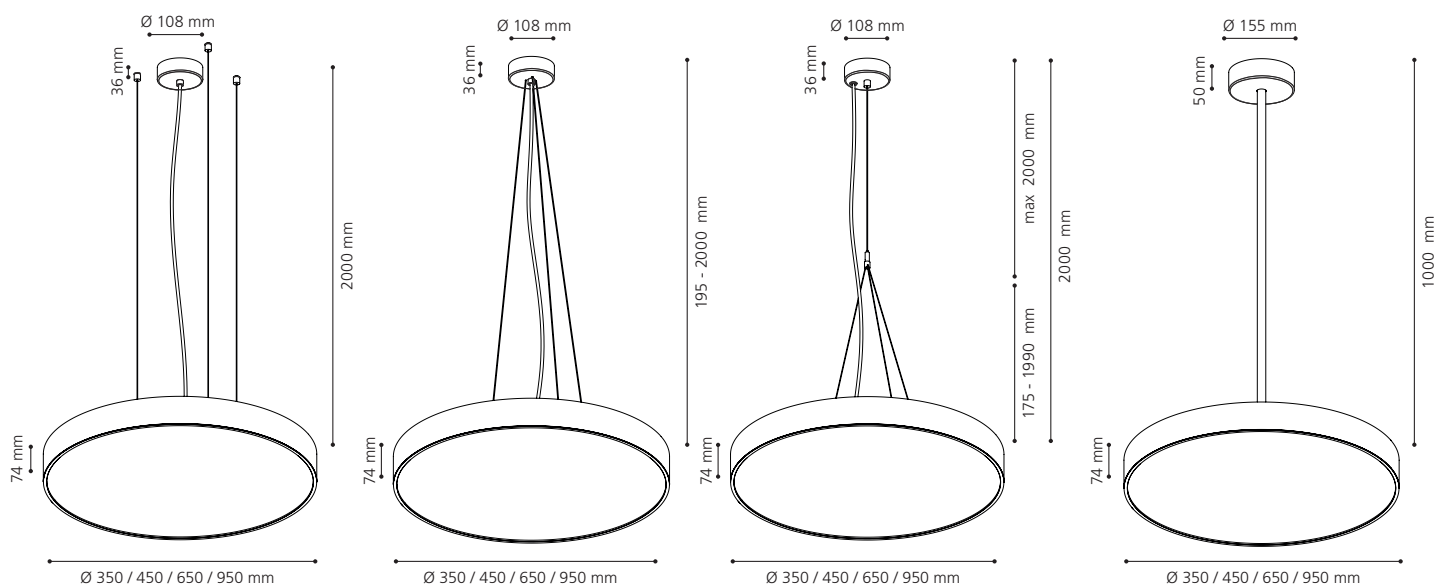

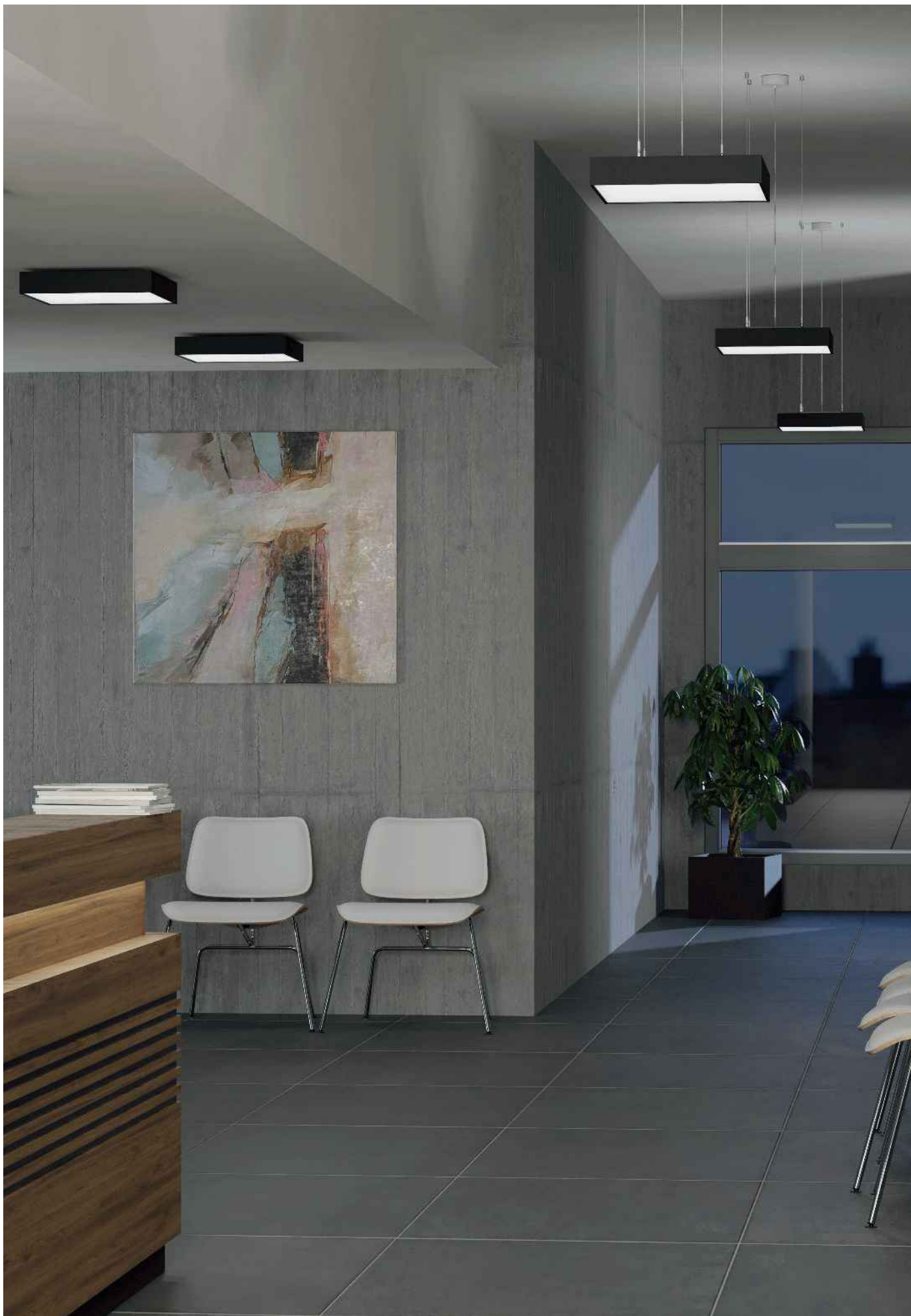

# SQUARE90

## HIGH EFFICIENCY

The high luminous output at low power provides an energy efficient luminaire - up to 175 lm/W.

## SLIDE & LIGHT

Simply sliding the housing into the canopy allows an easy installation of the surface luminaire.

## NO INSECTS – NO PROBLEMS

With an IP50 rating, the luminaire housing is protected against insects and dust.

## LIGHT WHERE YOU WANT IT

The luminaire is available either with direct light only or also with additional indirect lighting.

## DYNAMIC WHITE

Besides the unicoloured colour temperatures, dynamic white (2700K–6500K) is also available.

## MAKE YOUR WISH COME TRUE

An including sensor, emergency light or many other options are available on demand.

## 4 DIFFERENT SIZES 4 DIFFERENT SUSPENSION TYPES



## KEEP IT SIMPLE BUT MAKE IT UNIQUE

- 3 different housing colours
- 6 different decoration ring colours
- RAL colour of your choice on demand

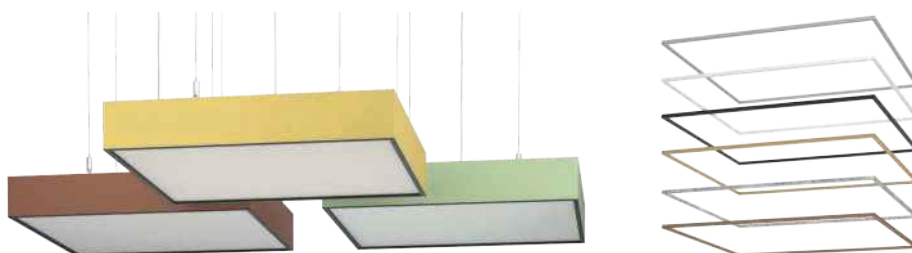



# SQUARE90

ÜBERSICHT | OVERVIEW | VUE D'ENSEMBLE

ANBAULEUCHE | SURFACE MOUNTED LUMINAIRE | LUMINAIRE EN SAILLIE

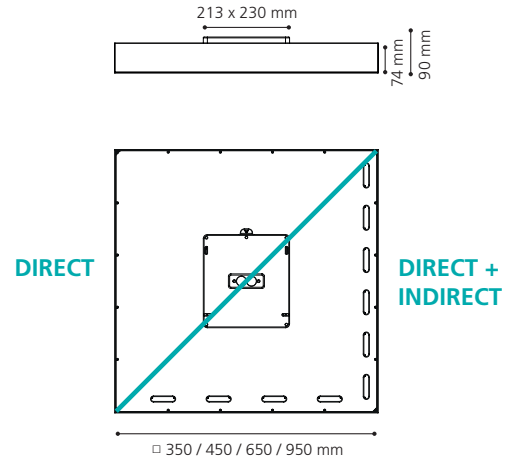

WANDLEUCHE | WALL LUMINAIRE | APPLIQUE MURALE

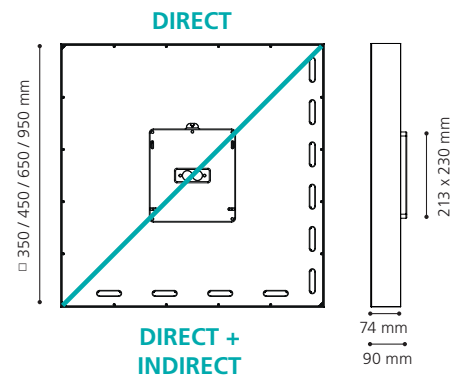

# SQUARE90

ÜBERSICHT | OVERVIEW | VUE D'ENSEMBLE

HÄNGELEUCHE | PENDANT LUMINAIRE | SUSPENSION

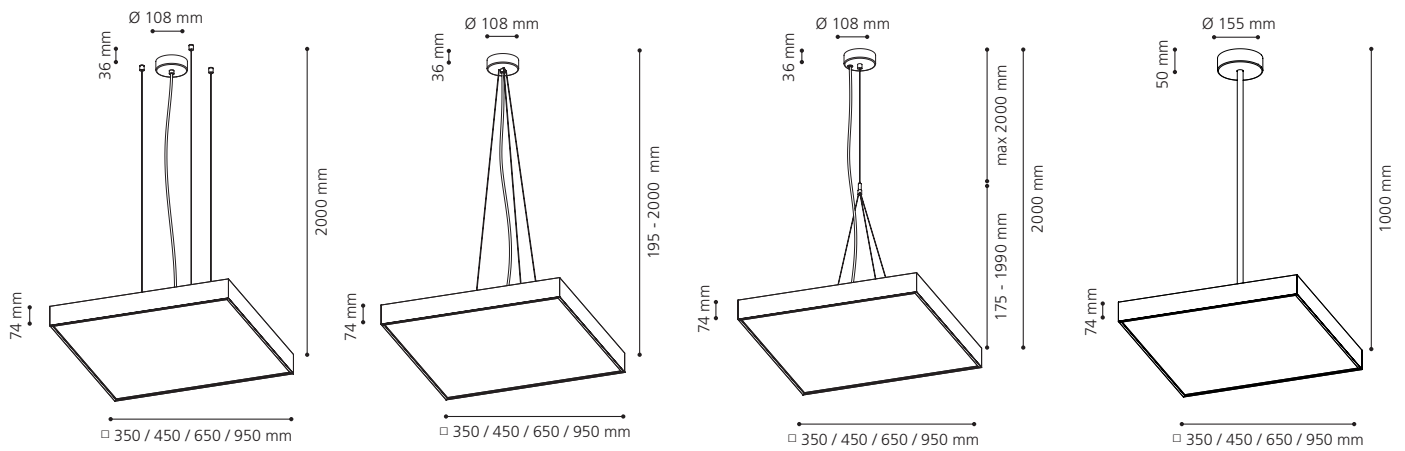



# ROPE22

## CREATE YOUR OWN LAYOUT

Various lengths from 1.2 to 10.0 meters are available to create the layout of your choice.

## 3 MOUNTING VERSIONS

ROPE22 includes a wide range of mounting accessories for surface, recessed and pendant installation.

## DIFFERENT COLOURS

The accessories are available in RAL 9005 black, and RAL 9016 white or in anodized midnight blue, anthracite or gold finish.

## HOMOGENOUS ILLUMINATION

ROPE22 creates a uniformly illuminated lighting experience with a 360° beam characteristic.

## THE RIGHT LIGHTING EXPERIENCE

With up to 1640 lm/m, the ROPE22 produced a powerful light output.

## DRIVER OPTIONS

Select the required driver option from on/off or DALI drivers.

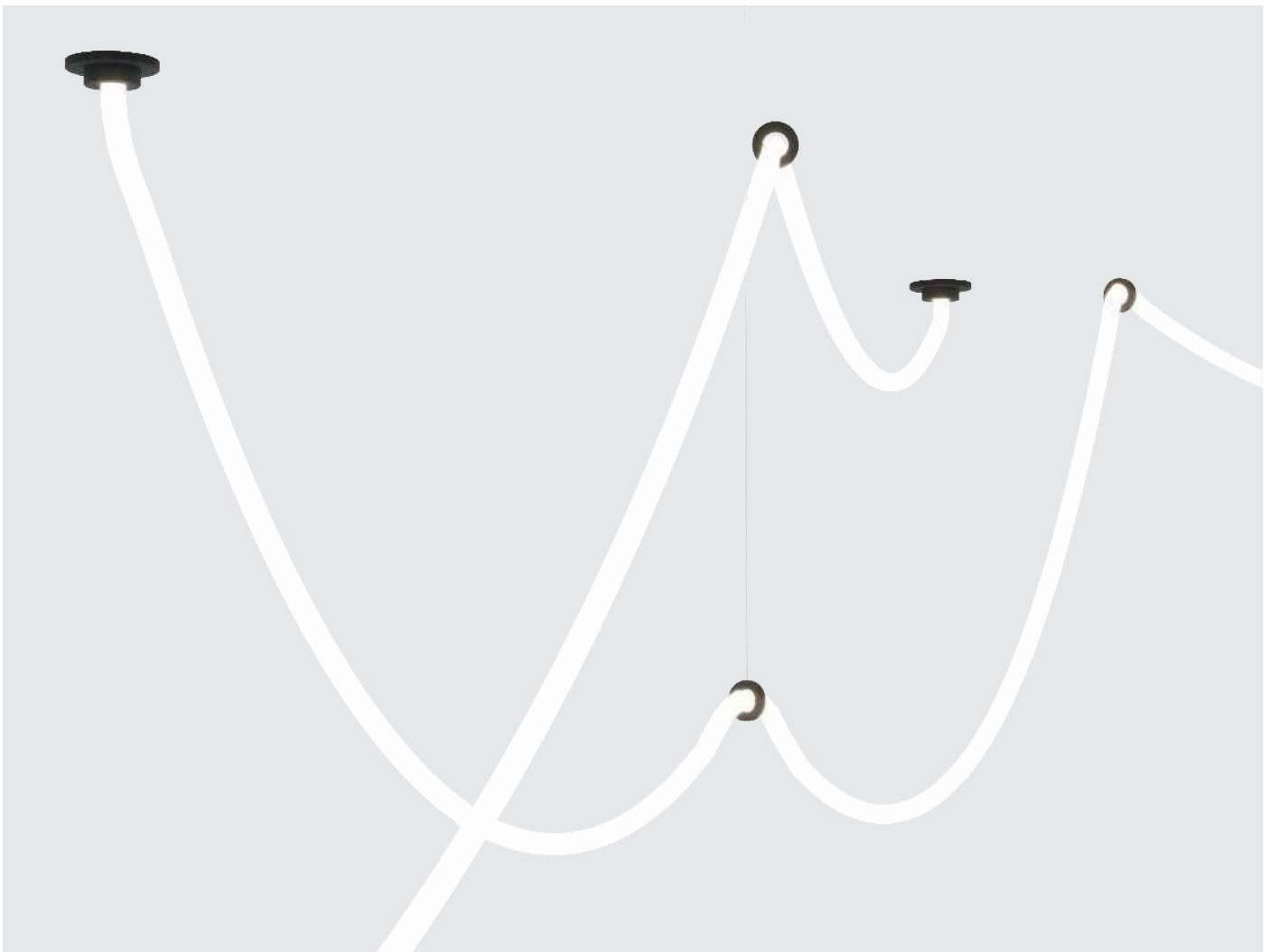





# DOWN75

## ROUND OR SQUARE?

The downlight is available either as a round or square shape.

## POWERFUL SOLUTION

With up to 1341lm, DOWN75 offers the right solution for every project.

## DIFFERENT COLOURS

The housing is available in RAL 9005 black, RAL 9006 silver and RAL 9016 white – RAL of your choice on demand.

## SELECT THE RIGHT ANGLE

DOWN75 is available with beam angles of 23° and 45°.

## THE RIGHT POWER LEVEL

DOWN75 is available in two different output levels - low output (63 mm height) and high output (87 mm height).

## DRIVER OPTIONS

Select the required driver option from on/off, TRIAC or DALI drivers.





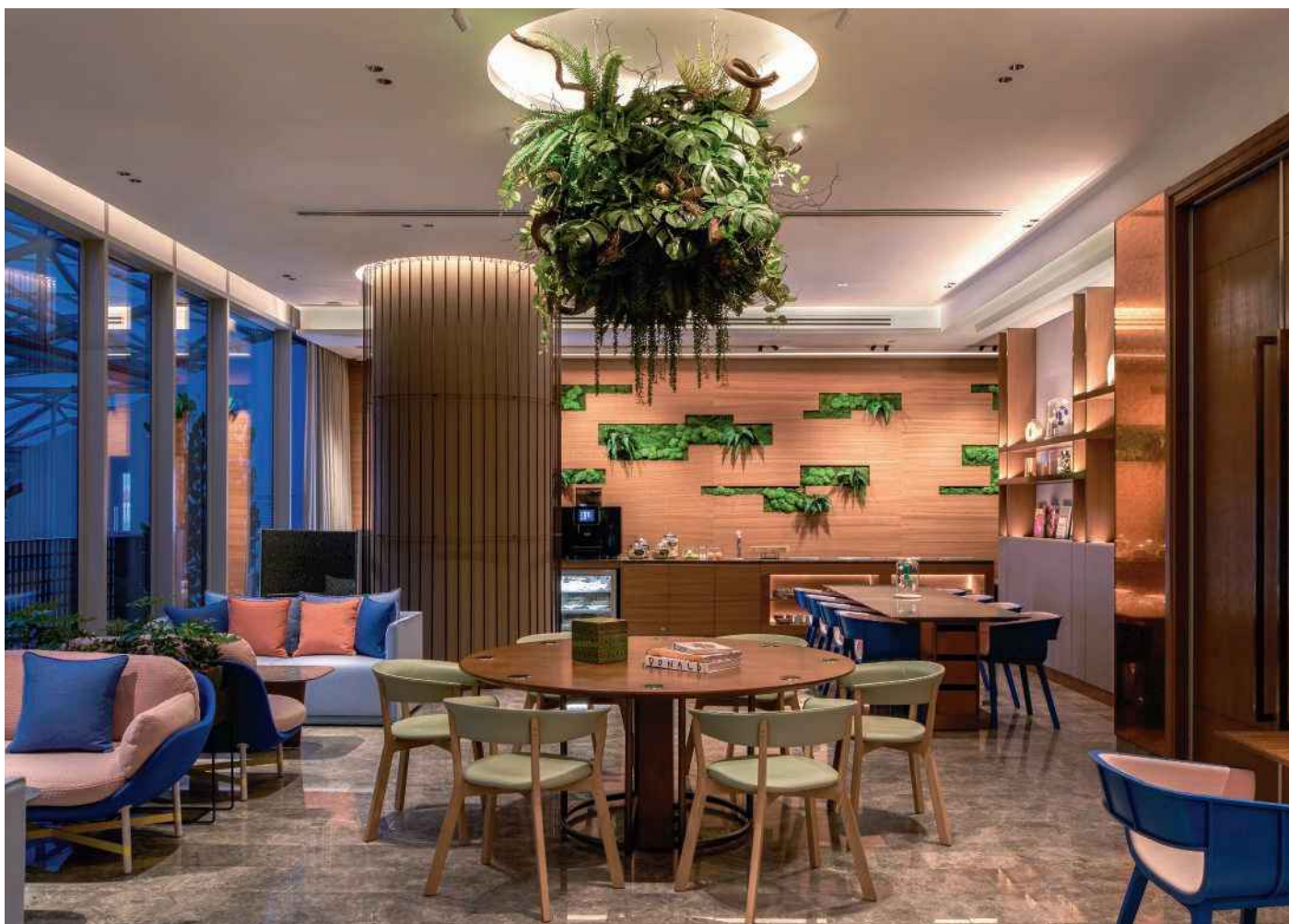

# designDOT/SQOT

## DOT OR SQOT?

The recessed spot is available either as a round or square shape.

## DIFFERENT SIZES

For each shape there are 2 different sizes – 68 or 100 mm.

## COLOUR VARIANTS

2 housing colours and 4 different reflector colours and finishes are available.

## NOT ONLY SYMMETRICAL

The 100 mm size is also available with an asymmetric beam angle – round and square.





# designDOT

ÜBERSICHT | OVERVIEW | VUE D'ENSEMBLE

## designDOT68

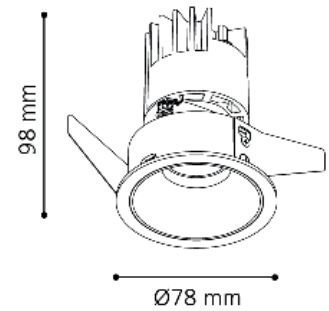

## designDOT100

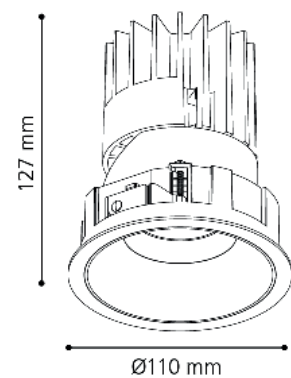

# designSQOT

ÜBERSICHT | OVERVIEW | VUE D'ENSEMBLE

## designSQOT68

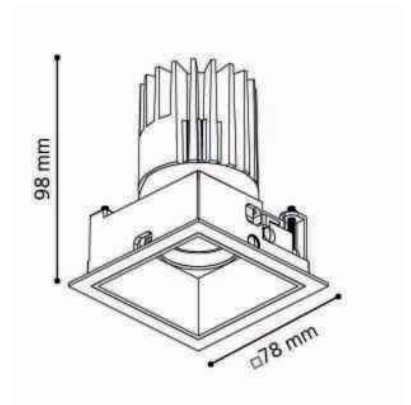

## designSQOT100

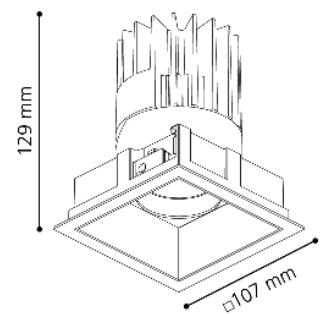
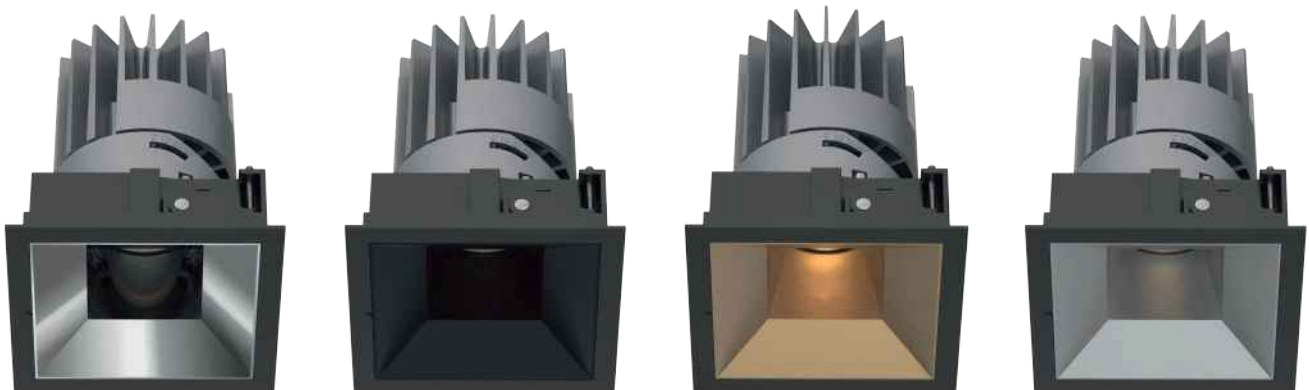



# techDOT/SQOT

## DOT OR SQOT?

The spot is available either as a round or square shape.

## SURFACE VERSION

techDOT is also available as a surface spot with 151mm diameter.

## COLOUR VARIANTS

2 housing colours and 2 different reflector colours are available.

## DOT SIZES

The DOT recessed version is available in 3 different sizes – 75, 150 & 200 mm.

## SQOT SIZES

The SQOT is available as recessed spot in 2 different sizes – 150 & 200 mm.

## DYNAMIC WHITE 150 & 200 VERSION

Besides the unicoloured colour temperatures, dynamic white (2700K–6500K) is also available.





# techDOT

ÜBERSICHT | OVERVIEW | VUE D'ENSEMBLE

## techDOT75

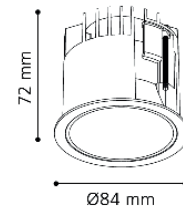

## techDOT150

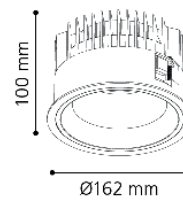

## techDOT200

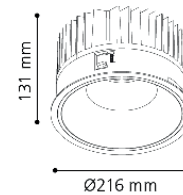

## techDOT150surface

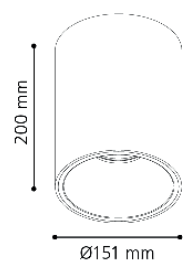

# techSQOT

ÜBERSICHT | OVERVIEW | VUE D'ENSEMBLE

## techSQOT150

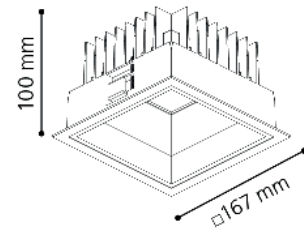

## techSQOT200

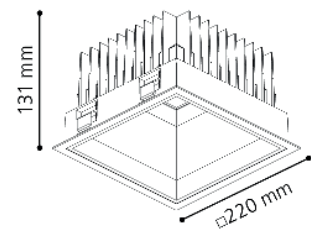

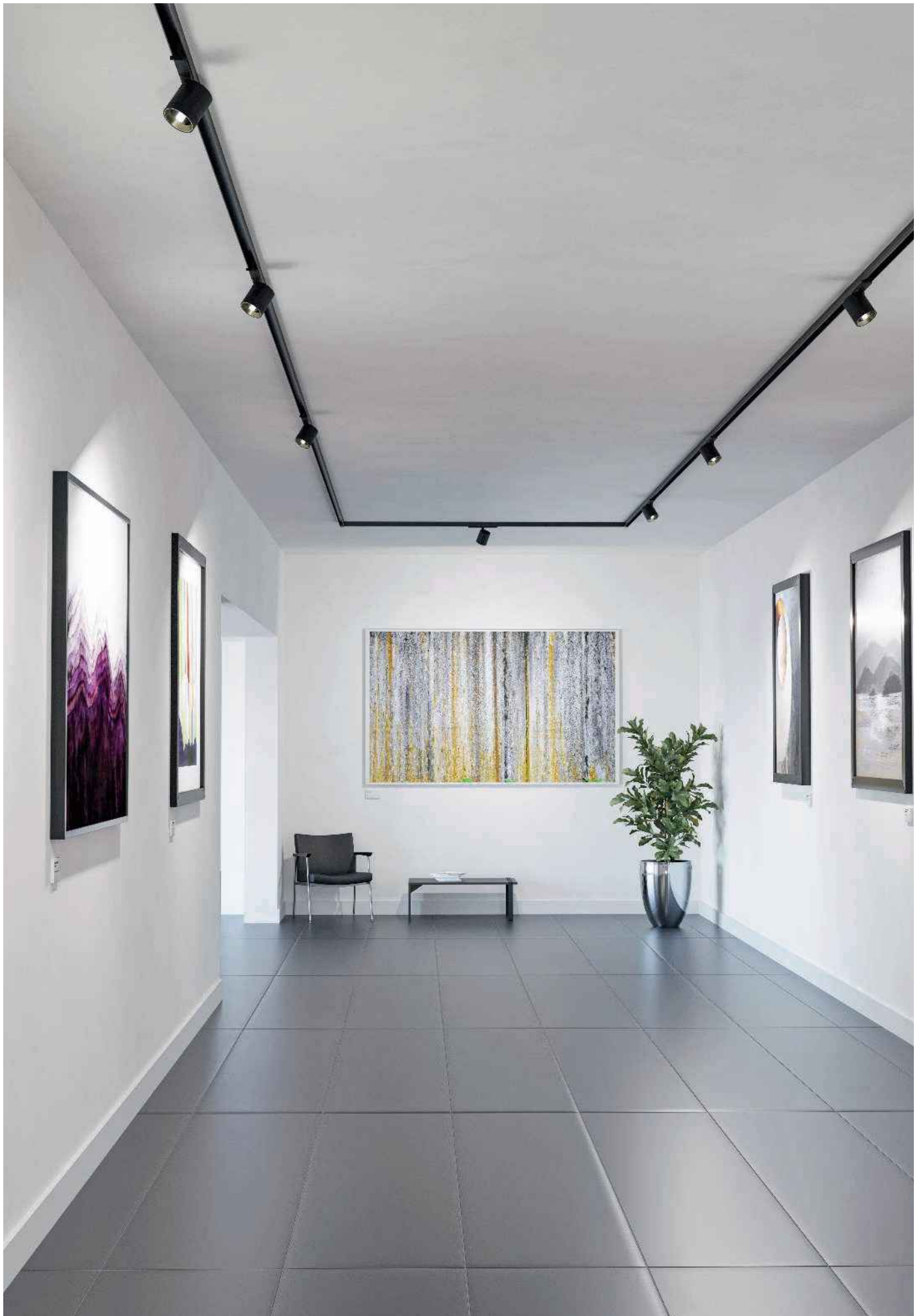

# GLOW

## ALL INTEGRATED

The rotatable, swivelling 3-phase track spotlights have an inTrack driver on/off or DALI.

## POWERFUL SOLUTION

With a total of six sizes with up to 4.834lm, GLOW offers the right solution for every project.

## DIFFERENT COLOURS

The housing is available in RAL 9005 black, and RAL 9016 white – RAL of your choice on demand.

## GU10 VERSION AVAILABLE

Version with GU10 bulb in diameter Ø 90 mm with up to 655lm available.

## LARGE VARIATION

The luminaire is equipped with a high-quality decoration ring with a choice of eight different colours – specular or matt.

## THE MATCHING LIGHT

GLOWmedium, GLOWlarge and GLOWultra has special COBs for different areas like fashion, bakery, meat, etc....

GLOWmini



GLOWsmall



GLOWmedium



GLOWlarge



GLOWultra



GLOWgu10



# GLOW

ÜBERSICHT | OVERVIEW | VUE D'ENSEMBLE

## GLOWmini

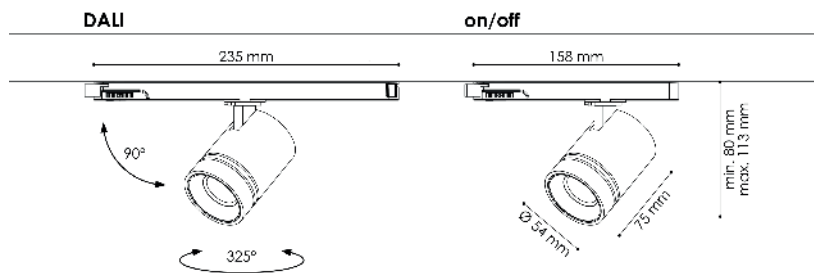

# GLOW

ÜBERSICHT | OVERVIEW | VUE D'ENSEMBLE

## GLOWsmall

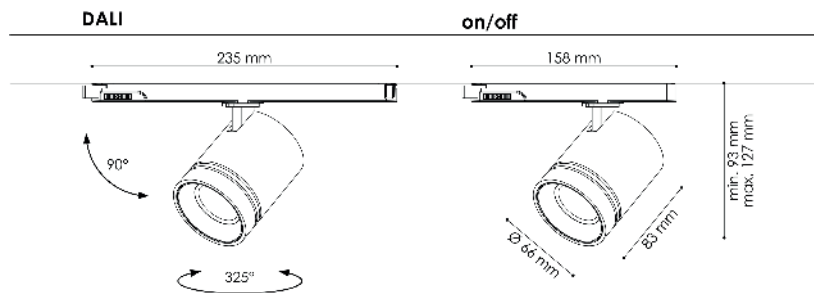



# GLOW

ÜBERSICHT | OVERVIEW | VUE D'ENSEMBLE

## GLOWmedium

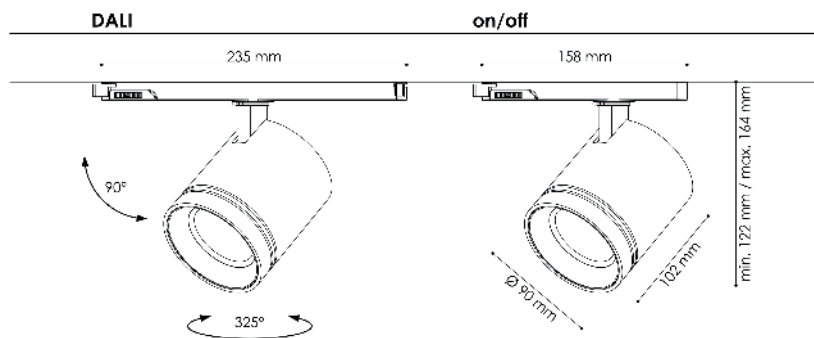

# GLOW

ÜBERSICHT | OVERVIEW | VUE D'ENSEMBLE

## GLOWlarge

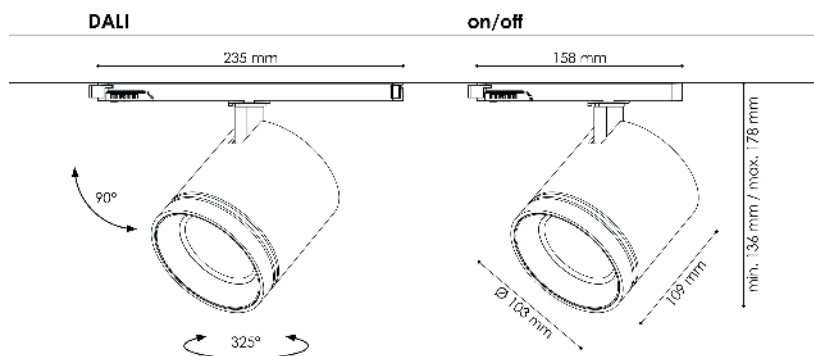

# GLOW

ÜBERSICHT | OVERVIEW | VUE D'ENSEMBLE

## GLOWultra

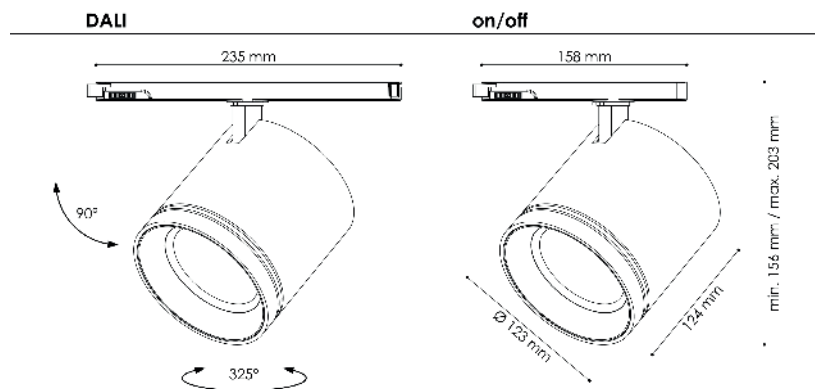

# GLOW

ÜBERSICHT | OVERVIEW | VUE D'ENSEMBLE

## GLOWgu10

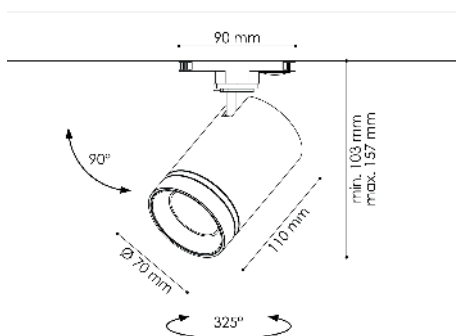

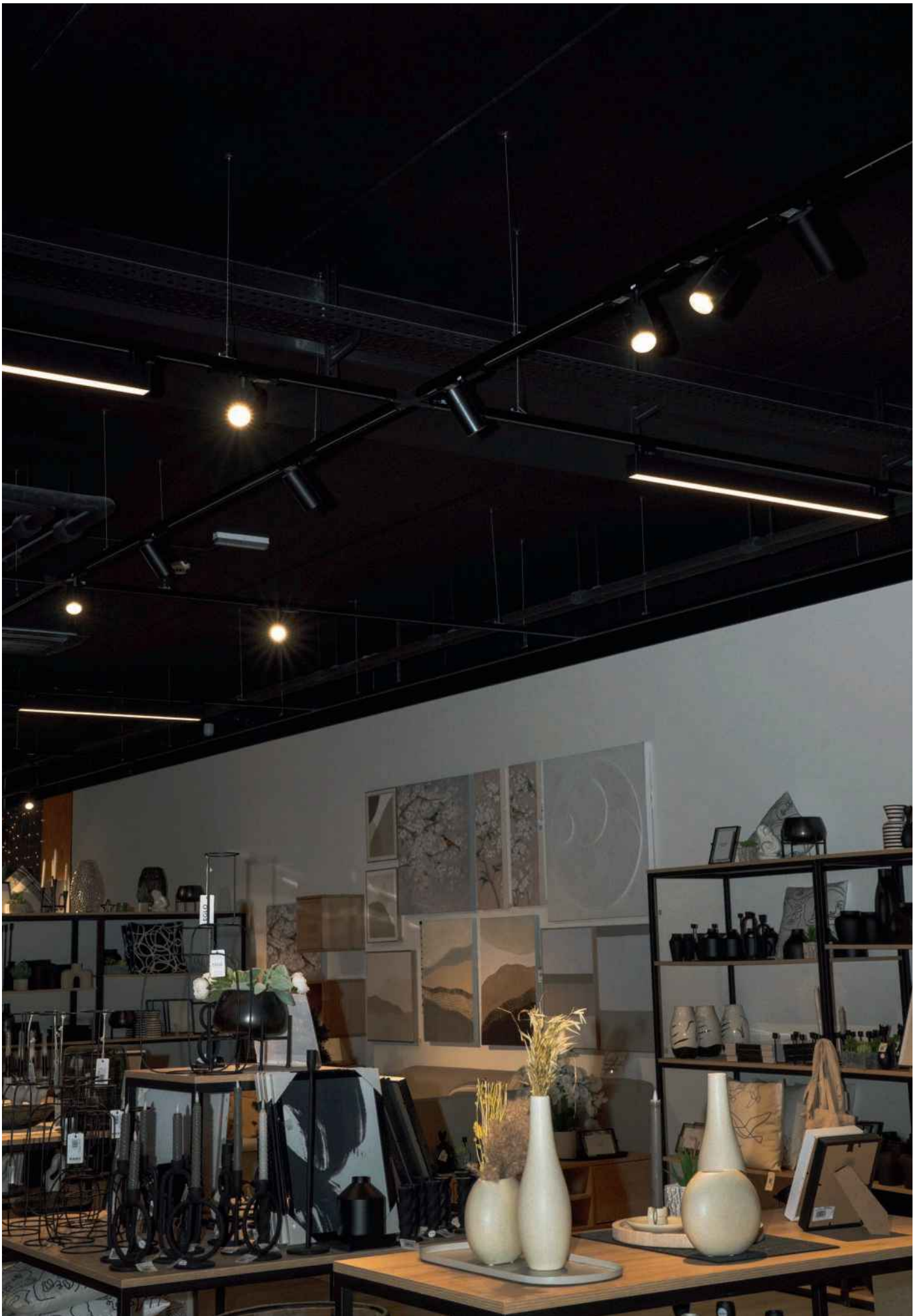

# trackS/M

## ALL INTEGRATED

The rotatable, swivelling 3-phase track spotlights have an inTrack adapter on/off or DALI.

## NARROW OR WIDE

Different beam angles are available – 18°/36°/50° for trackS – 20°/55° for trackM.

## SMALL OR MEDIUM

The 150 mm long spot head is either available with a diameter of 55 or 72 mm.

## THE MATCHING LIGHT

trackM has special colour temperatures for different areas like fashion, bakery, meat, etc.

trackS



trackM



trackS



trackM





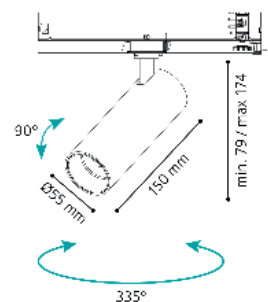

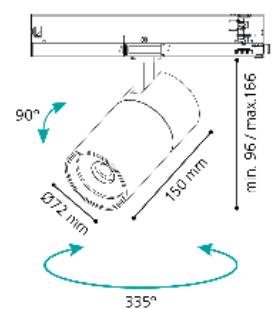



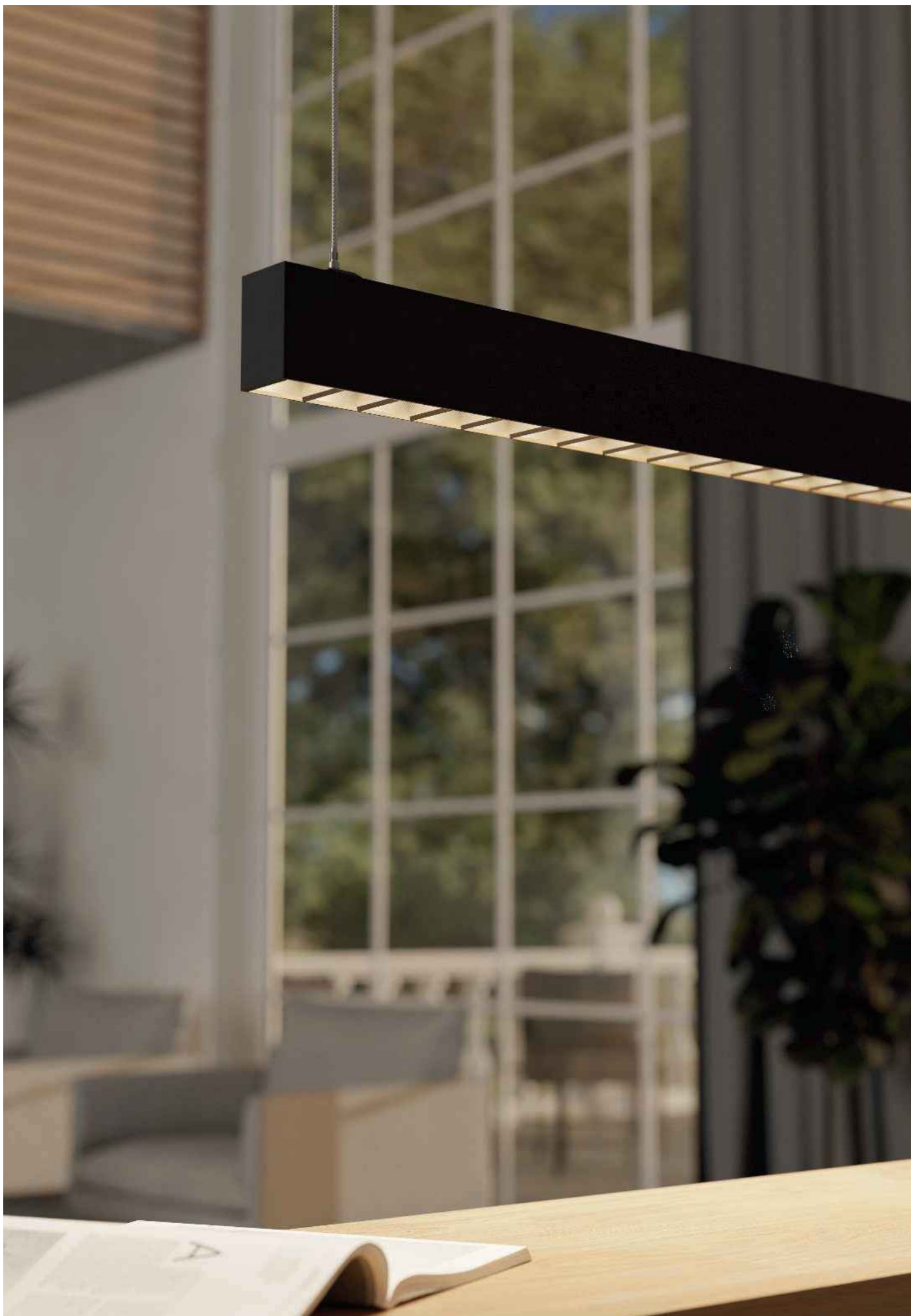



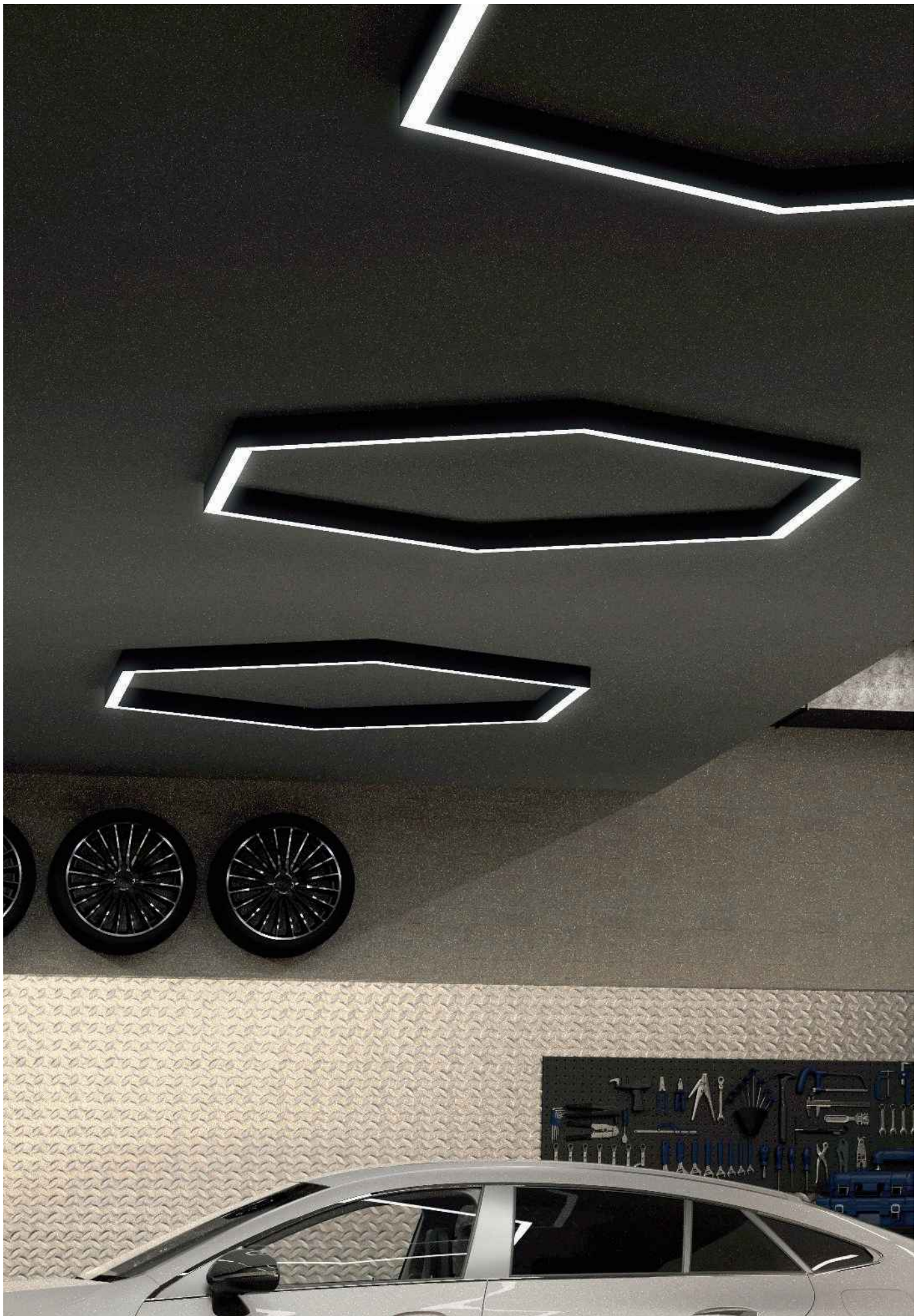

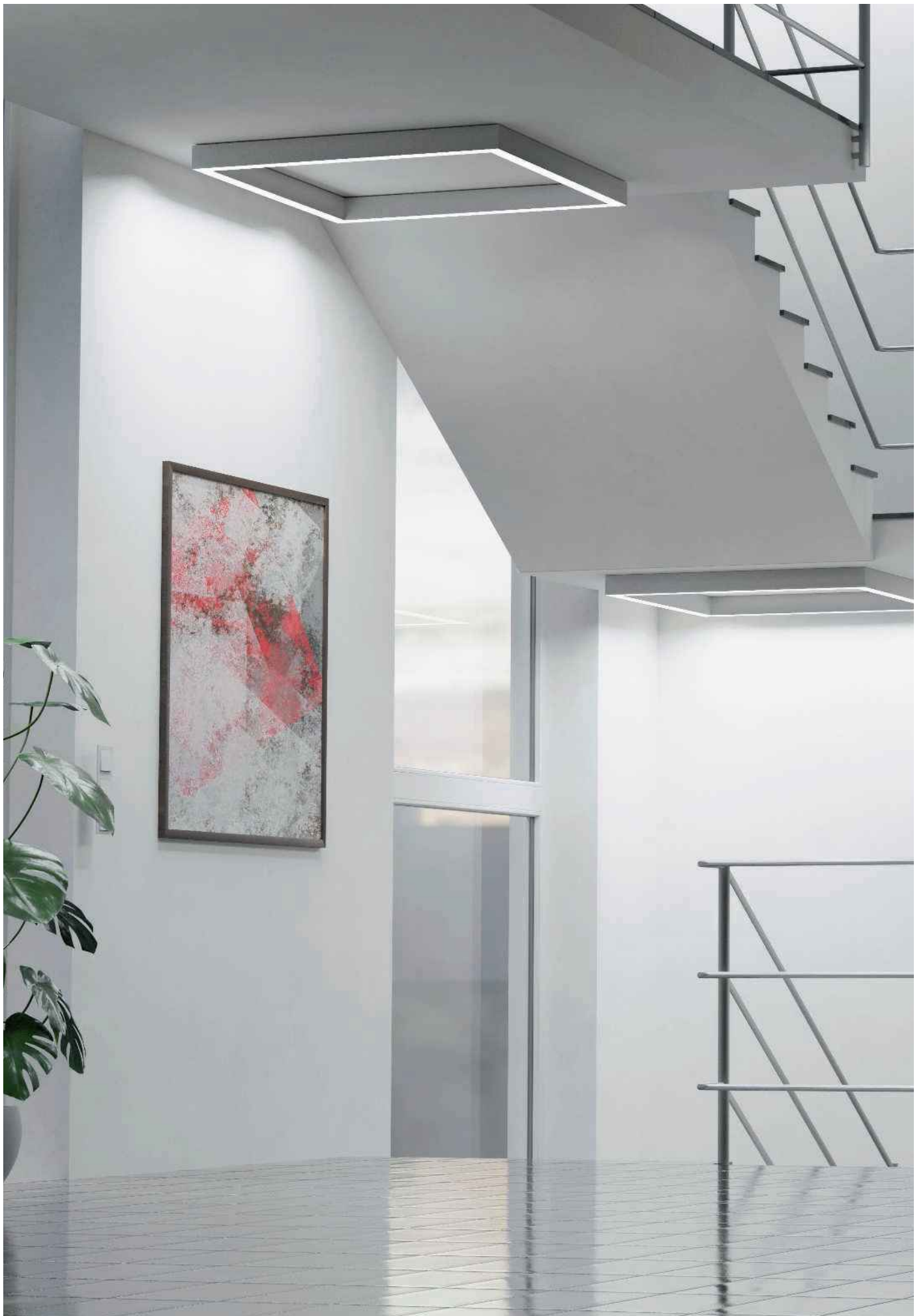











# OVERVIEW

ANBAULEUCHTEN | SURFACE MOUNTED LUMINAIRES | LUMINAIRES EN SAILLIE



LINE40  
**112**



LINE50  
**114**



LINE50hex  
**116**



LINE50HEXmute  
**118**



LINE50quad  
**120**



LINE50QUADmute  
**122**



LINE50splash  
**124**



officeLINE50  
**126**



LINE70  
**128**



RING50  
**130**



RING50mute  
**132**



FLEX50  
**134**



OVOID50  
**136**



ROUND90  
**138**



SQUARE90  
**140**



techDOT150surface  
**142**



# ANBAULEUCHTEN

SURFACE MOUNTED LUMINAIRES

*LUMINAIRES EN SAILLIE*



# LINE40

ANBAULEUCHE | SURFACE MOUNTED LUMINAIRE | LUMINAIRE EN SAILLIE

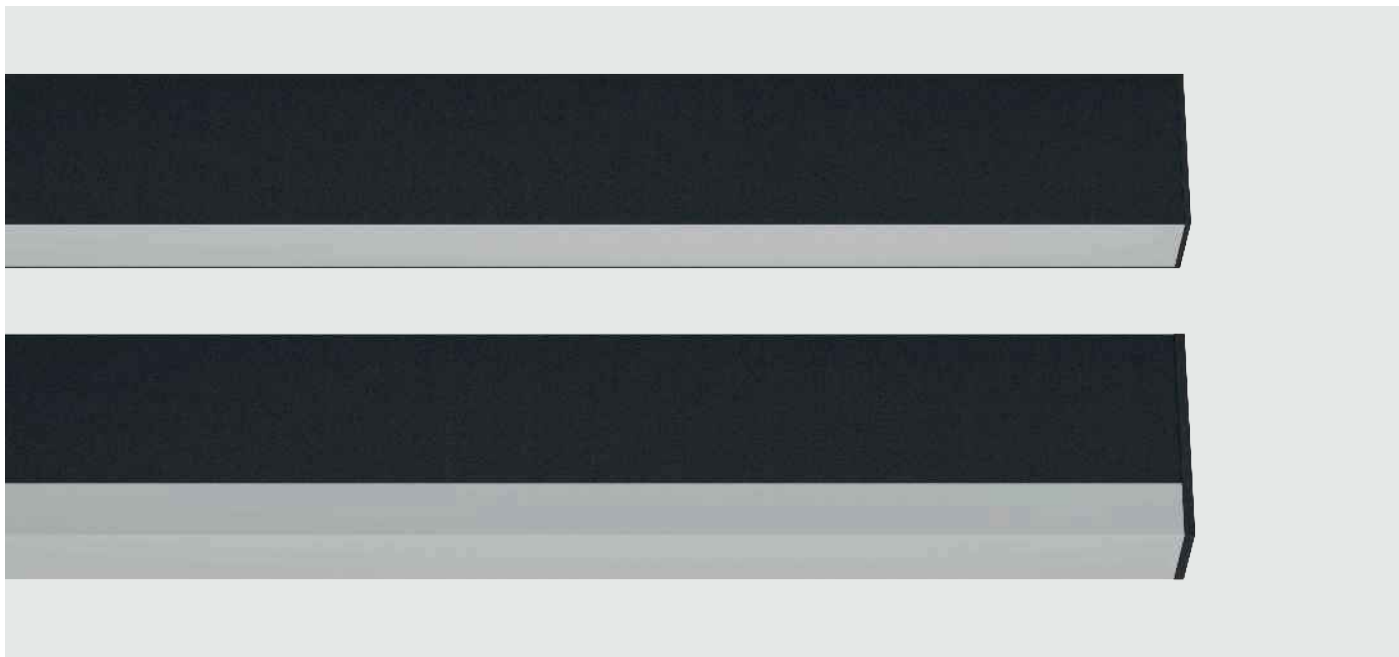

**LED-Anbauleuchte** direktstrahlend. Lichtkanal aus Aluminium-Strangpressprofil mit einer Breite von 41 mm. Fertigung der Leuchtenlänge millimetergenau auf Kundenwunsch möglich. Oberfläche der Leuchte feinstruktur matt pulverbeschichtet ähnlich RAL 9016 weiß, RAL 9006 silber oder RAL 9005 schwarz – auf Anfrage in RAL nach Wahl. Diffusor wahlweise in PMMA opal, PMMA opal U-Abdeckung oder PMMA klar mit eingeschobener mikroprismatischer Platte für eine reduzierte Leuchtdichte (UGR<19). Der LED-Treiber ist im Leuchtengehäuse integriert – wahlweise als on/off oder DALI-Variante. Farbtemperaturen 2700K, 3000K, 4000K oder dynamisch Weiß (2700K-6500K) – Farbwiedergabe CRI>80 oder CRI>90 – Mac Adam ≤3. Weitere Steuerungsoptionen oder Lichtfarben auf Anfrage erhältlich. Außerdem ist die Integration vieler Komponenten, wie beispielsweise Notlicht oder Sensortechnologie, sowie eine Vielzahl weiterer Optionen möglich.

**Surface mounted LED luminaire** with direct beam. Light channel made of extruded aluminium profile with a width of 41 mm. Luminaire length can be manufactured to the exact millimetre on customer request. Surface of the luminaire fine structure matt powder coated similar to RAL 9016 white, RAL 9006 silver or RAL 9005 black - on request in RAL of choice. Diffuser either in PMMA opal, PMMA opal U-cover or PMMA clear with inserted microprismatic plate for reduced luminance (UGR<19). The LED driver is integrated in the luminaire housing - either as on/off or DALI version. Colour temperatures 2700K, 3000K, 4000K or dynamic white (2700K-6500K) - colour rendering CRI>80 or CRI>90 - Mac Adam ≤3. Further control options or light colours available on request. In addition, the integration of many components, such as emergency lighting or sensor technology, as well as a variety of other options is possible.

**Luminaire de surface LED** en saillie à éclairage direct. Canal lumineux en profilé d'aluminium extrudé d'une largeur de 41 mm. Possibilité de fabriquer la longueur du luminaire au millimètre près sur demande du client. Surface du luminaire à structure fine matte revêtue de poudre similaire à RAL 9016 blanc, RAL 9006 argent ou RAL 9005 noir - sur demande en RAL au choix. Diffuseur au choix en PMMA opale, PMMA opale cache U ou PMMA transparent avec plaque microprismatique insérée pour un éblouissement réduit (UGR<19). Le pilote LED est intégré dans le boîtier du luminaire - au choix sous forme de variante on/off ou DALI. Températures de couleur 2700K, 3000K, 4000K ou blanc dynamique (2700K-6500K) - Rendu des couleurs CRI>80 ou CRI>90 - Mac Adam ≤3. Autres options de commande ou couleurs de lumière disponibles sur demande. En outre, l'intégration de nombreux composants, tels que l'éclairage de secours ou des capteurs, une multitude d'autres options sont possibles.

## ÜBERSICHT | OVERVIEW | VUE D'ENSEMBLE

### TECHNICAL DATA

2700K / 3000K / 4000K / 2700-6500K

CRI>80 / CRI>90

MacAdam ≤ 3

up to 124 lm/W, up to 2.849 lm/m

on-off / DALI

direct

opal / U-cover / microprism (UGR <19)

L80 B10 50.000h

### HOUSING COLOUR

schwarz | black | noir  
RAL 9005

silber | silver | argent  
RAL 9006

weiß | white | blanc  
RAL 9016



RAL colour of your choice



Integration of Multisensor



Welded mitre cuts



Integration of emergency light



Contact us for more options...

# ANBAULEUCHE „LINE40“

SURFACE MOUNTED LUMINAIRE "LINE40"  
LUMINAIRE EN SAILLIE « LINE40 »

Bestellbeispiel | Example order | Exemple de commande

3.132 mm, CRI>90, 4000K, **direct**, low output on/off, black, microprism

**LI40A-319401-LOBLM**

1 2 3 4 5 6

1 LÄNGE LENGTH LONGEUR	
612 mm	06
972 mm	09
1.212 mm	12
1.452 mm	14
1.692 mm	16
1.932 mm	19
2.172 mm	21
2.412 mm	24
2.892 mm	28
3.132 mm	31
3.854 mm	38

2 FARBWIEDERGABE COLOUR RENDERING RENDU DES COULEURS	
CRI>80	8
CRI>90	9

3 FARBTEMPERATUR COLOUR TEMPERATURE TEMPÉRATURE DE COULEUR	
2700K (CRI>90 only)	27
3000K	30
4000K	40
2700-6500K (CRI>90 only)	DW

4 LEISTUNG & STEUERUNG OUTPUT & CONTROL SORTIE & CONTRÔLE	
low output on/off	LO
low output DALI	LD
high output on/off	HO
high output DALI	HD
dynamic white DALI DT8	DW

5 GEHÄUSEFARBE HOUSING COLOUR COULEUR DU BOÎTIER	
silver RAL 9006	SI
white RAL 9016	WH
black RAL 9005	BL

6 DIFFUSOR DIFFUSER DIFFUSEUR	
opal	O
microprism	M
U-cover	U

direct

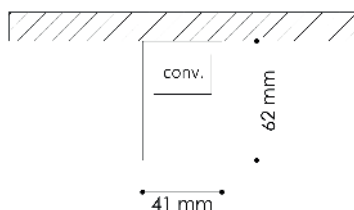

direct U-cover

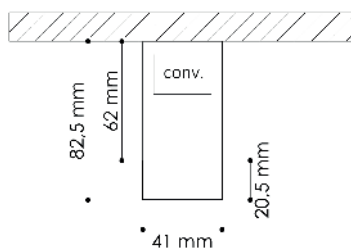

opal direct

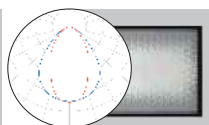

microprism direct

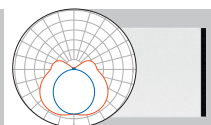

U-cover direct

Size [mm]	opal direct		microprism direct		U-cover direct		KG
	low output [lm] / [W]	high output [lm] / [W]	low output [lm] / [W]	high output [lm] / [W]	low output [lm] / [W]	high output [lm] / [W]	
612	840 / 8,8	1.495 / 16,3	876 / 8,8	1.560 / 16,3	864 / 8,8	1.538 / 16,3	1,4
972	1.324 / 13,0	2.461 / 25,0	1.381 / 13,0	2.567 / 25,0	1.362 / 13,0	2.532 / 25,0	2,1
1.212	1.777 / 16,3	3.150 / 30,0	1.854 / 16,3	3.286 / 30,0	1.828 / 16,3	3.241 / 30,0	2,6
1.452	2.010 / 18,5	3.763 / 35,8	2.097 / 18,5	3.925 / 35,8	2.068 / 18,5	3.871 / 35,8	3,2
1.692	2.398 / 21,2	4.470 / 41,1	2.501 / 21,2	4.663 / 41,1	2.467 / 21,2	4.599 / 41,1	3,7
1.932	2.779 / 23,7	5.222 / 46,3	2.889 / 23,7	5.448 / 46,3	2.859 / 23,7	5.373 / 46,3	4,2
2.172	3.157 / 26,6	5.931 / 52,0	3.293 / 26,6	6.187 / 52,0	3.248 / 26,6	6.102 / 52,0	4,7
2.412	3.441 / 29,2	6.544 / 57,3	3.590 / 29,2	6.826 / 57,3	3.541 / 29,2	6.732 / 57,3	5,3
2.892	3.880 / 34,3	7.570 / 69,6	4.048 / 34,3	7.897 / 69,6	3.992 / 34,3	7.788 / 69,6	6,4
3.132	4.326 / 36,9	8.516 / 75,5	4.513 / 36,9	8.884 / 75,5	4.451 / 36,9	8.761 / 75,5	6,8
3.854	5.558 / 47,4	10.444 / 92,6	5.798 / 47,4	10.896 / 92,6	5.718 / 47,4	10.746 / 92,6	8,5

Alle Lumenangaben für 4000K, CRI>80, Microprisma ohne Opalfolie

All lumen values for 4000K, CRI>80, microprism without opal foil

Toutes les données de lumens pour 4000K, CRI>80, microprisme sans feuille opale

# LINE50

ANBAULEUCHTE | SURFACE MOUNTED LUMINAIRE | LUMINAIRE EN SAILLIE

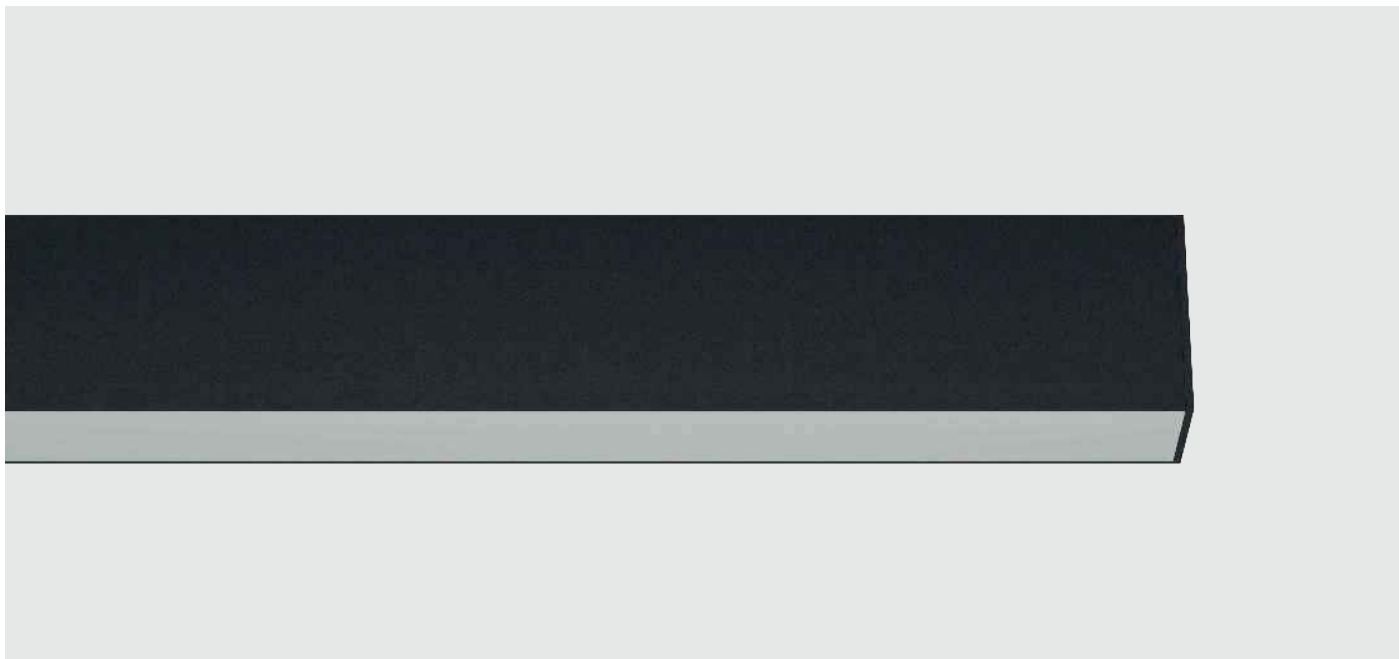

**LED-Anbauleuchte** direktstrahlend. Lichtkanal aus Aluminium-Strangpressprofil mit einer Breite von 50 mm. Fertigung der Leuchtenlänge millimetergenau auf Kundenwunsch möglich. Oberfläche der Leuchte feinstrukturiert matt pulverbeschichtet ähnlich RAL 9016 weiß, RAL 9006 silber oder RAL 9005 schwarz – auf Anfrage in RAL nach Wahl. Diffusor wahlweise in PMMA opal, PMMA klar mit eingeschobener asymmetrischer Folie oder PMMA klar mit eingeschobener mikroprismatischer Platte für eine reduzierte Leuchtdichte (UGR<19). Der LED-Treiber ist im Leuchtgehäuse integriert – wahlweise als on/off oder DALI-Variante. Farbtemperaturen 2700K, 3000K, 4000K oder dynamisch Weiß (2700K–6500K) – Farbwiedergabe CRI>80 oder CRI>90 – Mac Adam ≤3. Weitere Steuerungsoptionen oder Lichtfarben auf Anfrage erhältlich. Außerdem ist die Integration vieler Komponenten, wie beispielsweise Notlicht oder Sensortechnologie, sowie eine Vielzahl weiterer Optionen möglich.

**Surface mounted LED luminaire** with direct beam. Light channel made of extruded aluminium profile with a width of 50 mm. Luminaire length can be manufactured to the exact millimetre on customer request. Surface of the luminaire fine structure matt powder coated similar to RAL 9016 white, RAL 9006 silver or RAL 9005 black - on request in RAL of choice. Diffuser either in PMMA opal, PMMA clear with inserted asymmetrical foil or PMMA clear with inserted microprismatic plate for reduced luminance (UGR<19). The LED driver is integrated in the luminaire housing - either as on/off or DALI version. Colour temperatures 2700K, 3000K, 4000K or dynamic white (2700K-6500K) - colour rendering CRI>80 or CRI>90 - Mac Adam ≤3. Further control options or light colours available on request. In addition, the integration of many components, such as emergency lighting or sensor technology, as well as a variety of other options is possible.

**Luminaire de surface LED en saillie** à éclairage direct. Canal lumineux en profilé d'aluminium extrudé d'une largeur de 50 mm. Fabrication de la longueur du luminaire au millimètre près possible sur demande du client. Surface du luminaire à structure fine, revêtement par poudre mat similaire à RAL 9016 blanc, RAL 9006 argent ou RAL 9005 noir - sur demande en RAL au choix. Diffuseur au choix en PMMA opale, PMMA transparent avec feuille asymétrique insérée ou PMMA transparent avec plaque microprismatique insérée pour un éblouissement réduit (UGR<19). Le pilote LED est intégré dans le boîtier du luminaire - au choix sous forme de variante on/off ou DALI. Températures de couleur 2700K, 3000K, 4000K ou blanc dynamique (2700K-6500K) - Rendu des couleurs CRI>80 ou CRI>90 - Mac Adam ≤3. Autres options de commande ou couleurs de lumière disponibles sur demande. En outre, l'intégration de nombreux composants, tels que l'éclairage de secours ou la technologie de détection, une multitude d'autres options sont possibles.

## ÜBERSICHT | OVERVIEW | VUE D'ENSEMBLE

### TECHNICAL DATA

2700K / 3000K / 4000K / 2700-6500K

CRI>80 / CRI>90

MacAdam ≤ 3

up to 130 lm/W, up to 2.939 lm/m

on-off / DALI

direct

opal / microprism (UGR <19) / asymmetric

L80 B10 50.000h

### HOUSING COLOUR

schwarz | black | noir  
RAL 9005

silber | silver | argent  
RAL 9006

weiß | white | blanc  
RAL 9016



RAL colour of your choice



Integration of 3-phase-track



Integration of Multisensor



Welded mitre cuts



Integration of emergency light



Integration of GLOWmini/ GLOWsmall series



Contact us for more options...

**ANBAULEUCHTE „LINE50“**  
 SURFACE MOUNTED LUMINAIRE “LINE50”  
 LUMINAIRE EN SAILLIE « LINE50 »

Bestellbeispiel | Example order | Exemple de commande  
 3.134 mm, CRI>90, 4000K, **direct**, low output on/off, black, microprism

**LI50A-319401-LOBLM**

1 2 3 4 5 6

1 LÄNGE LENGTH LONGEUR	
614 mm	06
974 mm	09
1.214 mm	12
1.454 mm	14
1.694 mm	16
1.934 mm	19
2.174 mm	21
2.414 mm	24
2.894 mm	28
3.134 mm	31
3.856 mm	38

2 FARBWIEDERGABE COLOUR RENDERING RENDU DES COULEURS	
CRI>80	8
CRI>90	9

3 FARBTEMPERATUR COLOUR TEMPERATURE TEMPÉRATURE DE COULEUR	
2700K (CRI>90 only)	27
3000K	30
4000K	40
2700-6500K (CRI>90 only)	DW

4 LEISTUNG & STEUERUNG OUTPUT & CONTROL SORTIE & CONTRÔLE	
low output on/off	LO
low output DALI	LD
high output on/off	HO
high output DALI	HD
dynamic white DALI DT8	DW

5 GEHÄUSEFARBE HOUSING COLOUR COULEUR DU BOÎTIER	
silver RAL 9006	SI
white RAL 9016	WH
black RAL 9005	BL

6 DIFFUSOR DIFFUSER DIFFUSEUR	
opal	O
microprism	M
asymmetric	A

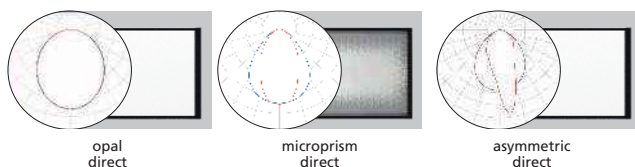
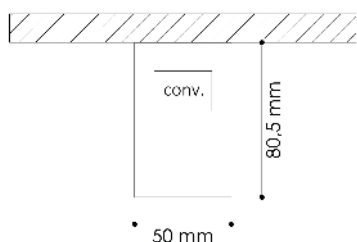

Size [mm]	opal direct		microprism direct		asymmetric direct		KG
	low output [lm] / [W]	high output [lm] / [W]	low output [lm] / [W]	high output [lm] / [W]	low output [lm] / [W]	high output [lm] / [W]	
614	909 / 8,8	1.731 / 16,3	826 / 8,8	1.581 / 16,3	925 / 8,8	1.771 / 16,3	1,5
974	1.455 / 13,0	2.770 / 25,0	1.321 / 13,0	2.530 / 25,0	1.480 / 13,0	2.834 / 25,0	2,3
1.214	1.818 / 16,3	3.463 / 30,0	1.652 / 16,3	3.162 / 30,0	1.850 / 16,3	3.541 / 30,0	2,9
1.454	2.182 / 18,5	4.156 / 35,8	1.982 / 18,5	3.794 / 35,8	2.220 / 18,5	4.249 / 35,8	3,5
1.694	2.546 / 21,2	4.848 / 41,1	2.313 / 21,2	4.427 / 41,1	2.591 / 21,2	4.958 / 41,1	4,1
1.934	2.911 / 23,7	5.541 / 46,3	2.642 / 23,7	5.059 / 46,3	2.959 / 23,7	5.666 / 46,3	4,6
2.174	3.273 / 26,6	6.233 / 52,0	2.974 / 26,6	5.692 / 52,0	3.331 / 26,6	6.375 / 52,0	5,2
2.414	3.635 / 29,2	6.926 / 57,3	3.304 / 29,2	6.324 / 57,3	3.700 / 29,2	7.083 / 57,3	5,8
2.894	4.364 / 34,3	8.311 / 69,6	3.964 / 34,3	7.589 / 69,6	4.440 / 34,3	8.500 / 69,6	7,0
3.134	4.728 / 36,9	9.004 / 75,5	4.295 / 36,9	8.221 / 75,5	4.810 / 36,9	9.208 / 75,5	7,5
3.856	5.821 / 47,4	11.082 / 92,6	5.284 / 47,4	10.118 / 92,6	5.918 / 47,4	11.332 / 92,6	9,3

Alle Lumenangaben für 4000K, CRI>80, Microprisma ohne Opalfolie  
 All lumen values for 4000K, CRI>80, microprism without opal foil  
 Toutes les données de lumens pour 4000K, CRI>80, microprisme sans feuille opale

# LINE50hex

ANBAULEUCHTE | SURFACE MOUNTED LUMINAIRE | LUMINAIRE EN SAILLIE

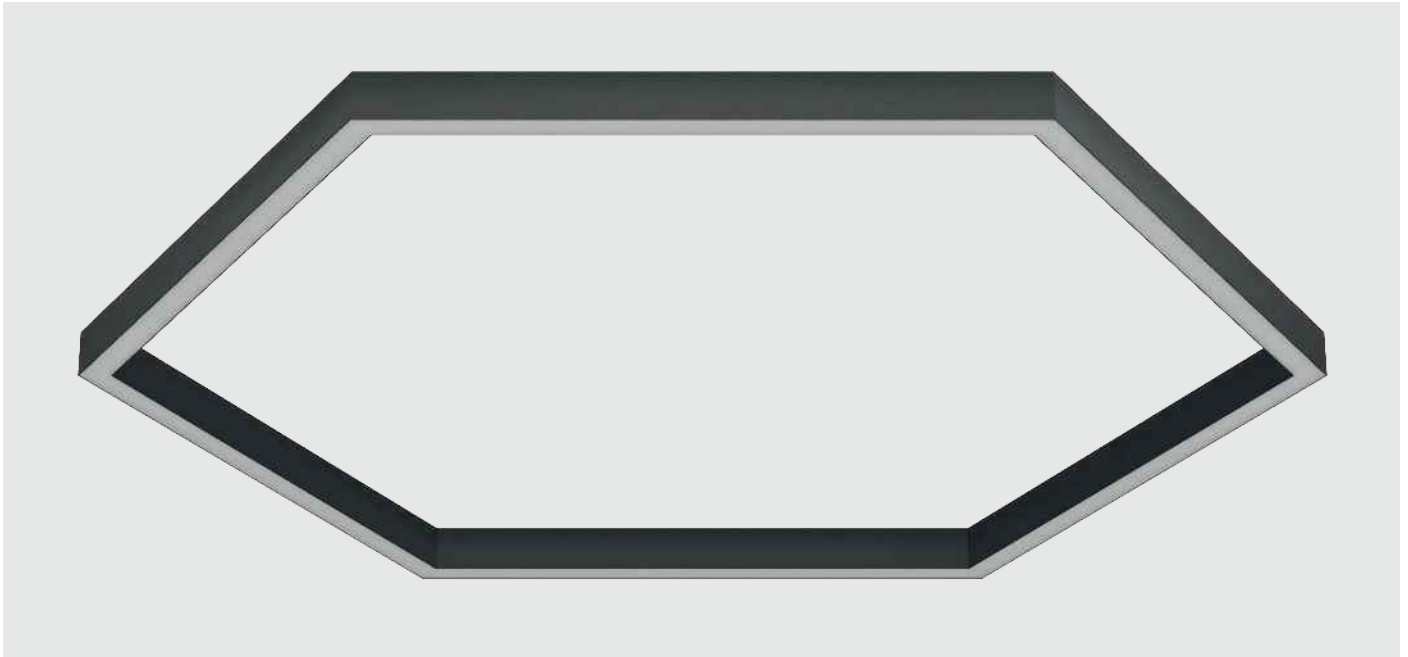

**LED-Anbauleuchte** direktstrahlend. Lichtkanal aus Aluminium-Strangpressprofil mit einer Breite von 50 mm. Leuchte in hexagonaler Form mit verschweißten Ecken – Lieferung der drei Standardgrößen komplett in einem Stück (DM 1306 mm), in zwei Teilen (DM 2028 mm) bzw. sechs gleich großen Teilen (DM 2988 mm). Oberfläche der Leuchte feinstruktur matt pulverbeschichtet ähnlich RAL 9016 weiß, RAL 9006 silber oder RAL 9005 schwarz – auf Anfrage in RAL nach Wahl. Diffusor wahlweise in PMMA opal oder PMMA klar mit eingeschobener mikroprismatischer Platte für eine reduzierte Leuchtdichte (UGR<19). Der LED-Treiber ist im Leuchtgehäuse integriert – wahlweise als on/off oder DALI-Variante. Farbtemperaturen 2700K, 3000K, 4000K oder dynamisch Weiß (2700K–6500K) – Farbwiedergabe CRI>80 oder CRI>90 – Mac Adam ≤3. Weitere Steuerungsoptionen oder Lichtfarben auf Anfrage erhältlich. Außerdem ist die Integration vieler Komponenten, wie beispielsweise Notlicht oder Sensortechnologie, sowie eine Vielzahl weiterer Optionen möglich.

**Surface mounted LED luminaire** with direct beam. Light channel made of extruded aluminium profile with a width of 50 mm. Luminaire in hexagonal shape with welded corners - delivery of the three standard sizes in one piece (DM 1306 mm), in two pieces (DM 2028 mm) or in six equally sized pieces (DM 2988 mm). Surface of the luminaire fine structure matt powder coated similar to RAL 9016 white, RAL 9006 silver or RAL 9005 black - on request in RAL of choice. Diffuser either in PMMA opal or PMMA clear with inserted microprismatic plate for reduced luminance (UGR<19). The LED driver is integrated in the luminaire housing - either as on/off or DALI version. Colour temperatures 2700K, 3000K, 4000K or dynamic white (2700K-6500K) - colour rendering CRI>80 or CRI>90 - Mac Adam ≤3. Further control options or light colours available on request. In addition, the integration of many components, such as emergency lighting or sensor technology, as well as a variety of other options is possible.

**Luminaire de surface LED en saillie** à éclairage direct. Canal lumineux en profilé d'aluminium extrudé d'une largeur de 50 mm. Luminaire de forme hexagonale avec coins soudés - livraison des trois tailles standard complètes en une pièce (DM 1306 mm), en deux pièces (DM 2028 mm) ou en six pièces de taille identique (DM 2988 mm). Surface du luminaire à structure fine matte revêtue par poudre similaire à RAL 9016 blanc, RAL 9006 argent ou RAL 9005 noir - sur demande en RAL au choix. Diffuseur au choix en PMMA opale ou en PMMA transparent avec plaque microprismatique insérée pour un éblouissement réduit (UGR<19). Le pilote LED est intégré dans le boîtier du luminaire - au choix sous forme de variante on/off ou DALI. Températures de couleur 2700K, 3000K, 4000K ou blanc dynamique (2700K-6500K) - Rendu des couleurs CRI>80 ou CRI>90 - Mac Adam ≤3. Autres options de commande ou couleurs de lumière disponibles sur demande. En outre, l'intégration de nombreux composants, tels que l'éclairage de secours ou la technologie des capteurs, une multitude d'autres options sont possibles.

## ÜBERSICHT | OVERVIEW | VUE D'ENSEMBLE

### TECHNICAL DATA

2700K / 3000K / 4000K / 2700-6500K

CRI>80 / CRI>90

MacAdam ≤ 3

up to 130 lm/W, up to 2.939 lm/m

on-off / DALI

direct

opal / microprism (UGR <19)

L80 B10 50.000h

### HOUSING COLOUR

schwarz | black | noir  
RAL 9005

silber | silver | argent  
RAL 9006

weiß | white | blanc  
RAL 9016



RAL colour of your choice



Integration of 3-phase-track



Integration of Multisensor



Welded mitre cuts



Integration of emergency light



Integration of GLOWmini/ GLOWsmall series



Contact us for more options...

**ANBAULEUCHE „LINE50hex“**  
 SURFACE MOUNTED LUMINAIRE “LINE50hex”  
 LUMINAIRE EN SAILLIE « LINE50hex »

Bestellbeispiel | Example order | Exemple de commande  
 2.988 mm, CRI>90, 4000K, **direct**, low output on/off, black, microprism

**LH50A-299401-LOBLM**

1 2 3 4 5 6

1 GRÖSSE SIZE TAILLE	
1.306 mm	<b>13</b>
2.028 mm	<b>20</b>
2.988 mm	<b>29</b>

2 FARBWIEDERGABE COLOUR RENDERING RENDU DES COULEURS	
CRI>80	<b>8</b>
CRI>90	<b>9</b>

3 FARBTEMPERATUR COLOUR TEMPERATURE TEMPÉRATURE DE COULEUR	
2700K (CRI>90 only)	<b>27</b>
3000K	<b>30</b>
4000K	<b>40</b>
2700-6500K (CRI>90 only)	<b>DW</b>

4 LEISTUNG & STEUERUNG OUTPUT & CONTROL SORTIE & CONTRÔLE	
low output on/off	<b>LO</b>
low output DALI	<b>LD</b>
high output on/off	<b>HO</b>
high output DALI	<b>HD</b>
dynamic white DALI DT8	<b>DW</b>

5 GEHÄUSEFARBE HOUSING COLOUR COULEUR DU BOÎTIER	
silver RAL 9006	<b>SI</b>
white RAL 9016	<b>WH</b>
black RAL 9005	<b>BL</b>

6 DIFFUSOR DIFFUSER DIFFUSEUR	
opal	<b>O</b>
microprism	<b>M</b>

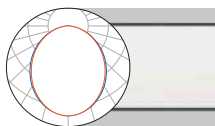
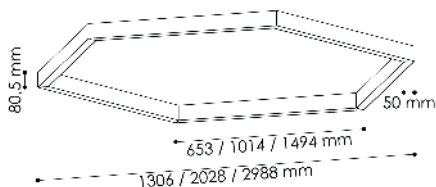

opal direct

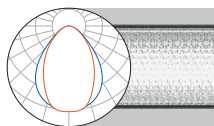

microprism direct

Size [mm]	opal direct		microprism direct		KG
	low output [lm] / [W]	high output [lm] / [W]	low output [lm] / [W]	high output [lm] / [W]	
1.306	5.454 / 44,9	10.389 / 87,7	4.956 / 44,9	9.486 / 87,7	9,0
2.028	8.730 / 67,0	16.619 / 134,8	7.926 / 67,0	15.180 / 134,8	13,8
2.988	13.092 / 99,8	24.935 / 206,0	11.892 / 99,8	22.764 / 206,0	21,0

Alle Lumenangaben für 4000K, CRI>80, Microprisma ohne Opalfolie

All lumen values for 4000K, CRI>80, microprism without opal foil

Toutes les données de lumens pour 4000K, CRI>80, microprisme sans feuille opale



# LINE50HEXmute

ANBAULEUCHE | SURFACE MOUNTED LUMINAIRE | LUMINAIRE EN SAILLIE



**LED-Anbauleuchte** direktstrahlend. Lichtkanal aus Aluminium-Strangpressprofil mit einer Breite von 50 mm. Leuchte in hexagonaler Form mit verschweißten Ecken – Lieferung komplett in einem Stück (DM 1306 mm). Oberfläche der Leuchte feinstruktur matt pulverbeschichtet ähnlich RAL 9016 weiß, RAL 9006 silber oder RAL 9005 schwarz – auf Anfrage in RAL nach Wahl. Akustikelemente aus recyceltem PET in schwarz, hellgrau meliert, anthrazit meliert, burgunderrot oder olivgrün auswählbar. Diffusor wahlweise in PMMA opal oder PMMA klar mit eingeschobener mikroprismatischer Platte für eine reduzierte Leuchtdichte (UGR<19). Der LED-Treiber ist im Leuchtgehäuse integriert – wahlweise als on/off oder DALI-Variante. Farbtemperaturen 2700K, 3000K, 4000K oder dynamisch Weiß (2700K–6500K) – Farbwiedergabe CRI>80 oder CRI>90 – Mac Adam ≤3. Weitere Steuerungsoptionen oder Lichtfarben auf Anfrage erhältlich. Außerdem ist die Integration vieler Komponenten, wie beispielsweise Notlicht oder Sensortechnologie, sowie eine Vielzahl weiterer Optionen möglich.

**Surface mounted LED luminaire** with direct beam. Light channel made of extruded aluminium profile with a width of 50 mm. Luminaire in hexagonal form with welded corners – delivery in one piece (DM 1306 mm). Surface of the luminaire fine structure matt powder coated similar to RAL 9016 white, RAL 9006 silver or RAL 9005 black – on request in RAL of choice. Acoustic elements available in black, light grey mottled, anthracite mottled, burgundy red or olive green. Diffuser either in PMMA opal or PMMA clear with inserted microprismatic plate for reduced luminance (UGR<19). The LED driver is integrated in the luminaire housing – either as on/off or DALI version. Colour temperatures 2700K, 3000K, 4000K or dynamic white (2700K-6500K) – colour rendering CRI>80 or CRI>90 - Mac Adam ≤3. Further control options or light colours available on request. In addition, the integration of many components, such as emergency lighting or sensor technology, as well as a variety of other options is possible.

**Luminaire de surface LED en saillie** à éclairage direct. Canal lumineux en profilé d'aluminium extrudé d'une largeur de 50 mm. Luminaire de forme hexagonale avec coins soudés - livraison en une pièce (DM 1306 mm). Surface du luminaire à structure fine matte revêtue par poudre similaire à RAL 9016 blanc, RAL 9006 argent ou RAL 9005 noir - sur demande en RAL au choix. Éléments acoustiques en noir, gris clair chiné, anthracite chiné, rouge bordeaux ou vert olive au choix. Diffuseur au choix en PMMA opale ou en PMMA transparent avec plaque microprismatique insérée pour un éblouissement réduit (UGR<19). Le pilote LED est intégré dans le boîtier du luminaire - au choix sous forme de variante on/off ou DALI. Températures de couleur 2700K, 3000K, 4000K ou blanc dynamique (2700K-6500K) - Rendu des couleurs CRI>80 ou CRI>90 - Mac Adam ≤3. Autres options de commande ou couleurs de lumière disponibles sur demande. En outre, l'intégration de nombreux composants, tels que l'éclairage de secours ou la technologie des capteurs, une multitude d'autres options sont possibles.

## ÜBERSICHT | OVERVIEW | VUE D'ENSEMBLE

### TECHNICAL DATA

2700K / 3000K / 4000K / 2700-6500K

CRI>80 / CRI>90

MacAdam ≤ 3

up to 122 lm/W, up to 2766 lm/m

on-off / DALI

direct

opal / microprism (UGR <19)

L80 B10 50.000h

acoustic material - fire classification: B-s2, d0 (EN13501-1:3018)



RAL colour of your choice



Integration of 3-phase-track



Integration of Multisensor



Welded mitre cuts



Integration of emergency light



Integration of GLOWmini/ GLOWsmall series



Contact us for more options...

### HOUSING COLOUR

schwarz | black | noir  
RAL 9005



silber | silver | argent  
RAL 9006



weiß | white | blanc  
RAL 9016



### COLOUR ACOUSTIC PANEL

schwarz | black | noir



burgunderrot | burgundy red | rouge bourgogne



hellgrau meliert | light grey mottled| gris clair chiné



olivgrün | olive green | vert olive



anthrazit meliert | anthracite mottled| anthracite chiné



**ANBAULEUCHTE „LINE50HEXmute“**  
 SURFACE MOUNTED LUMINAIRE “LINE50HEXmute”  
 LUMINAIRE EN SAILLIE « LINE50HEXmute »

Bestellbeispiel | Example order | Exemple de commande  
 1.306 mm, CRI90, 4000K, **direct**, low output on/off, black, olive, microprism

**LH5MA-139401-LOBOM**

1 2 3 4 5 6

**1** FARBWIEDERGABE  
COLOUR RENDERING  
RENDU DES COULEURS

CRI>80	<b>8</b>
CRI>90	<b>9</b>

**2** FARBTEMPERATUR  
COLOUR TEMPERATURE  
TEMPÉRATURE DE COULEUR

2700K (CRI>90 only)	<b>27</b>
3000K	<b>30</b>
4000K	<b>40</b>
2700-6500K (CRI>90 only)	<b>DW</b>

**3** LEISTUNG & STEUERUNG  
OUTPUT & CONTROL  
SORTIE & CONTRÔLE

low output on/off	<b>LO</b>
low output DALI	<b>LD</b>
high output on/off	<b>HO</b>
high output DALI	<b>HD</b>
dynamic white DALI DT8	<b>DW</b>

**4** GEHÄUSEFARBE  
HOUSING COLOUR  
COULEUR DU BOÎTIER

silver RAL 9006	<b>S</b>
white RAL 9016	<b>W</b>
black RAL 9005	<b>B</b>

**5** FARBE AKUSTIKPLATTE  
COLOUR ACOUSTIC PANEL  
COULEUR PANNEAU ACOUSTIQUE

black	<b>B</b>
light grey mottled	<b>S</b>
anthracite mottled	<b>A</b>
burgundy red	<b>R</b>
olive green	<b>O</b>

**6** DIFFUSOR  
DIFFUSER  
DIFFUSEUR

opal	<b>O</b>
microprism	<b>M</b>

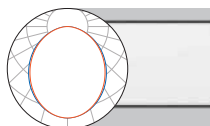
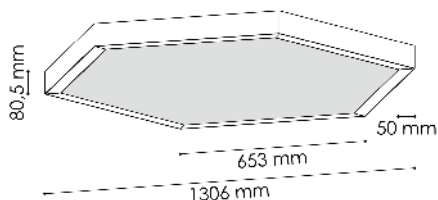

opal  
direct

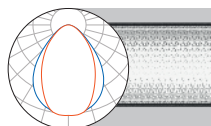

microprism  
direct

Size [mm]	low output [lm] / [W]	high output [lm] / [W]	low output [lm] / [W]	high output [lm] / [W]	 [kg]
1.306	5.454 / 44,9	10.389 / 87,7	4.956 / 44,9	9.486 / 87,7	12,9

Alle Lumenangaben für 4000K, CRI>80, Microprisma ohne Opalfolie  
 All lumen values for 4000K, CRI>80, microprism without opal foil  
 Toutes les données de lumens pour 4000K, CRI>80, microprisme sans feuille opale

# LINE50quad

ANBAULEUCHTE | SURFACE MOUNTED LUMINAIRE | LUMINAIRE EN SAILLIE



**LED-Anbauleuchte** direktstrahlend. Lichtkanal aus Aluminium-Strangpressprofil mit einer Breite von 50 mm. Leuchte in quadratischer Form mit verschweißten Ecken – Lieferung der drei Standardgrößen komplett in einem Stück (660, 1020 mm) bzw. in zwei Teilen (1500 mm). Oberfläche der Leuchte feinstruktur matt pulverbeschichtet ähnlich RAL 9016 weiß, RAL 9006 silber oder RAL 9005 schwarz – auf Anfrage in RAL nach Wahl. Diffusor wahlweise in PMMA opal oder PMMA klar mit eingeschobener mikroprismatischer Platte für eine reduzierte Leuchtdichte (UGR<19). Der LED-Treiber ist im Leuchtengehäuse integriert – wahlweise als on/off oder DALI-Variante. Farbtemperaturen 2700K, 3000K, 4000K oder dynamisch Weiß (2700K–6500K) – Farbwiedergabe CRI>80 oder CRI>90 – Mac Adam ≤3. Weitere Steuerungsoptionen oder Lichtfarben auf Anfrage erhältlich. Außerdem ist die Integration vieler Komponenten, wie beispielsweise Notlicht oder Sensortechnologie, sowie eine Vielzahl weiterer Optionen möglich.

**Surface mounted LED luminaire** with direct beam. Light channel made of extruded aluminium profile with a width of 50 mm. Luminaire in square shape with welded corners - delivery of the three standard sizes in one piece (660, 1020 mm) or in two pieces (1500 mm). Surface of the luminaire fine structure matt powder coated similar to RAL 9016 white, RAL 9006 silver or RAL 9005 black - on request in RAL of choice. Diffuser either in PMMA opal or PMMA clear with inserted microprismatic plate for reduced luminance (UGR<19). The LED driver is integrated in the luminaire housing - either as on/off or DALI version. Colour temperatures 2700K, 3000K, 4000K or dynamic white (2700K-6500K) - colour rendering CRI>80 or CRI>90 - Mac Adam ≤3. Further control options or light colours available on request. In addition, the integration of many components, such as emergency lighting or sensor technology, as well as a variety of other options is possible.

**Luminaire de surface LED en saillie** à éclairage direct. Canal lumineux en profilé d'aluminium extrudé d'une largeur de 50 mm. Luminaire de forme carrée avec coins soudés - livraison des trois tailles standard complètes en une pièce (660, 1020 mm) ou en deux pièces (1500 mm). Surface du luminaire à structure fine matte revêtue par poudre similaire à RAL 9016 blanc, RAL 9006 argent ou RAL 9005 noir - sur demande en RAL au choix. Diffuseur au choix en PMMA opale ou en PMMA transparent avec plaque microprismatique insérée pour un éblouissement réduit (UGR<19). Le pilote LED est intégré dans le boîtier du luminaire - au choix sous forme de variante on/off ou DALI. Températures de couleur 2700K, 3000K, 4000K ou blanc dynamique (2700K-6500K) - Rendu des couleurs CRI>80 ou CRI>90 - Mac Adam ≤3. Autres options de commande ou couleurs de lumière disponibles sur demande. En outre, l'intégration de nombreux composants, tels que l'éclairage de secours ou la technologie des capteurs, une multitude d'autres options sont possibles.

## ÜBERSICHT | OVERVIEW | VUE D'ENSEMBLE

### TECHNICAL DATA

2700K / 3000K / 4000K / 2700-6500K

CRI>80 / CRI>90

MacAdam ≤ 3

up to 130 lm/W, up to 2.939 lm/m

on-off / DALI

direct

opal / microprism (UGR <19)

L80 B10 50.000h

### HOUSING COLOUR

schwarz | black | noir  
RAL 9005

silber | silver | argent  
RAL 9006

weiß | white | blanc  
RAL 9016



RAL colour of your choice



Integration of 3-phase-track



Integration of Multisensor



Welded mitre cuts



Integration of emergency light



Integration of GLOWmini/ GLOWsmall series



Contact us for more options...

**ANBAULEUCHTE „LINE50quad“**  
 SURFACE MOUNTED LUMINAIRE “LINE50quad”  
 LUMINAIRE EN SAILLIE « LINE50quad »

Bestellbeispiel | Example order | Exemple de commande  
 660 x 660 mm, CRI>90, 4000K, **direct**, low output on/off, black, microprism

**LQ50A-069401-LOBLM**

1 2 3 4 5 6

**1 GRÖSSE**  
 SIZE  
 TAILLE

660 x 660 mm	<b>06</b>
1.020 x 1.020 mm	<b>10</b>
1.500 x 1.500 mm	<b>15</b>

**2 FARBWIEDERGABE**  
 COLOUR RENDERING  
 RENDU DES COULEURS

CRI>80	<b>8</b>
CRI>90	<b>9</b>

**3 FARBTEMPERATUR**  
 COLOUR TEMPERATURE  
 TEMPÉRATURE DE COULEUR

2700K (CRI>90 only)	<b>27</b>
3000K	<b>30</b>
4000K	<b>40</b>
2700-6500K (CRI>90 only)	<b>DW</b>

**4 LEISTUNG & STEUERUNG**  
 OUTPUT & CONTROL  
 SORTIE & CONTRÔLE

low output on/off	<b>LO</b>
low output DALI	<b>LD</b>
high output on/off	<b>HO</b>
high output DALI	<b>HD</b>
dynamic white DALI DT8	<b>DW</b>

**5 GEHÄUSEFARBE**  
 HOUSING COLOUR  
 COULEUR DU BOÎTIER

silver RAL 9006	<b>SI</b>
white RAL 9016	<b>WH</b>
black RAL 9005	<b>BL</b>

**6 DIFFUSOR**  
 DIFFUSER  
 DIFFUSEUR

opal	<b>O</b>
microprism	<b>M</b>

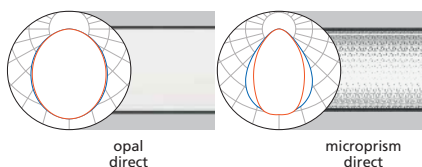
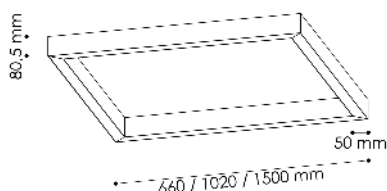

Size [mm]	opal direct		microprism direct		KE
	low output [lm] / [W]	high output [lm] / [W]	low output [lm] / [W]	high output [lm] / [W]	
□ 660	3.637 / 29,1	6.926 / 57,2	3.304 / 29,1	6.324 / 57,2	6,0
□ 1.020	5.821 / 44,6	11.080 / 91,7	5.284 / 44,6	10.120 / 91,7	9,2
□ 1.500	8.728 / 67,0	16.624 / 134,8	7.928 / 67,0	15.176 / 134,8	14,0

Alle Lumenangaben für 4000K, CRI>80, Microprisma ohne Opalfolie  
 All lumen values for 4000K, CRI>80, microprism without opal foil  
 Toutes les données de lumens pour 4000K, CRI>80, microprisme sans feuille opale

# LINE50QUADmute

ANBAULEUCHE | SURFACE MOUNTED LUMINAIRE | LUMINAIRE EN SAILLIE

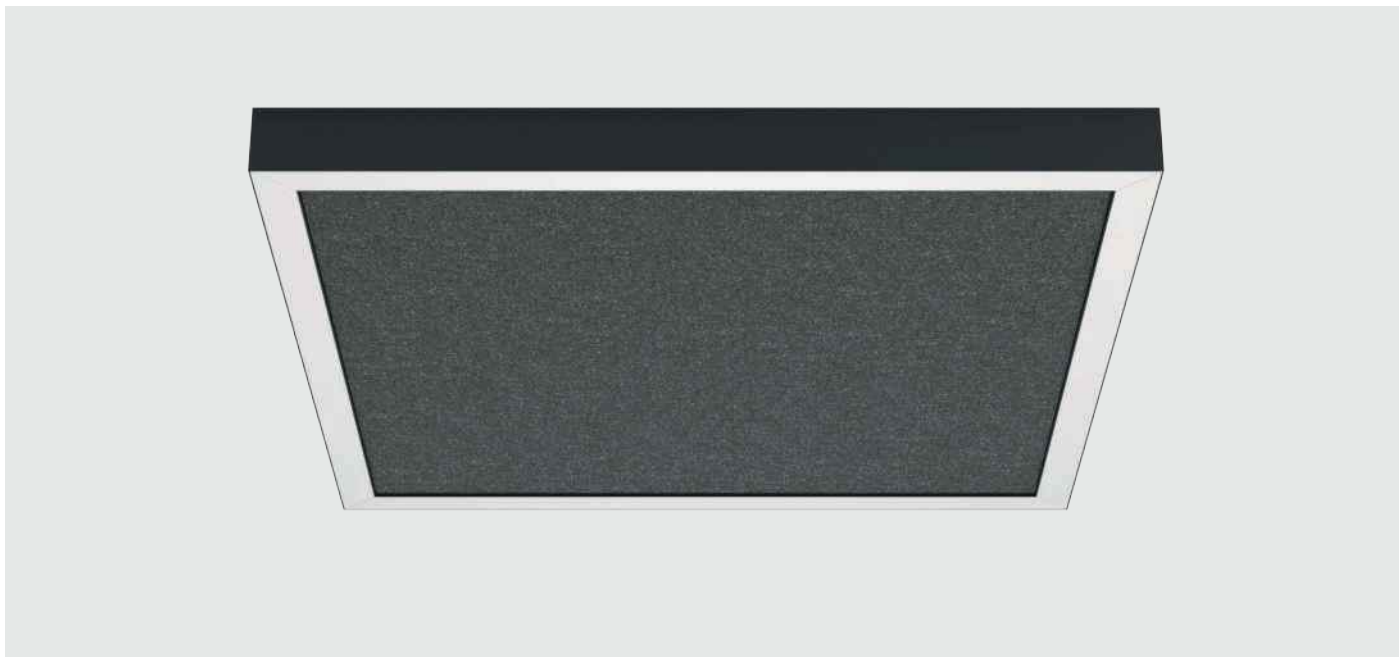























**LED-Anbauleuchte** direktstrahlend. Lichtkanal aus Aluminium-Strangpressprofil mit einer Breite von 50 mm. Leuchte in quadratischer Form mit verschweißten Ecken – Lieferung der zwei Standardgrößen komplett in einem Stück (660, 1020 mm). Oberfläche der Leuchte feinstruktur matt pulverbeschichtet ähnlich RAL 9016 weiß, RAL 9006 silber oder RAL 9005 schwarz – auf Anfrage in RAL nach Wahl. Akustikelemente aus recyceltem PET in schwarz, hellgrau meliert, anthrazit meliert, burgunderrot oder olivgrün auswählbar. Diffusor wahlweise in PMMA opal oder PMMA klar mit eingeschobener mikroprismatischer Platte für eine reduzierte Leuchtdichte (UGR<19). Der LED-Treiber ist im Leuchtgehäuse integriert – wahlweise als on/off oder DALI-Variante – Farbtemperaturen 2700K, 3000K, 4000K oder dynamisch Weiß (2700K– 6500K) – Farbwiedergabe CRI>80 oder CRI>90 – Mac Adam ≤3. Weitere Steuerungsoptionen oder Lichtfarben auf Anfrage erhältlich. Außerdem ist die Integration vieler Komponenten, wie beispielsweise Notlicht oder Sensortechnologie, sowie eine Vielzahl weiterer Optionen möglich.

**Surface mounted LED luminaire** with direct beam. Light channel made of extruded aluminium profile with a width of 50 mm. Luminaire in square shape with welded corners – delivery of the two standard sizes in one piece (660, 1020 mm). Surface of the luminaire fine structure matt powder coated similar to RAL 9016 white, RAL 9006 silver or RAL 9005 black – on request in RAL of choice. Acoustic elements made of recycled PET available in black, light grey mottled, anthracite mottled, burgundy red or olive green. Diffuser either in PMMA opal or PMMA clear with inserted microprismatic plate for reduced luminance (UGR<19). The LED driver is integrated in the luminaire housing – either as on/off or DALI version – colour temperatures 2700K, 3000K, 4000K or dynamic white (2700K-6500K) – colour rendering CRI>80 or CRI>90 – Mac Adam ≤3. Further control options or light colours available on request. In addition, the integration of many components, such as emergency lighting or sensor technology, as well as a variety of other options is possible.

**Luminaire de surface LED en saillie** à éclairage direct. Canal lumineux en profilé d'aluminium extrudé d'une largeur de 50 mm. Luminaire de forme carrée avec coins soudés – livraison des deux tailles standard complètes en une pièce (660, 1020 mm). Surface du luminaire à structure entièrement en une seule pièce. Surface du luminaire à structure fine matte revêtue par poudre similaire à RAL 9016 blanc, RAL 9006 argent ou RAL 9005 noir – sur demande en RAL au choix. Éléments acoustiques fabriqué en PET recyclé en noir, gris clair chiné, anthracite chiné, rouge bordeaux ou vert olive au choix. Diffuseur au choix en PMMA opale ou en PMMA transparent avec plaque microprismatique insérée pour un éblouissement réduit (UGR<19). Le pilote LED est intégré dans le boîtier du luminaire – au choix sous forme de variante on/off ou DALI – températures de couleur 2700K, 3000K, 4000K ou blanc dynamique (2700K-6500K) – rendu des couleurs CRI>80 ou CRI>90 – Mac Adam ≤3. Autres options de commande ou couleurs de lumière disponibles sur demande. En outre, l'intégration de nombreux composants, tels que l'éclairage de secours ou la technologie des capteurs, une multitude d'autres options sont possibles.

## ÜBERSICHT | OVERVIEW | VUE D'ENSEMBLE

TECHNICAL DATA	
2700K / 3000K / 4000K / 2700-6500K	
CRI>80 / CRI>90	
MacAdam ≤ 3	
up to 131 lm/W, up to 2766 lm/m	
on-off / DALI	
direct	
opal / microprism (UGR <19)	
L80 B10 50.000h	
acoustic material - fire classification: B-s2, d0 (EN13501-1:3018)	
HOUSING COLOUR	
schwarz   black   noir RAL 9005	
silber   silver   argent RAL 9006	
weiß   white   blanc RAL 9016	

							
							
RAL colour of your choice	Integration of 3-phase-track	Integration of Multisensor	Welded mitre cuts	Integration of emergency light	Integration of GLOWmini/ GLOWsmall series	Contact us for more options...	
COLOUR ACOUSTIC PANEL							
schwarz   black   noir		burgunderrot   burgundy red   rouge bourgogne					
hellgrau meliert   light grey mottled  gris clair chiné		olivgrün   olive green   vert olive					
anthrazit meliert  anthracite mottled  anthracite chiné							

**ANBAULEUCHTE „LINE50QUADmute“**  
 SURFACE MOUNTED LUMINAIRE “LINE50QUADmute”  
 LUMINAIRE EN SAILLIE « LINE50QUADmute »

Bestellbeispiel | Example order | Exemple de commande  
 660 x 660 mm, CRI90, 4000K, **direct**, low output on/off, black, olive, microprism

**LQ5MA-069401-LOBOM**

1 2 3 4 5 6 7

**1 GRÖSSE**  
 SIZE  
 TAILLE

660 x 660 mm	<b>06</b>
1.020 x 1.020 mm	<b>10</b>

**2 FARBWIEDERGABE**  
 COLOUR RENDERING  
 RENDU DES COULEURS

CRI>80	<b>8</b>
CRI>90	<b>9</b>

**3 FARBTEMPERATUR**  
 COLOUR TEMPERATURE  
 TEMPÉRATURE DE COULEUR

2700K (CRI>90 only)	<b>27</b>
3000K	<b>30</b>
4000K	<b>40</b>
2700-6500K (CRI>90 only)	<b>DW</b>

**4 LEISTUNG & STEUERUNG**  
 OUTPUT & CONTROL  
 SORTIE & CONTRÔLE

low output on/off	<b>LO</b>
low output DALI	<b>LD</b>
high output on/off	<b>HO</b>
high output DALI	<b>HD</b>
dynamic white DALI DT8	<b>DW</b>

**5 GEHÄUSEFARBE**  
 HOUSING COLOUR  
 COULEUR DU BOÎTIER

silver RAL 9006	<b>S</b>
white RAL 9016	<b>W</b>
black RAL 9005	<b>B</b>

**6 FARBE AKUSTIKPLATTE**  
 COLOUR ACOUSTIC PANEL  
 COULEUR PANNEAU ACOUSTIQUE

black	<b>B</b>
light grey mottled	<b>S</b>
anthracite mottled	<b>A</b>
burgundy red	<b>R</b>
olive green	<b>O</b>

**7 DIFFUSOR**  
 DIFFUSER  
 DIFFUSEUR

opal	<b>O</b>
microprism	<b>M</b>

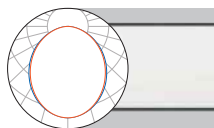
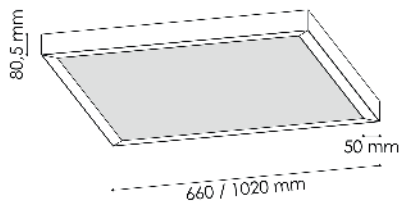

opal  
direct

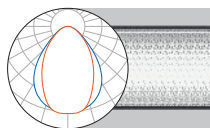

microprism  
direct

Size [mm]	low output [lm] / [W]	high output [lm] / [W]	low output [lm] / [W]	high output [lm] / [W]	
□ 660	3.637 / 29,1	6.926 / 57,2	3.304 / 29,1	6.324 / 57,2	7,3
□ 1.020	5.821 / 44,6	11.080 / 91,7	5.284 / 44,6	10.120 / 91,7	12,7

Alle Lumenangaben für 4000K, CRI>80, Microprisma ohne Opalfolie  
 All lumen values for 4000K, CRI>80, microprism without opal foil  
 Toutes les données de lumens pour 4000K, CRI>80, microprisme sans feuille opale



# LINE50splash

ANBAULEUCHE | SURFACE MOUNTED LUMINAIRE | LUMINAIRE EN SAILLIE



**LED-Anbauleuchte** mit erhöhter Schutzart IP54 direktstrahlend. Lichtkanal aus Aluminium-Strangpressprofil mit einer Breite von 50 mm. Oberfläche der Leuchte feinstruktur matt pulverbeschichtet ähnlich RAL 9016 weiß, RAL 9006 silber oder RAL 9005 schwarz – auf Anfrage in RAL nach Wahl. Diffusor wahlweise in PMMA opal, PMMA klar mit eingeschobener asymmetrischer Folie oder PMMA klar mit eingeschobener mikroprismatischer Platte für eine reduzierte Leuchtdichte (UGR<19). Der LED-Treiber ist im Leuchtgehäuse integriert – wahlweise als on/off oder DALI-Variante – Farbtemperaturen 2700K, 3000K, 4000K oder dynamisch Weiß (2700K–6500K) – Farbwiedergabe CRI>80 oder CRI>90 – Mac Adam ≤3. Weitere Steuerungsoptionen oder Lichtfarben auf Anfrage erhältlich. Außerdem ist die Integration vieler Komponenten, wie beispielsweise Notlicht, sowie eine Vielzahl weiterer Optionen möglich.

**Surface mounted LED luminaire** with increased protection rating IP54 and direct beam. Light channel made of extruded aluminium profile with a width of 50 mm. Surface of the luminaire fine structure matt powder coated similar to RAL 9016 white, RAL 9006 silver or RAL 9005 black - on request in RAL of choice. Diffuser either in PMMA opal, PMMA clear with inserted asymmetric foil or PMMA clear with inserted microprismatic plate for reduced luminance (UGR<19). The LED driver is integrated in the luminaire housing - either as on/off or DALI version - colour temperatures 2700K, 3000K, 4000K or dynamic white (2700K-6500K) - colour rendering CRI>80 or CRI>90 - Mac Adam ≤3. Further control options or light colours available on request. In addition, the integration of many components, such as emergency lighting, as well as a variety of other options is possible.

**Luminaire de surface LED en saillie** avec un degré de protection élevé IP54 à éclairage direct. Canal lumineux en profilé d'aluminium extrudé d'une largeur de 50 mm. Surface du luminaire à structure fine, revêtement par poudre mat similaire à RAL 9016 blanc, RAL 9006 argent ou RAL 9005 noir - sur demande en RAL au choix. Diffuseur au choix en PMMA opale, PMMA transparent avec feuille asymétrique insérée ou PMMA transparent avec plaque microprismatique insérée pour un éblouissement réduit (UGR<19). Le pilote LED est intégré dans le boîtier du luminaire - au choix sous forme de variante on/off ou DALI - températures de couleur 2700K, 3000K, 4000K ou blanc dynamique (2700K-6500K) - rendu des couleurs CRI>80 ou CRI>90 - Mac Adam ≤3. Autres options de commande ou couleurs de lumière disponibles sur demande. En outre, l'intégration de nombreux composants, tels que l'éclairage de secours, une multitude d'autres options sont possibles.

## ÜBERSICHT | OVERVIEW | VUE D'ENSEMBLE

### TECHNICAL DATA

2700K / 3000K / 4000K / 2700-6500K

CRI>80 / CRI>90

MacAdam ≤ 3

up to 130 lm/W, up to 2.930 lm/m

on-off / DALI

direct

opal / microprism (UGR <19) / asymmetric

L80 B10 50.000h

### HOUSING COLOUR

schwarz | black | noir  
RAL 9005

silber | silver | argent  
RAL 9006

weiß | white | blanc  
RAL 9016



RAL colour of your choice



Integration of emergency light



Contact us for more options...

**ANBAULEUCHTE „LINE50splash“**  
 SURFACE MOUNTED LUMINAIRE “LINE50splash”  
 LUMINAIRE EN SAILLIE « LINE50splash »

Bestellbeispiel | Example order | Exemple de commande  
 3.145 mm, CRI90, 4000K, **direct**, low output on/off, black, microprism

**LS50A-319401-LOBLM**

1 2 3 4 5 6

1 LÄNGE LENGTH LONGEUR	
625 mm	06
985 mm	09
1.225 mm	12
1.465 mm	14
1.705 mm	17
1.945 mm	19
2.185 mm	21
2.425 mm	24
2.905 mm	29
3.145 mm	31
3.867 mm	38

2 FARBWIEDERGABE COLOUR RENDERING RENDU DES COULEURS	
CRI>80	8
CRI>90	9

3 FARBTEMPERATUR COLOUR TEMPERATURE TEMPÉRATURE DE COULEUR	
2700K (CRI>90 only)	27
3000K	30
4000K	40
2700-6500K (CRI>90 only)	DW

4 LEISTUNG & STEUERUNG OUTPUT & CONTROL SORTIE & CONTRÔLE	
low output on/off	LO
low output DALI	LD
high output on/off	HO
high output DALI	HD
dynamic white DALI DT8	DW

5 GEHÄUSEFARBE HOUSING COLOUR COULEUR DU BOÎTIER	
silver RAL 9006	SI
white RAL 9016	WH
black RAL 9005	BL

6 DIFFUSOR DIFFUSER DIFFUSEUR	
opal	O
microprism	M
asymmetric	A

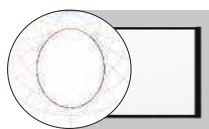
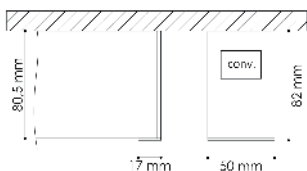

opal  
direct

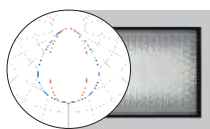

microprism  
direct



asymmetric  
direct

Size [mm]	low output [lm] / [W]	high output [lm] / [W]	low output [lm] / [W]	high output [lm] / [W]	low output [lm] / [W]	high output [lm] / [W]	kg
625	908 / 8,8	1.731 / 16,3	826 / 8,8	1.731 / 16,3	867 / 8,8	1.660 / 16,3	1,9
985	1.455 / 13,0	2.770 / 25,0	1.321 / 13,0	2.770 / 25,0	1.387 / 13,0	2.656 / 25,0	2,7
1.225	1.818 / 16,3	3.463 / 30,0	1.652 / 16,3	3.162 / 30,0	1.735 / 16,3	3.320 / 30,0	3,3
1.465	2.182 / 18,5	4.156 / 35,8	1.982 / 18,5	3.794 / 35,8	2.081 / 18,5	3.984 / 35,8	3,9
1.705	2.546 / 21,2	4.848 / 41,1	2.313 / 21,2	4.427 / 41,1	2.429 / 21,2	4.648 / 41,1	4,5
1.945	2.911 / 23,7	5.541 / 46,3	2.642 / 23,7	5.059 / 46,3	2.774 / 23,7	5.312 / 46,3	5,0
2.185	3.273 / 26,6	6.233 / 52,0	2.974 / 26,6	5.692 / 52,0	3.123 / 26,6	5.977 / 52,0	5,6
2.425	3.635 / 29,2	6.926 / 57,3	3.304 / 29,2	6.324 / 57,3	3.469 / 29,2	6.640 / 57,3	6,2
2.905	4.364 / 34,3	8.311 / 69,6	3.964 / 34,3	7.589 / 69,6	4.162 / 34,3	7.968 / 69,6	7,4
3.145	4.728 / 36,9	9.004 / 75,5	4.295 / 36,9	8.221 / 75,5	4.510 / 36,9	8.632 / 75,5	7,9
3.867	5.821 / 47,4	11.082 / 92,6	5.284 / 47,4	10.118 / 92,6	5.548 / 47,4	10.624 / 92,6	9,7

Alle Lumenangaben für 4000K, CRI>80, Microprisma ohne Opalfolie  
 All lumen values for 4000K, CRI>80, microprism without opal foil  
 Toutes les données de lumens pour 4000K, CRI>80, microprisme sans feuille opale

# officeLINE50

ANBAULEUCHTE | SURFACE MOUNTED LUMINAIRE | LUMINAIRE EN SAILLIE

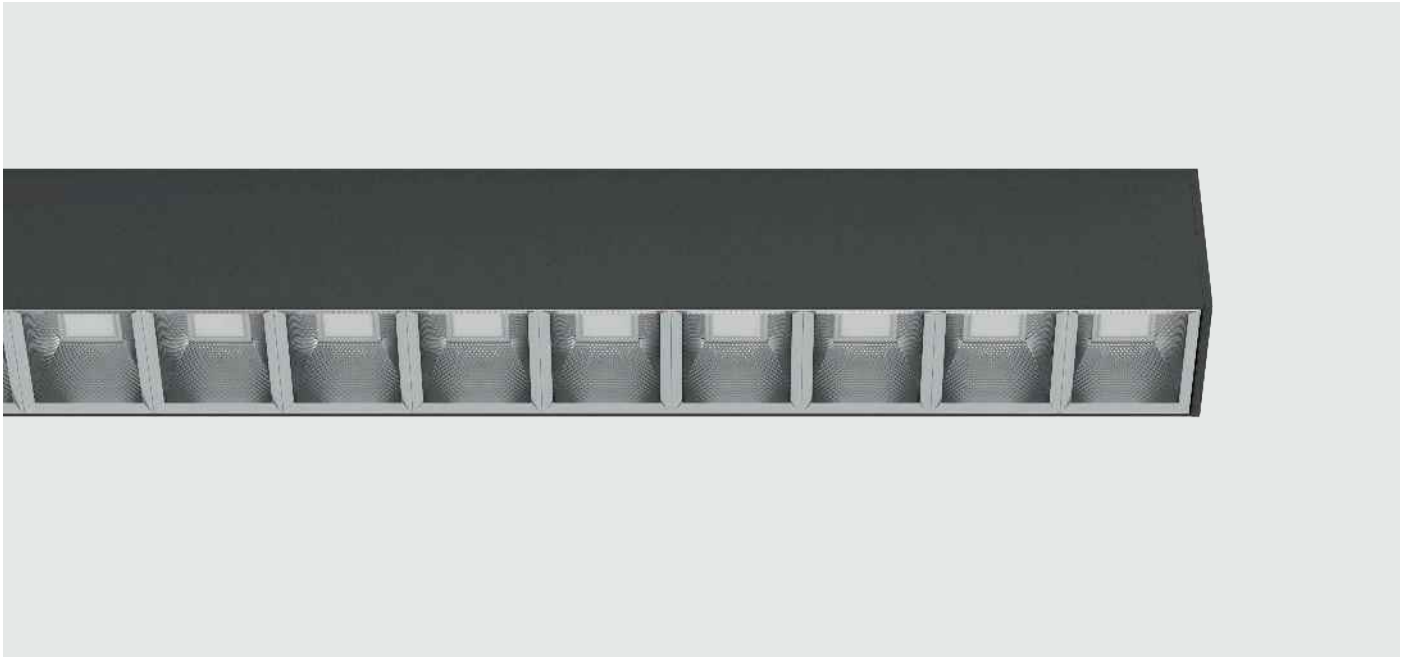

**LED-Anbauleuchte** direktstrahlend. Lichtkanal aus Aluminium-Strangpressprofil mit einer Breite von 50 mm. Fertigung der Leuchtenlänge millimetergenau auf Kundenwunsch möglich. Oberfläche der Leuchte feinstruktur matt pulverbeschichtet ähnlich RAL 9016 weiß, RAL 9006 silber oder RAL 9005 schwarz – auf Anfrage in RAL nach Wahl. Die Leuchte ist ausgestattet mit einem hochwertigen, facettierten BAP-Raster mit einer Auswahl an sieben verschiedenen Farben – Oberfläche hochglänzend bzw. matt. Der LED-Treiber ist im Leuchtengehäuse integriert – wahlweise als on/off oder DALI-Variante. Farbtemperaturen 2700K, 3000K, 4000K oder dynamisch Weiß (2700K–6500K) – Farbwiedergabe CRI>80 oder CRI>90 – Mac Adam ≤3. Weitere Steuerungsoptionen oder Lichtfarben auf Anfrage erhältlich. Außerdem ist die Integration vieler Komponenten, wie beispielsweise Notlicht oder Sensortechnologie, sowie eine Vielzahl weiterer Optionen möglich.

**Surface mounted LED luminaire** with direct beam. Light channel made of extruded aluminium profile with a width of 50 mm. Luminaire length can be manufactured to the exact millimetre on customer request. Surface of the luminaire fine structure matt powder coated similar to RAL 9016 white, RAL 9006 silver or RAL 9005 black - on request in RAL of choice. The luminaire is equipped with a high-quality, faceted BAP louvre with a choice of seven different colours - specular or matt finish. The LED driver is integrated in the luminaire housing - either as on/off or DALI version. Colour temperatures 2700K, 3000K, 4000K or dynamic white (2700K-6500K) - colour rendering CRI>80 or CRI>90 - Mac Adam ≤3. Further control options or light colours available on request. In addition, the integration of many components, such as emergency lighting or sensor technology, as well as a variety of other options is possible.

**Luminaire de surface LED en saillie** à éclairage direct. Canal lumineux en profilé d'aluminium extrudé d'une largeur de 50 mm. Possibilité de fabriquer la longueur du luminaire au millimètre près sur demande du client. Surface du luminaire à structure fine, revêtement par poudre mat similaire à RAL 9016 blanc, RAL 9006 argent ou RAL 9005 noir - sur demande en RAL au choix. Le luminaire est équipé d'une grille BAP à facettes de haute qualité avec un choix de sept couleurs différentes - surface brillante ou mate. Le pilote LED est intégré dans le boîtier du luminaire - au choix sous forme de variante on/off ou DALI. Températures de couleur 2700K, 3000K, 4000K ou blanc dynamique (2700K-6500K) - Rendu des couleurs CRI>80 ou CRI>90 - Mac Adam ≤3. Autres options de commande ou couleurs de lumière disponibles sur demande. En outre, l'intégration de nombreux composants, tels que l'éclairage de secours ou la technologie de détection, une multitude d'autres options sont possibles.

## ÜBERSICHT | OVERVIEW | VUE D'ENSEMBLE

### TECHNICAL DATA

2700K / 3000K / 4000K / 2700-6500K

CRI>80 / CRI>90

MacAdam ≤ 3

up to 152 lm/W, up to 4.323 lm/m

on-off / DALI

direct

BAP-Louvre (UGR <19)

L80 B10 50.000h



RAL colour of your choice



Integration of 3-phase-track



Integration of Multisensor



Welded mitre cuts



Integration of emergency light



Integration of GLOWmini/ GLOWsmall series



Contact us for more options...

### HOUSING COLOUR

schwarz | black | noir  
RAL 9005



silber | silver | argent  
RAL 9006



weiß | white | blanc  
RAL 9016



### BAP LOUVRE COLOUR

silber hochglanz | silver specular | argenté brillant



gold hochglanz | gold specular | doré brillant



silber matt | silver matt | argenté mat



bronze hochglanz | bronze specular | bronze brillant



schwarz hochglanz | black specular | noir brillant



titan hochglanz | titan specular | titan brillant



schwarz matt | black matt | noir mat



**ANBAULEUCHTE „officeLINE50“**  
 SURFACE MOUNTED LUMINAIRE “officeLINE50”  
 LUMINAIRE EN SAILLIE « officeLINE50 »

Bestellbeispiel | Example order | Exemple de commande  
 3.372 mm, CRI>90, 4000K, **direct**, low output on/off, black, gold specular

**OL50A-339401-LOBLG**

1 2 3 4 5 6

1 LÄNGE LENGTH LONGEUR		
491 mm		04
971 mm		09
1.211 mm		12
1.451 mm		14
1.691 mm		16
2.171 mm		21
2.891 mm		28
3.372 mm		33

2 FARBWIEDERGABE COLOUR RENDERING RENDU DES COULEURS		
CRI>80		8
CRI>90		9

3 FARBTEMPERATUR COLOUR TEMPERATURE TEMPÉRATURE DE COULEUR		
2700K (CRI>90 only)		27
3000K		30
4000K		40
2700-6500K (CRI>90 only)		DW

  

4 LEISTUNG & STEUERUNG OUTPUT & CONTROL SORTIE & CONTRÔLE		
low output on/off		LO
low output DALI		LD
high output on/off		HO
high output DALI		HD
dynamic white DALI DT8		DW

5 GEHÄUSEFARBE HOUSING COLOUR COULEUR DU BOÎTIER		
silver RAL 9006		SI
white RAL 9016		WH
black RAL 9005		BL

6 BAP-RASTER FARBE BAP LOUVRE COLOUR GRILLE BAP COULEUR		
silver specular		S
silver matt		M
black specular		N
black matt		B
gold specular		G
bronze specular		C
titan specular		T

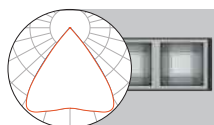
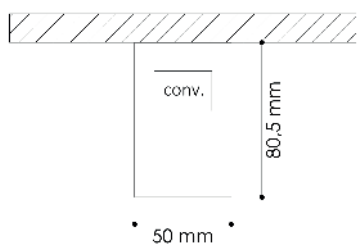

direct

Size [mm]	low output [lm] / [W]	high output [lm] / [W]	KG
491	1.106 / 8,6	2.064 / 16,5	1,4
971	2.212 / 16,7	4.128 / 31,9	2,3
1.211	2.765 / 20,0	5.160 / 39,0	2,8
1.451	3.318 / 23,5	6.192 / 46,0	3,3
1.691	3.871 / 27,0	7.224 / 53,2	3,7
2.171	4.977 / 33,9	9.288 / 67,0	4,7
2.891	6.636 / 43,8	12.384 / 87,9	6,3
3.372	7.742 / 54,0	14.448 / 106,4	7,4

Alle Lumenangaben für 4000K, CRI>80, Reflektor silber hochglanz  
 All lumen values for 4000K, CRI>80, reflector silver specular  
 Toutes les données de lumens pour 4000K, CRI>80, réflecteur argenté brillant

# LINE70

ANBAULEUCHTE | SURFACE MOUNTED LUMINAIRE | LUMINAIRE EN SAILLIE

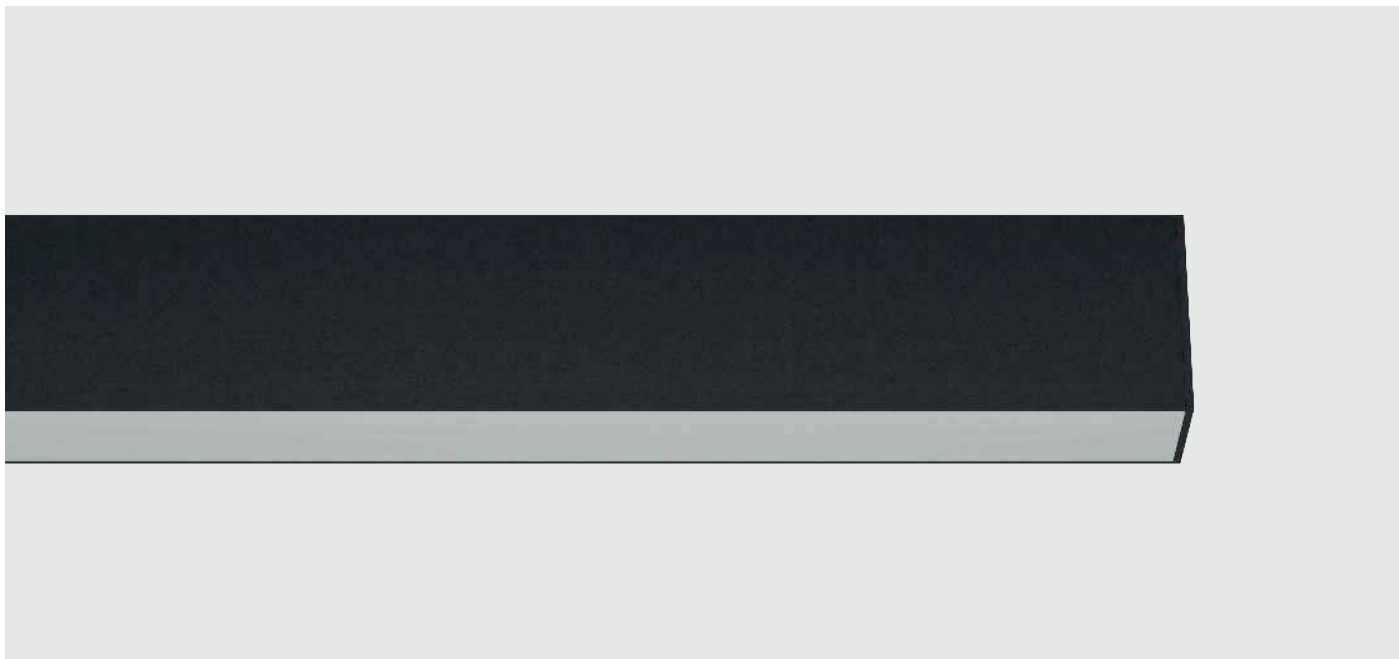

**LED-Anbauleuchte** direktstrahlend. Lichtkanal aus Aluminium-Strangpressprofil mit einer Breite von 71mm. Fertigung der Leuchtenlänge millimetergenau auf Kundenwunsch möglich. Oberfläche der Leuchte feinstruktur matt pulverbeschichtet ähnlich RAL 9016 weiß, RAL 9006 silber oder RAL 9005 schwarz – auf Anfrage in RAL nach Wahl. Diffusor wahlweise in PMMA opal oder PMMA klar mit eingeschobener mikroprismatischer Platte für eine reduzierte Leuchtdichte (UGR<19). Der LED-Treiber ist im Leuchtgehäuse integriert – wahlweise als on/off oder DALI-Variante. Farbtemperaturen 2700K, 3000K, 4000K oder dynamisch Weiß (2700K–6500K) – Farbwiedergabe CRI>80 oder CRI>90 – Mac Adam ≤3. Weitere Steuerungsoptionen oder Lichtfarben auf Anfrage erhältlich. Außerdem ist die Integration vieler Komponenten, wie beispielsweise Notlicht oder Sensortechnologie, sowie eine Vielzahl weiterer Optionen möglich.

**Surface mounted LED luminaire** with direct beam. Light channel made of extruded aluminium profile with a width of 71 mm. Luminaire length can be manufactured to the exact millimetre on customer request. Surface of the luminaire fine structure matt powder coated similar to RAL 9016 white, RAL 9006 silver or RAL 9005 black - on request in RAL of choice. Diffuser either in PMMA opal or PMMA clear with inserted microprismatic plate for reduced luminance (UGR<19). The LED driver is integrated in the luminaire housing - either as on/off or DALI version. Colour temperatures 2700K, 3000K, 4000K or dynamic white (2700K-6500K) - colour rendering CRI>80 or CRI>90 - Mac Adam ≤3. Further control options or light colours available on request. In addition, the integration of many components, such as emergency lighting or sensor technology, as well as a variety of other options is possible.

**Luminaire de surface LED en saillie** à éclairage direct. Canal lumineux en profilé d'aluminium extrudé d'une largeur de 71mm. Fabrication de la longueur du luminaire au millimètre près possible sur demande du client. Surface du luminaire à structure fine, revêtement par poudre mat similaire à RAL 9016 blanc, RAL 9006 argent ou RAL 9005 noir - sur demande en RAL au choix. Diffuseur au choix en PMMA opale ou en PMMA transparent avec plaque microprismatique insérée pour un éblouissement réduit (UGR<19). Le pilote LED est intégré dans le boîtier du luminaire - au choix sous forme de variante on/off ou DALI. Températures de couleur 2700K, 3000K, 4000K ou blanc dynamique (2700K-6500K) - Rendu des couleurs CRI>80 ou CRI>90 - Mac Adam ≤3. Autres options de commande ou couleurs de lumière disponibles sur demande. En outre, l'intégration de nombreux composants, tels que l'éclairage de secours ou la technologie de détection, une multitude d'autres options sont possibles.

## ÜBERSICHT | OVERVIEW | VUE D'ENSEMBLE

### TECHNICAL DATA

2700K / 3000K / 4000K / 2700-6500K

CRI>80 / CRI>90

MacAdam ≤ 3

up to 125 lm/W, up to 2836 lm/m

on-off / DALI

direct

opal / microprism (UGR <19)

L80 B10 50.000h

### HOUSING COLOUR

schwarz | black | noir  
RAL 9005

silber | silver | argent  
RAL 9006

weiß | white | blanc  
RAL 9016



RAL colour of your choice



Integration of Multisensor



Welded mitre cuts



Integration of emergency light



Contact us for more options...

# ANBAULEUCHTE „LINE70“

SURFACE MOUNTED LUMINAIRE “LINE70”  
LUMINAIRE EN SAILLIE « LINE70 »

Bestellbeispiel | Example order | Exemple de commande  
3.134 mm, CRI>90, 4000K, **direct**, low output on/off, black, microprism

**LI70A-319401-LOBLM**

1 2 3 4 5 6

## 1 LÄNGE LENGTH LONGEUR

614 mm	06
974 mm	09
1.214 mm	12
1.454 mm	14
1.694 mm	16
1.934 mm	19
2.174 mm	21
2.414 mm	24
2.894 mm	28
3.134 mm	31
3.856 mm	38

## 2 FARBWIEDERGABE COLOUR RENDERING RENDU DES COULEURS

CRI>80	8
CRI>90	9

## 3 FARBTEMPERATUR COLOUR TEMPERATURE TEMPÉRATURE DE COULEUR

2700K (CRI>90 only)	27
3000K	30
4000K	40
2700-6500K (CRI>90 only)	DW

## 4 LEISTUNG & STEUERUNG OUTPUT & CONTROL SORTIE & CONTRÔLE

low output on/off	LO
low output DALI	LD
high output on/off	HO
high output DALI	HD
dynamic white DALI DT8	DW

## 5 GEHÄUSEFARBE HOUSING COLOUR COULEUR DU BOÎTIER

silver RAL 9006	SI
white RAL 9016	WH
black RAL 9005	BL

## 6 DIFFUSOR DIFFUSER DIFFUSEUR

opal	O
microprism	M

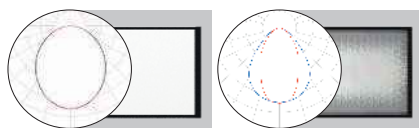
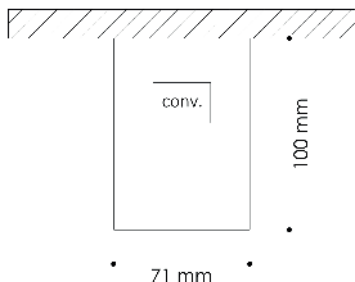

Size [mm]	opal direct		microprism direct		kg
	low output [lm] / [W]	high output [lm] / [W]	low output [lm] / [W]	high output [lm] / [W]	
614	1.077 / 11,8	1.709 / 16,3	1.045 / 11,8	1.608 / 16,3	2,2
974	1.723 / 15,2	2.734 / 25,0	1.672 / 15,2	2.573 / 25,0	3,1
1.214	2.154 / 18,8	3.418 / 30,0	2.090 / 18,8	3.216 / 30,0	3,6
1.454	2.585 / 22,1	4.102 / 35,8	2.508 / 22,1	3.859 / 35,8	4,2
1.694	3.016 / 25,5	4.785 / 41,1	2.926 / 25,5	4.502 / 41,1	4,9
1.934	3.446 / 28,7	5.469 / 46,3	3.344 / 28,7	5.146 / 46,3	5,4
2.174	3.877 / 32,0	6.152 / 52,0	3.762 / 32,0	5.789 / 52,0	6,1
2.414	4.308 / 35,4	6.836 / 57,3	4.180 / 35,4	6.432 / 57,3	6,8
2.894	5.170 / 41,6	8.203 / 69,6	5.016 / 41,6	7.718 / 69,6	8,0
3.134	5.600 / 44,8	8.887 / 75,5	5.434 / 44,8	8.362 / 75,5	8,6
3.856	6.892 / 57,4	10.938 / 92,6	6.688 / 57,4	10.292 / 92,6	10,8

Alle Lumenangaben für 4000K, CRI>80, Microprisma ohne Opalfolie

All lumen values for 4000K, CRI>80, microprism without opal foil

Toutes les données de lumens pour 4000K, CRI>80, microprisme sans feuille opale



# RING50

ANBAULEUCHTE | SURFACE MOUNTED LUMINAIRE | LUMINAIRE EN SAILLIE

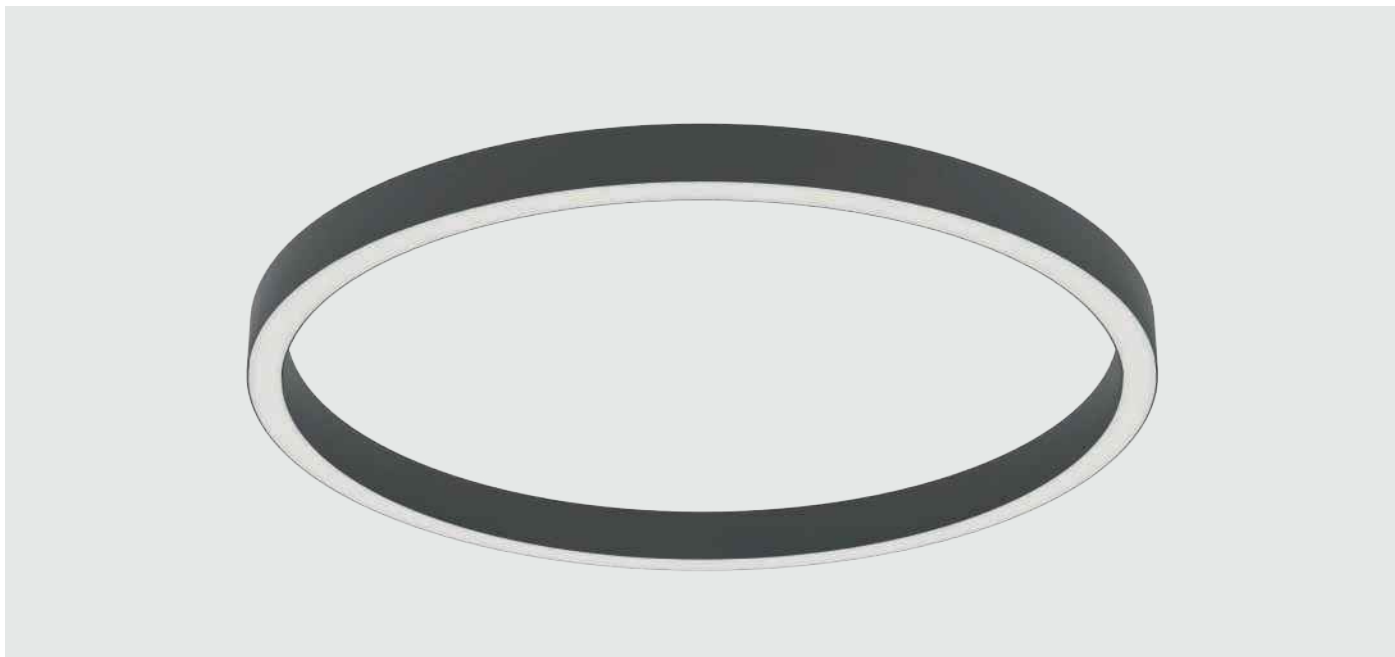

Ringförmige LED-Anbauleuchte direktstrahlend. Lichtkanal aus gerolltem Aluminiumprofil mit einer Breite von 50 mm. Leuchte erhältlich in neun verschiedenen Durchmessern – 1220 und 1575 mm in einem Stück nahtlos verschweißt – die restlichen Größen (2020, 2595, 3090, 3535, 4070, 5050, 6075 mm) bestehend aus zwei bis neun gleich großen Segmenten. Oberfläche der Leuchte feinstruktur matt pulverbeschichtet ähnlich RAL 9016 weiß, RAL 9006 silber oder RAL 9005 schwarz – auf Anfrage in RAL nach Wahl. Diffusor wahlweise in PMMA opal oder PMMA klar mit mikroprismatischer Prägung für eine reduzierte Leuchtdichte (UGR<19). Der LED-Treiber ist im Leuchtgehäuse integriert – wahlweise als on/off oder DALI-Variante. Farbtemperaturen 2700K, 3000K, 4000K oder dynamisch Weiß (2700K–6500K) – Farbwiedergabe CRI>80 oder CRI>90 – Mac Adam ≤3. Weitere Steuerungsoptionen oder Lichtfarben auf Anfrage erhältlich. Außerdem ist die Integration vieler Komponenten, wie beispielsweise Notlicht oder Sensortechnologie, sowie eine Vielzahl weiterer Optionen möglich.

Ring-shaped surface mounted LED luminaire with direct beam. Light channel made of rolled aluminium profile with a width of 50 mm. Luminaire available in nine different diameters - 1220 and 1575 mm seamlessly welded in one piece - the remaining sizes (2020, 2595, 3090, 3535, 4070, 5050, 6075 mm) consisting of two to nine equally sized segments. Surface of the luminaire fine structure matt powder coated similar to RAL 9016 white, RAL 9006 silver or RAL 9005 black - on request in RAL of choice. Diffuser either in PMMA opal or PMMA clear with microprismatic pattern for reduced luminance (UGR<19). The LED driver is integrated in the luminaire housing - either as on/off or DALI version. Colour temperatures 2700K, 3000K, 4000K or dynamic white (2700K-6500K) - colour rendering CRI>80 or CRI>90 - Mac Adam ≤3. Further control options or light colours available on request. In addition, the integration of many components, such as emergency lighting or sensor technology, as well as a variety of other options is possible.

Luminaire LED en saillie en forme d'anneau à éclairage direct. Canal lumineux en profilé d'aluminium roulé d'une largeur de 50 mm. Luminaire disponible en neuf diamètres différents - 1220 et 1575 mm en une seule pièce soudée sans soudure - les autres tailles (2020, 2595, 3090, 3535, 4070, 5050, 6075 mm) se composent de deux à neuf segments de même taille. Surface du luminaire à structure fine matte revêtue par poudre similaire à RAL 9016 blanc, RAL 9006 argent ou RAL 9005 noir - sur demande en RAL au choix. Diffuseur au choix en PMMA opale ou en PMMA transparent avec gaufrage microprismatique pour un éblouissement réduit (UGR<19). Le driver LED est intégré dans le boîtier du luminaire - au choix en version on/off ou DALI. Températures de couleur 2700K, 3000K, 4000K ou blanc dynamique (2700K-6500K) - Rendu des couleurs CRI>80 ou CRI>90 - Mac Adam ≤3. Autres options de commande ou couleurs de lumière disponibles sur demande. En outre, l'intégration de nombreux composants, tels que l'éclairage de secours ou la technologie de détection, une multitude d'autres options sont possibles.

## ÜBERSICHT | OVERVIEW | VUE D'ENSEMBLE

### TECHNICAL DATA

2700K / 3000K / 4000K / 2700-6500K

CRI>80 / CRI>90

MacAdam ≤ 3

up to 131 lm/W

on-off / DALI

direct

opal / microprism (UGR <19)

L80 B10 50.000h

### HOUSING COLOUR

schwarz | black | noir  
RAL 9005

silber | silver | argent  
RAL 9006

weiß | white | blanc  
RAL 9016



RAL colour of your choice



Integration of emergency light



Contact us for more options...

**ANBAULEUCHTE „RING50“**  
 SURFACE MOUNTED LUMINAIRE “RING50”  
 LUMINAIRE EN SAILLIE « RING50 »

Bestellbeispiel | Example order | Exemple de commande  
 6.075 mm, CRI>90, 4000K, **direct**, low output on/off, black, microprism

**RG50A-609401-LOBLM**

1 2 3 4 5 6

1 DURCHMESSER DIAMETER DIAMÈTRE	
1.220 mm (no DW)	12
1.575 mm (no DW)	15
2.020 mm	20
2.595 mm	25
3.090 mm	30
3.535 mm	35
4.070 mm	40
5.050 mm	50
6.075 mm	60

2 FARBWIEDERGABE COLOUR RENDERING RENDU DES COULEURS	
CRI>80	8
CRI>90	9

3 FARBTemperatur COLOUR TEMPERATURE TEMPÉRATURE DE COULEUR	
2700K (CRI>90 only)	27
3000K	30
4000K	40
2700-6500K (CRI>90 only)	DW

4 LEISTUNG & STEUERUNG OUTPUT & CONTROL SORTIE & CONTRÔLE	
low output on/off	LO
low output DALI	LD
high output on/off	HO
high output DALI	HD
dynamic white DALI DT8	DW

5 GEHÄUSEFARBE HOUSING COLOUR COULEUR DU BOÎTIER	
silver RAL 9006	SI
white RAL 9016	WH
black RAL 9005	BL

6 DIFFUSOR DIFFUSER DIFFUSEUR	
opal	O
microprism	M

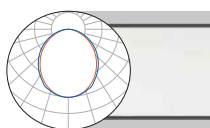
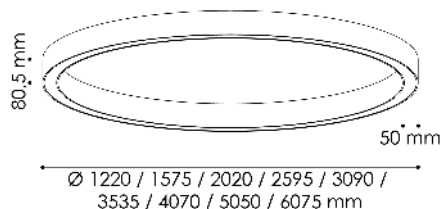

opal  
direct

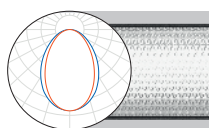

microprism  
direct

Size [mm]	opal direct		microprism direct		KG
	low output [lm] / [W]	high output [lm] / [W]	low output [lm] / [W]	high output [lm] / [W]	
Ø 1.220	4.888 / 38,3	8.376 / 66,3	5.026 / 38,3	8.616 / 66,3	9,9
Ø 1.575	6.110 / 51,2	10.470 / 86,6	6.283 / 51,2	10.770 / 86,6	12,8
Ø 2.020	7.943 / 65,0	13.611 / 113,2	8.168 / 65,0	14.001 / 113,2	16,5
Ø 2.595	10.387 / 85,0	17.799 / 147,9	10.681 / 85,0	18.309 / 147,9	21,1
Ø 3.090	12.220 / 102,4	20.940 / 178,0	12.566 / 102,4	21.540 / 178,0	25,2
Ø 3.535	14.053 / 120,7	24.081 / 209,0	14.451 / 120,7	24.771 / 209,0	28,8
Ø 4.070	15.886 / 137,0	27.222 / 238,0	16.336 / 137,0	28.002 / 238,0	33,2
Ø 5.050	20.163 / 172,0	34.551 / 298,0	20.734 / 172,0	35.541 / 298,0	41,1
Ø 6.075	23.829 / 205,5	40.833 / 357,0	24.504 / 205,5	42.003 / 357,0	49,5

Alle Lumenangaben für 4000K, CRI>80, Gehäusefarbe weiß  
 All lumen values for 4000K, CRI>80, housing colour white  
 Toutes les données de lumens pour 4000K, CRI>80, couleur du boîtier blanc

# RING50mute

ANBAULEUCHTE | SURFACE MOUNTED LUMINAIRE | LUMINAIRE EN SAILLIE



**Ringförmige LED-Anbauleuchte** direktstrahlend. Lichtkanal aus gerolltem Aluminiumprofil mit einer Breite von 50 mm. Leuchte erhältlich in zwei verschiedenen Durchmessern mit integrierten Akustikelemente – 1220 und 1575 mm in einem Stück nahtlos verschweißt. Oberfläche der Leuchte feinstruktur matt pulverbeschichtet ähnlich RAL 9016 weiß, RAL 9006 silber oder RAL 9005 schwarz – auf Anfrage in RAL nach Wahl. Akustikelemente aus recyceltem PET in schwarz, hellgrau meliert, anthrazit meliert, burgunderrot oder olivgrün auswählbar. Diffusor wahlweise in PMMA opal oder PMMA klar mit mikroprismatischer Prägung für eine reduzierte Leuchtdichte (UGR<19). Der LED-Treiber ist im Leuchtgehäuse integriert – wahlweise als on/off oder DA- LI-Variante. Farbtemperaturen 2700K, 3000K oder 4000K – Farbwiedergabe CRI>80 oder CRI>90 – Mac Adam ≤3. Weitere Steuerungsoptionen oder Lichtfarben auf Anfrage erhältlich. Außerdem ist die Integration vieler Komponenten, wie beispielsweise Notlicht oder Sensortechnologie, sowie eine Vielzahl weiterer Optionen möglich.

**Ring-shaped surface mounted LED luminaire** with direct beam. Light channel made of rolled aluminium profile with a width of 50 mm. Luminaire available in two different diameters with integrated acoustic elements - 1220 and 1575 mm seamlessly welded in one piece. Surface of the luminaire fine structure matt powder coated similar to RAL 9016 white, RAL 9006 silver or RAL 9005 black - on request in RAL of choice. Acoustic elements made of recycled PET available in black, light grey mottled, anthracite mottled, burgundy red or olive green. Diffuser either in PMMA opal or PMMA clear with microprismatic pattern for reduced luminance (UGR<19). The LED driver is integrated in the luminaire housing - either as on/ off or DALI version. Colour temperatures 2700K, 3000K or 4000K - colour rendering CRI>80 or CRI>90 - Mac Adam ≤3. Further control options or light colours available on request. In addition, the integration of many components, such as emergency lighting or sensor technology, as well as a variety of other options is possible.

**Luminaire LED en saillie en forme d'anneau** à éclairage direct ou direct-indirect. Canal lumineux en profilé d'aluminium roulé d'une largeur de 50 mm. Luminaire disponible en deux diamètres différents avec élément acoustique intégré - 1220 et 1575 mm en une seule pièce soudée sans soudure. Surface du luminaire à structure fine matte revêtue par poudre similaire à RAL 9016 blanc, RAL 9006 argent ou RAL 9005 noir - sur demande en RAL au choix. Éléments acoustiques fabriqués en PET recyclé en noir, gris clair chiné, anthracite chiné, rouge bordeaux ou vert olive au choix. Diffuseur au choix en PMMA opale ou en PMMA transparent avec gaufrage microprismatique pour un éblouissement réduit (UGR<19). Le pilote LED est intégré dans le boîtier du luminaire - au choix en version on/off ou DALI. Températures de couleur 2700K, 3000K ou 4000K - Rendu des couleurs CRI>80 ou CRI>90 - Mac Adam ≤3. Autres options de commande ou couleurs de lumière disponibles sur demande. En outre, l'intégration de nombreux composants, tels que l'éclairage de secours ou la technologie de détection, une multitude d'autres options sont possibles.

## ÜBERSICHT | OVERVIEW | VUE D'ENSEMBLE

### TECHNICAL DATA

2700K / 3000K / 4000K

CRI>80 / CRI>90

MacAdam ≤ 3

up to 131 lm/W

on-off / DALI

direct

opal / microprism (UGR <19)

L80 B10 50.000h

acoustic material - fire classification: B-s2, d0 (EN13501-1:3018)



RAL colour of your choice



Integration of emergency light



Contact us for more options...

### HOUSING COLOUR

schwarz | black | *noir*  
RAL 9005



silber | silver | *argent*  
RAL 9006



weiß | white | *blanc*  
RAL 9016



### COLOUR ACOUSTIC PANEL

schwarz | black | *noir*



hellgrau meliert | light grey mottled|  
*gris clair chiné*



anthrazit meliert | anthracite mottled|  
*anthracite chiné*



burgunderrot | burgundy red | *rouge bourgogne*



olivgrün | olive green | *vert olive*



**ANBAULEUCHTE „RING50mute“**  
 SURFACE MOUNTED LUMINAIRE “RING50mute”  
 LUMINAIRE EN SAILLIE « RING50mute »

Bestellbeispiel | Example order | Exemple de commande  
 1.220 mm, CRI90, 4000K, **direct**, low output on/off, black, olive, microprism

**RG5MA-129401-LOBOM**

1 2 3 4 5 6 7

<b>1</b>	<b>DURCHMESSER</b>	
	DIAMETER DIAMÈTRE	
	1.220 mm	<b>12</b>
	1.575 mm	<b>15</b>

<b>2</b>	<b>FARBWIEDERGABE</b>	
	COLOUR RENDERING RENDU DES COULEURS	
	CRI>80	<b>8</b>
	CRI>90	<b>9</b>

<b>3</b>	<b>FARBTEMPERATUR</b>	
	COLOUR TEMPERATURE TEMPÉRATURE DE COULEUR	
	2700K (CRI>90 only)	<b>27</b>
	3000K	<b>30</b>
	4000K	<b>40</b>

<b>4</b>	<b>LEISTUNG &amp; STEUERUNG</b>	
	OUTPUT & CONTROL SORTIE & CONTRÔLE	
	low output on/off	<b>LO</b>
	low output DALI	<b>LD</b>
	high output on/off	<b>HO</b>
	high output DALI	<b>HD</b>

<b>5</b>	<b>GEHÄUSEFARBE</b>	
	HOUSING COLOUR COULEUR DU BOÎTIER	
	silver RAL 9006	<b>S</b>
	white RAL 9016	<b>W</b>
	black RAL 9005	<b>B</b>

<b>6</b>	<b>FARBE AKUSTIKPLATTE</b>	
	COLOUR ACOUSTIC PANEL COULEUR PANNEAU ACOUSTIQUE	
	black	<b>B</b>
	light grey mottled	<b>S</b>
	anthracite mottled	<b>A</b>
	burgundy red	<b>R</b>
	olive green	<b>O</b>

<b>6</b>	<b>DIFFUSOR</b>	
	DIFFUSER DIFFUSEUR	
	opal	<b>O</b>
	microprism	<b>M</b>

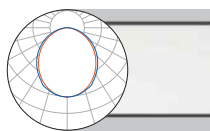
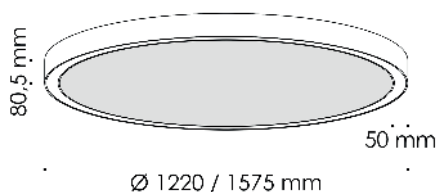

opal  
direct

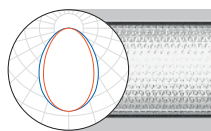

microprism  
direct

Size [mm]	low output		high output		 [kg]
	[lm] / [W]	[lm] / [W]	[lm] / [W]	[lm] / [W]	
Ø 1.220	4.888 / 38,3	8.376 / 66,3	5.026 / 38,3	8.616 / 66,3	14,0
Ø 1.575	6.110 / 51,2	10.470 / 86,6	6.283 / 51,2	10.770 / 86,6	19,8

Alle Lumenangaben für 4000K, CRI>80, Gehäusefarbe weiß  
 All lumen values for 4000K, CRI>80, housing colour white  
 Toutes les données de lumens pour 4000K, CRI>80, couleur du boîtier blanc

# FLEX50

ANBAULEUCHTE | SURFACE MOUNTED LUMINAIRE | LUMINAIRE EN SAILLIE



**LED-Anbauleuchte als Segment** zur individuellen Kombination. Direktstrahlend. Lichtkanal aus gerolltem Aluminiumprofil mit einer Breite von 50 mm. Segmente erhältlich in 13 verschiedenen Varianten – zwei Stück als gerades Profil 980 oder 1960 mm – die restlichen Segmente sind als 40°, 45°, 60°- bzw. 90°-Stücke mit einem Mittelradius von 585 bis 3012,5 mm erhältlich. Oberfläche der Leuchte feinstruktur matt pulverbeschichtet ähnlich RAL 9016 weiß, RAL 9006 silber oder RAL 9005 schwarz – auf Anfrage in RAL nach Wahl. Diffusor wahlweise in PMMA opal oder PMMA mit mikroprismatischer Prägung für eine reduzierte Leuchtdichte (UGR<19). Der LED-Treiber ist im Leuchtgehäuse integriert – wahlweise als on/off oder DALI-Variante. Farbtemperaturen 2700K, 3000K, 4000K oder dynamisch Weiß (2700K–6500K) – Farbwiedergabe CRI>80 oder CRI>90 – Mac Adam ≤3. Weitere Steuerungsoptionen oder Lichtfarben auf Anfrage erhältlich. Außerdem ist die Integration vieler Komponenten, wie beispielsweise Notlicht oder Sensortechnologie, sowie eine Vielzahl weiterer Optionen möglich.

**Surface mounted LED luminaire as segment** for individual combination. Direct beam. Light channel made of rolled aluminium profile with a width of 50 mm. Segments available in 13 different versions - two pieces as straight profile 980 or 1960 mm - the remaining segments are available as 40°, 45°, 60° or 90° pieces with a middle radius of 585 to 3012.5 mm. Surface of the luminaire fine structure matt powder coated similar to RAL 9016 white, RAL 9006 silver or RAL 9005 black - on request in RAL of choice. Diffuser either in PMMA opal or PMMA clear with microprismatic pattern for reduced luminance (UGR<19). The LED driver is integrated in the luminaire housing - either as on/off or DALI version. Colour temperatures 2700K, 3000K, 4000K or dynamic white (2700K-6500K) - colour rendering CRI>80 or CRI>90 - Mac Adam ≤3. Further control options or light colours available on request. In addition, the integration of many components, such as emergency lighting or sensor technology, as well as a variety of other options is possible.

**Luminaire LED en saillie a segment** pour une combinaison individuelle. Éclairage direct de la surface. Canal lumineux en profilé d'aluminium roulé d'une largeur de 50 mm. Segments disponibles en 13 variantes différentes - deux pièces en tant que profil droit de 980 ou 1960 mm - les autres segments sont disponibles en tant que pièces de 40°, 45°, 60° ou 90° avec un rayon central de 585 à 3012,5 mm. Surface du luminaire à structure fine matte revêtue par poudre similaire à RAL 9016 blanc, RAL 9006 argent ou RAL 9005 noir - sur demande en RAL au choix. Diffuseur au choix en PMMA opale ou en PMMA transparent avec gaufrage microprismatique pour un éblouissement réduit (UGR<19). Le driver LED est intégré dans le boîtier du luminaire - au choix en version on/off ou DALI. Températures de couleur 2700K, 3000K, 4000K ou blanc dynamique (2700K-6500K) - Rendu des couleurs CRI>80 ou CRI>90 - Mac Adam ≤3. Autres options de commande ou couleurs de lumière disponibles sur demande. En outre, l'intégration de nombreux composants, tels que l'éclairage de secours ou la technologie de détection, une multitude d'autres options sont possibles.

## ÜBERSICHT | OVERVIEW | VUE D'ENSEMBLE

### TECHNICAL DATA

2700K / 3000K / 4000K / 2700-6500K

CRI>80 / CRI>90

MacAdam ≤ 3

up to 131 lm/W

on-off / DALI

direct

opal / microprism (UGR <19)

L80 B10 50.000h

### HOUSING COLOUR

schwarz | black | noir  
RAL 9005

silber | silver | argent  
RAL 9006

weiß | white | blanc  
RAL 9016



RAL colour of your choice



Integration of emergency light



Contact us for more options...

**ANBAULEUCHTE „FLEX50“**  
 SURFACE MOUNTED LUMINAIRE “FLEX50”  
 LUMINAIRE EN SAILLIE « FLEX50 »

Bestellbeispiel | Example order | Exemple de commande  
 straight, 1.960 mm, CRI>90, 4000K, **direct**, low output on/off, black, microprism

**FX50A-L29401-LOBLM**

1 2 3 4 5 6

1 GRÖSSE SIZE TAILLE	
straight, L 980 mm	L1
straight, L 1.960 mm	L2
90°, R 585 mm (no DW)	19
90°, R 762,5 mm (no DW)	29
90°, R 985 mm	39
45°, R 1.272,5 mm	44
90°, R 1.272,5 mm	49
60°, R 1.520 mm	56
90°, R 1.520 mm	59
60°, R 1.742,5 mm	66
60°, R 2.010 mm	76
45°, R 2.500 mm	84
40°, R 3.012,5 mm	94

2 FARBWIEDERGABE COLOUR RENDERING RENDU DES COULEURS	
CRI>80	8
CRI>90	9

3 FARBTemperatur COLOUR TEMPERATURE TEMPÉRATURE DE COULEUR	
2700K (CRI>90 only)	27
3000K	30
4000K	40
2700-6500K (CRI>90 only)	DW

4 LEISTUNG & STEUERUNG OUTPUT & CONTROL SORTIE & CONTRÔLE	
low output on/off	LO
low output DALI	LD
high output on/off	HO
high output DALI	HD
dynamic white DALI DT8	DW

5 GEHÄUSEFARBE HOUSING COLOUR COULEUR DU BOÎTIER	
silver RAL 9006	SI
white RAL 9016	WH
black RAL 9005	BL

6 DIFFUSOR DIFFUSER DIFFUSEUR	
opal	O
microprism	M

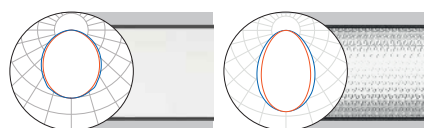
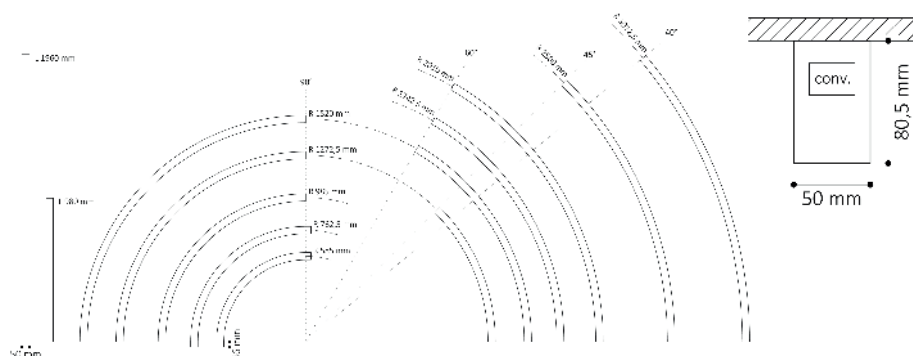

opal direct

microprism direct

Size [mm]	opal direct		microprism direct		kg
	low output [lm] / [W]	high output [lm] / [W]	low output [lm] / [W]	high output [lm] / [W]	
straight, L 980	1.222 / 11,2	2.094 / 18,1	1.257 / 11,2	2.153 / 18,1	2,6
straight, L 1.960	2.554 / 23,3	4.377 / 37,8	2.626 / 23,3	4.377 / 37,8	5,3
90°, R 585	1.224 / 9,6	2.096 / 16,6	1.256 / 9,6	2.156 / 16,6	2,6
90°, R 762,5	1.530 / 12,8	2.620 / 21,6	1.570 / 12,8	2.695 / 21,6	3,3
90°, R 985	1.836 / 16,3	3.144 / 28,3	1.884 / 16,3	3.234 / 28,3	4,3
45°, R 1.272,5	1.224 / 10,6	2.096 / 18,5	1.256 / 10,6	2.156 / 18,5	2,7
90°, R 1.272,5	2.448 / 21,3	4.192 / 37,0	2.512 / 21,3	4.312 / 37,0	5,5
60°, R 1.520	1.836 / 17,1	3.144 / 29,6	1.884 / 17,1	3.234 / 29,6	4,3
90°, R 1.520	3.060 / 25,6	5.240 / 44,5	3.140 / 25,6	5.390 / 44,5	6,5
60°, R 1.742,5	2.142 / 20,1	3.668 / 34,8	2.198 / 20,1	3.773 / 34,8	5,0
60°, R 2.010	2.754 / 22,8	4.716 / 39,7	2.826 / 22,8	4.851 / 39,7	5,7
45°, R 2.500	2.448 / 21,5	4.192 / 37,2	2.512 / 21,5	4.312 / 37,2	5,3
40°, R 3.012,5	2.754 / 22,8	4.716 / 39,7	2.826 / 22,8	4.851 / 39,7	5,7

Alle Lumenangaben für 4000K, CRI>80, Gehäusefarbe weiß  
 All lumen values for 4000K, CRI>80, housing colour white  
 Toutes les données de lumens pour 4000K, CRI>80, couleur du boîtier blanc

ACCESSORIES	
END CAPS - 2 pcs.	
black	FX50A-EC-BL
silver	FX50A-EC-SI
white	FX50A-EC-WH



# OVOID50

ANBAULEUCHTE | SURFACE MOUNTED LUMINAIRE | LUMINAIRE EN SAILLIE

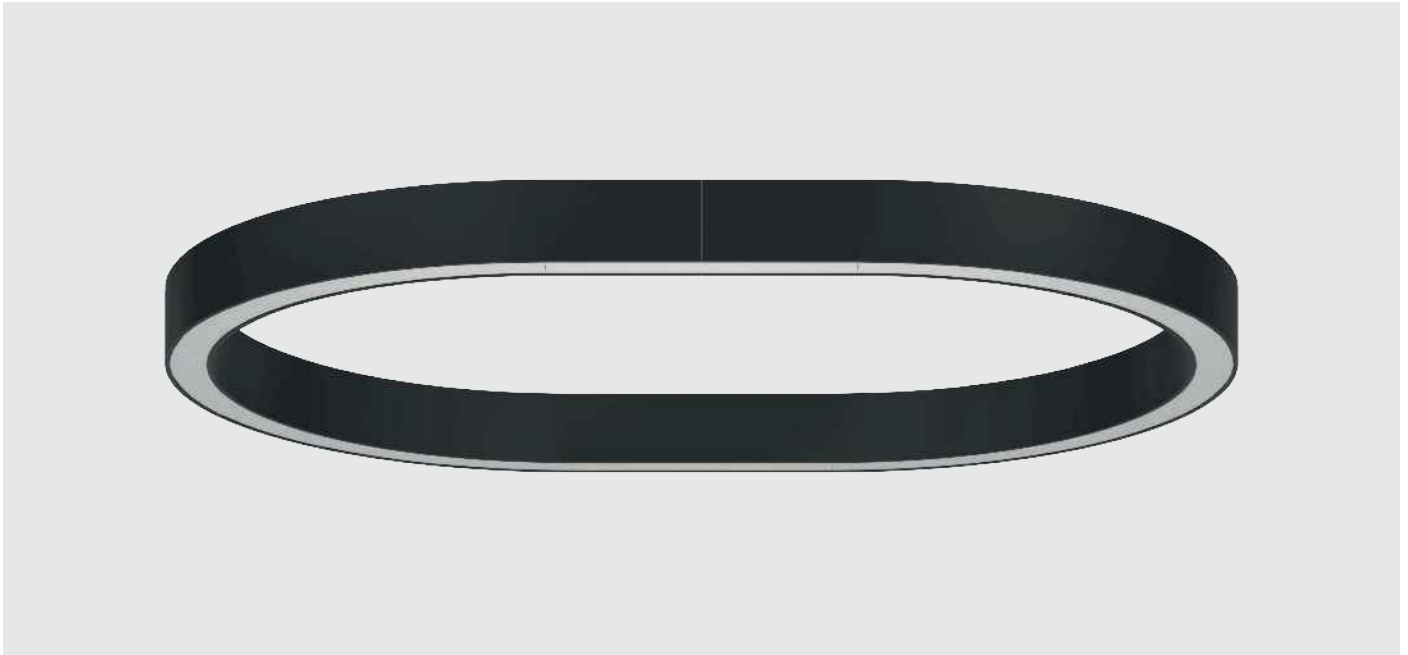

**LED-Anbauleuchte** als ovalförmige Standardleuchte. Direktstrahlend. Lichtkanal aus gerolltem Aluminiumprofil mit einer Breite von 50 mm. Ovale Standardleuchte erhältlich mit den Abmessungen 1.160 mm x 850 mm oder 2.500 mm x 1.800 mm. Oberfläche der Leuchte feinstruktur matt pulverbeschichtet ähnlich RAL 9016 weiß, RAL 9006 silber oder RAL 9005 schwarz – auf Anfrage in RAL nach Wahl. Diffusor wahlweise in PMMA opal oder PMMA mit mikroprismatischer Prägung für eine reduzierte Leuchtdichte (UGR<19) Der LED-Treiber ist im Leuchtgehäuse integriert – wahlweise als on/off oder DALI-Variante. Farbtemperaturen 2700K, 3000K, 4000K oder dynamisch Weiß (2700K-6500K) – Farbwiedergabe CRI>80 oder CRI>90 – Mac Adam  $\leq 3$ . Weitere Steuerungsoptionen oder Lichtfarben auf Anfrage erhältlich. Außerdem ist die Integration vieler Komponenten, wie beispielsweise Notlicht oder Sensortechnologie, sowie eine Vielzahl weiterer Optionen möglich.

**Surface mounted LED luminaire** in an oval-shaped standard design. Direct beam. Light channel made of rolled aluminium profile with a width of 50 mm. Oval standard luminaire available in dimensions 1.160 mm x 850 mm or 2.500 mm x 1.800 mm. Surface of the luminaire fine structure matt powder coated similar to RAL 9016 white, RAL 9006 silver or RAL 9005 black - on request in RAL of choice. Diffuser either in PMMA opal or PMMA clear with microprismatic pattern for reduced luminance (UGR<19). The LED driver is integrated in the luminaire housing - either as on/off or DALI version. Colour temperatures 2700K, 3000K, 4000K or dynamic white (2700K-6500K) - colour rendering CRI>80 or CRI>90 - Mac Adam  $\leq 3$ . Further control options or light colours available on request. In addition, the integration of many components, such as emergency lighting or sensor technology, as well as a variety of other options is possible.

**Luminaire LED en saillie** au design standard en forme ovale. Éclairage direct de la surface. Luminaire standard ovale disponible dans les dimensions 1.160 mm x 850 mm ou 2.500 mm x 1.800 mm. Surface du luminaire à structure fine matte revêtue par poudre similaire à RAL 9016 blanc, RAL 9006 argent ou RAL 9005 noir - sur demande en RAL au choix. Diffuseur au choix en PMMA opale ou en PMMA transparent avec gaufrage microprismatique pour un éblouissement réduit (UGR<19). Le driver LED est intégré dans le boîtier du luminaire - au choix en version on/ off ou DALI. Températures de couleur 2700K, 3000K, 4000K ou blanc dynamique (2700K-6500K) - Rendu des couleurs CRI>80 ou CRI>90 - Mac Adam  $\leq 3$ . Autres options de commande ou couleurs de lumière disponibles sur demande. En outre, l'intégration de nombreux composants, tels que l'éclairage de secours ou la technologie de détection, une multitude d'autres options sont possibles.

## ÜBERSICHT | OVERVIEW | VUE D'ENSEMBLE

### TECHNICAL DATA

2700K / 3000K / 4000K / 2700-6500K

CRI>80 / CRI>90

MacAdam  $\leq 3$

up to 112 lm/W

on-off / DALI

direct

opal / microprism (UGR <19)

L80 B10 50.000h

### HOUSING COLOUR

schwarz | black | noir  
RAL 9005

silber | silver | argent  
RAL 9006

weiß | white | blanc  
RAL 9016



RAL colour of your choice



Integration of emergency light



Contact us for more options...

**ANBAULEUCHE „OVOID50“**  
 SURFACE MOUNTED LUMINAIRE “OVOID50”  
 LUMINAIRE EN SAILLIE « OVOID50 »

Bestellbeispiel | Example order | Exemple de commande  
 1160x850 mm, CRI90, 4000K, **direct**, low output on/off, black, microprism

**OV50A-119401-LOBLM**

1 2 3 4 5 6

**1 GRÖSSE**  
 SIZE  
 TAILLE

L 1160 mm, W 850 mm	<b>11</b>
L 2500 mm, W 1800 mm	<b>25</b>

**2 FARBWIEDERGABE**  
 COLOUR RENDERING  
 RENDU DES COULEURS

CRI>80	<b>8</b>
CRI>90	<b>9</b>

**3 FARBTEMPERATUR**  
 COLOUR TEMPERATURE  
 TEMPÉRATURE DE COULEUR

2700K (CRI>90 only)	<b>27</b>
3000K	<b>30</b>
4000K	<b>40</b>
2700-6500K (CRI>90 only)	<b>DW</b>

**4 LEISTUNG & STEUERUNG**  
 OUTPUT & CONTROL  
 SORTIE & CONTRÔLE

low output on/off	<b>LO</b>
low output DALI	<b>LD</b>
high output on/off	<b>HO</b>
high output DALI	<b>HD</b>
dynamic white DALI DT8	<b>DW</b>

**5 GEHÄUSEFARBE**  
 HOUSING COLOUR  
 COULEUR DU BOÎTIER

silver RAL 9006	<b>SI</b>
white RAL 9016	<b>WH</b>
black RAL 9005	<b>BL</b>

**6 ABDECKUNG**  
 COVER  
 COUVERTURE

opal	<b>O</b>
microprism	<b>M</b>

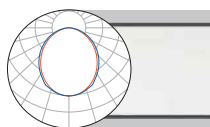
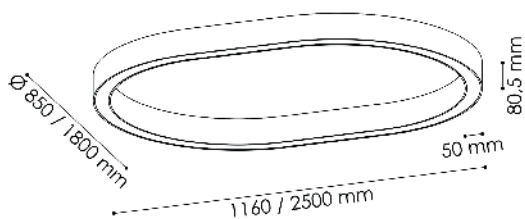

opal  
direct

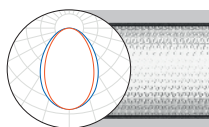

microprism  
direct

Size [mm]	low output [lm] / [W]	high output [lm] / [W]	low output [lm] / [W]	high output [lm] / [W]	
1.160 x 850	3.455 / 32,5	5.527 / 57,0	3.656 / 32,5	5.899 / 57,0	8,3
2.500 x 1.800	7.539 / 71,0	12.060 / 124,4	7.977 / 71,0	12.869 / 124,4	17,7

Alle Lumenangaben für 4000K, CRI>80, Gehäusefarbe weiß

All lumen values for 4000K, CRI>80, housing colour white

Toutes les données de lumens pour 4000K, CRI>80, couleur du boîtier blanc

# ROUND90

ANBAULEUCHTE | SURFACE MOUNTED LUMINAIRE | LUMINAIRE EN SAILLIE



**Runde LED-Flächenleuchte zur Anbaumontage.** Direktstrahlend oder direkt-indirektstrahlend. Gehäuse aus gerolltem Aluminiumprofil, nahtlos verschweißt. Fertigung der Leuchte in vier Durchmesser: 350, 450, 650 und 950 mm mit einer Gesamthöhe von 90 mm. Oberfläche pulverbeschichtet feinstruktur matt ähnlich RAL 9016 weiß, RAL 9006 silber oder RAL 9005 schwarz – auf Anfrage in RAL nach Wahl. Die durchdachte Konstruktion der Leuchte ermöglicht ein Design in zahlreichen Farbkombinationen – zwischen Gehäusefarbe und Dekorring kann beliebig kombiniert werden. Um der Leuchtenfamilie neben den Standardfarben einen dekorativen Touch zu verleihen, steht der Dekorring auch in den strukturierten Spezialoberflächen schlaggold, schlagsilber und schlagbronze zur Auswahl. Diffusor in PMMA wahlweise opal, mikroprismatisch inkl. Streufolie oder nur mikroprismatisch (office special) für eine reduzierte Leuchtdichte (UGR<19). Einfache Montage durch Einschieben des Leuchtgehäuses in den Baldachin. Der LED-Treiber ist im Leuchtgehäuse integriert – wahlweise als on/off oder DALI-Variante. Farbtemperaturen 2700K, 3000K, 4000K oder dynamisch Weiß (2700K–6500K) – Farbwiedergabe CRI>80 oder CRI>90 – Mac Adam ≤3. Weitere Steuerungsoptionen oder Lichtfarben auf Anfrage möglich. Außerdem ist die Integration vieler Komponenten, wie beispielsweise Notlicht oder Sensortechnologie, sowie eine Vielzahl weiterer Optionen möglich.

**Round surface mounted LED luminaire.** Direct beam or direct-indirect beam. Housing made of rolled aluminium profile, seamlessly welded. Luminaire manufactured in four diameters: 350, 450, 650 and 950 mm with a total height of 90 mm. Surface powder coated fine structure matt similar to RAL 9016 white, RAL 9006 silver or RAL 9005 black - on request in RAL of choice. The sophisticated construction of the luminaire allows a design in numerous colour combinations - any combination of housing colour and decorative ring is possible. To give the luminaire family a decorative touch in addition to the standard colours, the decorative ring is also available in the special textured surfaces beaten gold, beaten silver and beaten bronze. Diffuser in PMMA either opal, microprism incl. diffuser foil or only microprism (office special) for reduced luminance (UGR<19). Easy installation by sliding the luminaire housing into the canopy. The LED driver is integrated in the luminaire housing - either as on/off or DALI version. Colour temperatures 2700K, 3000K, 4000K or dynamic white (2700K-6500K) - colour rendering CRI>80 or CRI>90 - Mac Adam ≤3. Further control options or light colours available on request. In addition, the integration of many components, such as emergency lighting or sensor technology, as well as a variety of other options is possible.

**Luminaire LED rond en saillie.** Éclairage direct ou éclairage direct-indirect. Boîtier en profilé d'aluminium roulé, soudé sans soudeuse. Fabrication du luminaire en quatre diamètres : 350, 450, 650 et 950 mm avec une hauteur totale de 90 mm. Surface revêtue par poudre à structure fine mate similaire à RAL 9016 blanc, RAL 9006 argent ou RAL 9005 noir - sur demande en RAL au choix. La construction bien pensée du luminaire permet un design dans de nombreuses combinaisons de couleurs - il est possible de combiner à volonté entre la couleur du boîtier et l'anneau décoratif. Pour donner à la famille de luminaires une touche décorative en plus des couleurs standard, l'anneau décoratif est également disponible dans les surfaces spéciales structurées or choc, argent choc et bronze choc. Diffuseur en PMMA au choix opale, microprismatique y compris feuille diffuseuse ou uniquement microprismatique (office special) pour un éblouissement réduit (UGR<19). Montage facile en insérant le corps du luminaire dans le canopy. Le driver LED est intégré dans le boîtier du luminaire - au choix en version on/off ou DALI. Températures de couleur 2700K, 3000K, 4000K ou blanc dynamique (2700K-6500K) - Rendu des couleurs CRI>80 ou CRI>90 - Mac Adam ≤3. Autres options de commande ou couleurs de lumière possibles sur demande. En outre, l'intégration de nombreux composants, tels que l'éclairage de secours ou la technologie des capteurs, une multitude d'autres options sont possibles.

## ÜBERSICHT | OVERVIEW | VUE D'ENSEMBLE

TECHNICAL DATA	
2700K / 3000K / 4000K / 2700-6500K	
CRI>80 / CRI>90	
MacAdam ≤ 3	
up to 174 lm/W	
on-off / DALI	
direct / direct + indirect	
opal / microprism / office special (UGR <19)	
L80 B10 50.000h	
HOUSING COLOUR	
schwarz   black   noir RAL 9005	
silber   silver   argent RAL 9006	
weiß   white   blanc RAL 9016	

RAL colour of your choice	Integration of Multisensor	Integration of emergency light	Contact us for more options...					
DECORATION RING COLOUR								
schwarz   black   noir RAL 9005		schlaggold   beaten gold   or texturés						
silber   silver   argent RAL 9006		schlagsilber   beaten silver   argent texturés						
weiß   white   blanc RAL 9016		schlagbronze   beaten bronze   bronze texturés						

**ANBAULEUCHTE „ROUND90“**  
**SURFACE MOUNTED LUMINAIRE “ROUND90”**  
**LUMINAIRE EN SAILLIE « ROUND90 »**

Bestellbeispiel | Example order | Exemple de commande  
 350 mm, CRI>90, 4000K, direct, low output on/off, black, beaten gold, microprism

**RO90A-359401-LOBGM**

1 2 3 4 5 6 7 8

<b>1</b>	<b>DURCHMESSER</b> DIAMETER DIAMÈTRE	
	350 mm	<b>35</b>
	450 mm	<b>45</b>
	650 mm	<b>65</b>
	950 mm	<b>95</b>
<b>2</b>	<b>FARBWIEDERGABE</b> COLOUR RENDERING RENDU DES COULEURS	
	CRI>80	<b>8</b>
	CRI>90	<b>9</b>
<b>3</b>	<b>FARBTEMPERATUR</b> COLOUR TEMPERATURE TEMPÉRATURE DE COULEUR	
	2700K (CRI>90 only)	<b>27</b>
	3000K	<b>30</b>
	4000K	<b>40</b>
	2700-6500K (CRI>90 only)	<b>DW</b>

<b>4</b>	<b>LICHTVERTEILUNG</b> LIGHT DISTRIBUTION DISTRIBUTION DE LA LUMIÈRE	
	direct	<b>1</b>
	direct + indirect	<b>2</b>
<b>5</b>	<b>LEISTUNG &amp; STEUERUNG</b> OUTPUT & CONTROL SORTIE & CONTRÔLE	
	low output on/off	<b>LO</b>
	low output DALI	<b>LD</b>
	high output on/off	<b>HO</b>
	high output DALI	<b>HD</b>
	dynamic white DALI DT8	<b>DW</b>
<b>6</b>	<b>GEHÄUSEFARBE</b> HOUSING COLOUR COULEUR DU BOÎTIER	
	silver RAL 9006	<b>S</b>
	white RAL 9016	<b>W</b>
	black RAL 9005	<b>B</b>

<b>7</b>	<b>DEKORRING FARBE</b> DECORATION RING COLOUR BAGUE DÉCORATIVE COULEUR	
	silver RAL 9006	<b>S</b>
	white RAL 9016	<b>W</b>
	black RAL 9005	<b>B</b>
	beaten gold	<b>G</b>
	beaten silver	<b>A</b>
	beaten bronze	<b>C</b>
<b>8</b>	<b>DIFFUSOR</b> DIFFUSER DIFFUSEUR	
	opal	<b>O</b>
	microprism	<b>M</b>
	office special	<b>B</b>

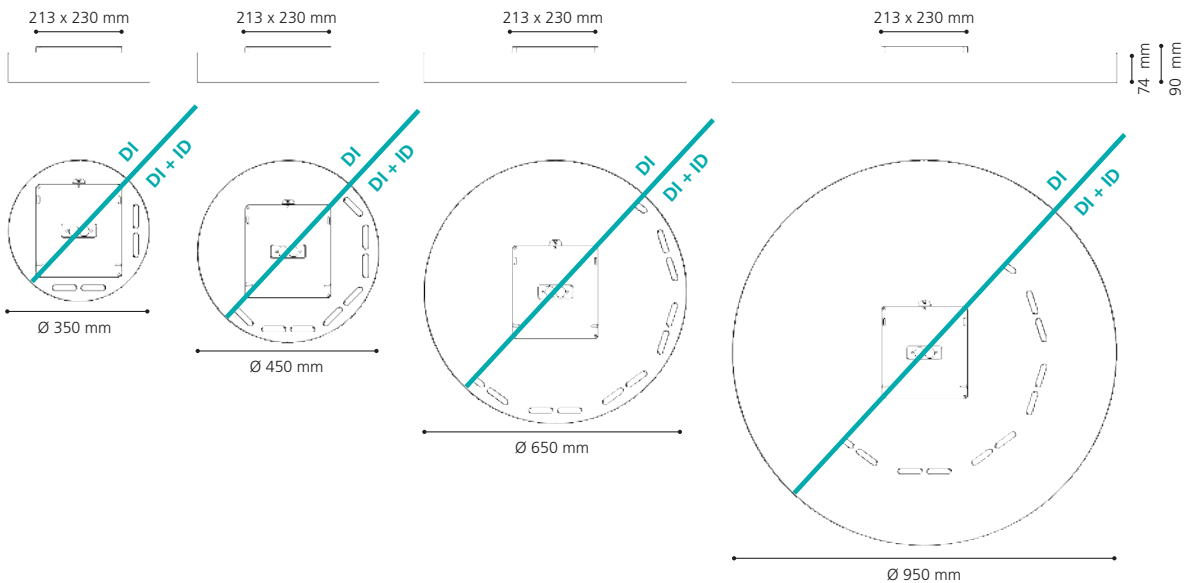

Size [mm]	opal direct		microprism direct		office special direct		opal direct + indirect		microprism direct + indirect		office special direct + indirect		kg
	low output [lm] / [W]	high output [lm] / [W]	low output [lm] / [W]	high output [lm] / [W]	low output [lm] / [W]	high output [lm] / [W]	low output [lm] / [W]	high output [lm] / [W]	low output [lm] / [W]	high output [lm] / [W]	low output [lm] / [W]	high output [lm] / [W]	
Ø 350	1.158 / 8,5	1.826 / 12,9	1.077 / 8,5	1.697 / 12,9	1.213 / 8,5	1.905 / 12,9	1.747 / 11,9	2.625 / 17,5	1.661 / 11,9	2.493 / 17,5	1.795 / 11,9	2.691 / 17,5	3,4
Ø 450	2.258 / 15,5	3.561 / 23,5	2.099 / 15,5	3.309 / 23,5	2.364 / 15,5	3.715 / 23,5	3.207 / 20,7	4.820 / 30,3	3.050 / 20,7	4.577 / 30,2	3.296 / 20,7	4.942 / 30,3	4,0
Ø 650	4.114 / 27,2	6.489 / 41,3	3.825 / 27,2	6.029 / 41,3	4.309 / 27,2	6.770 / 41,3	5.534 / 35,2	8.317 / 51,3	5.263 / 35,2	7.897 / 51,3	5.687 / 35,2	8.526 / 51,3	7,6
Ø 950	9.102 / 56,7	14.360 / 86,0	8.466 / 56,7	13.342 / 86,0	9.535 / 56,7	14.982 / 86,0	11.036 / 67,7	16.585 / 99,1	10.494 / 67,7	15.748 / 99,1	11.342 / 67,7	17.004 / 99,1	19,0

Alle Lumenangaben für 4000K, CRI>80, Gehäusefarbe weiß  
 All lumen values for 4000K, CRI>80, housing colour white  
 Toutes les données de lumens pour 4000K, CRI>80, couleur du boîtier blanc

# SQUARE90

ANBAULEUCHTE | SURFACE MOUNTED LUMINAIRE | LUMINAIRE EN SAILLIE



**Quadratische LED-Flächenleuchte zur Anbaumontage.** Direktstrahlend oder direkt-indirektstrahlend. Gehäuse aus Aluminiumprofil, nahtlos verschweißt. Fertigung der Leuchte in vier Größen: 350, 450, 650 und 950 mm mit einer Gesamthöhe von 90 mm. Oberfläche pulverbeschichtet feinstruktur matt ähnlich RAL 9016 weiß, RAL 9006 silber oder RAL 9005 schwarz – auf Anfrage in RAL nach Wahl. Die durchdachte Konstruktion der Leuchte ermöglicht ein Design in zahlreichen Farbkombinationen – zwischen Gehäusefarbe und Dekorring kann beliebig kombiniert werden. Um der Leuchtenfamilie neben den Standardfarben einen dekorativen Touch zu verleihen, steht der Dekorring auch in den strukturierten Spezialoberflächen schlaggold, schlagsilber und schlagbronze zur Auswahl. Diffuser in PMMA wahlweise opal, mikroprismatisch inkl. Streufolie oder nur mikroprismatisch (office special) für eine reduzierte Leuchtdichte (UGR<19). Einfache Montage durch Einschieben des Leuchtengehäuses in den Baldachin. Der LED-Treiber ist im Leuchtengehäuse integriert – wahlweise als on/off oder DALI-Variante. Farbtemperaturen 2700K, 3000K, 4000K oder dynamisch Weiß (2700K–6500K) – Farbwiedergabe CRI>80 oder CRI>90 – Mac Adam ≤3. Weitere Steuerungsoptionen oder Lichtfarben auf Anfrage möglich. Außerdem ist die Integration vieler Komponenten, wie beispielsweise Notlicht oder Sensortechnologie, sowie eine Vielzahl weiterer Optionen möglich.

**Square surface mounted LED luminaire.** Direct beam or direct-indirect beam. Housing made of aluminium profile, seamlessly welded. Luminaire manufactured in four sizes: 350, 450, 650 and 950 mm with a total height of 90 mm. Surface powder coated fine structure matt similar to RAL 9016 white, RAL 9006 silver or RAL 9005 black - on request in RAL of choice. The sophisticated construction of the luminaire allows a design in numerous colour combinations - any combination of housing colour and decorative ring is possible. To give the luminaire family a decorative touch in addition to the standard colours, the decorative ring is also available in the structured special surfaces of beaten gold, beaten silver and beaten bronze. Diffuser in PMMA either opal, microprism incl. diffuser foil or only microprism (office special) for reduced luminance (UGR<19). Easy mounting by sliding the luminaire housing into the canopy. The LED driver is integrated in the luminaire housing - either as on/off or DALI version. Colour temperatures 2700K, 3000K, 4000K or dynamic white (2700K-6500K) - colour rendering CRI>80 or CRI>90 - Mac Adam ≤3. Further control options or light colours available on request. In addition, the integration of many components, such as emergency lighting or sensor technology, as well as a variety of other options is possible.

**Luminaire carré LED en saillie.** Éclairage direct ou direct-indirect. Boîtier en profilé d'aluminium, soudé sans soudure. Fabrication du luminaire en quatre dimensions : 350, 450, 650 et 950 mm avec une hauteur totale de 90 mm. Surface revêtue par poudre à structure fine mate similaire à RAL 9016 blanc, RAL 9006 argent ou RAL 9005 noir - sur demande en RAL au choix. La construction bien pensée du luminaire permet un design dans de nombreuses combinaisons de couleurs - il est possible de combiner à volonté entre la couleur du boîtier et l'anneau décoratif. Pour donner à la famille de luminaires une touche décorative en plus des couleurs standard, l'anneau décoratif est également disponible dans les surfaces spéciales structurées or choc, argent choc et bronze choc. Diffuseur en PMMA au choix opale, microprismatique y compris film diffusant ou uniquement microprismatique (office special) pour un éblouissement réduit (UGR<19). Montage facile en insérant le corps du luminaire dans le canopy. Le driver LED est intégré dans le boîtier du luminaire - au choix en version on/off ou DALI. Températures de couleur 2700K, 3000K, 4000K ou blanc dynamique (2700K-6500K) - Rendu des couleurs CRI>80 ou CRI>90 - Mac Adam ≤3. Autres options de commande ou couleurs de lumière possibles sur demande. En outre, l'intégration de nombreux composants, tels que l'éclairage de secours ou la technologie des capteurs, une multitude d'autres options sont possibles.

## ÜBERSICHT | OVERVIEW | VUE D'ENSEMBLE

### TECHNICAL DATA

2700K / 3000K / 4000K / 2700-6500K

CRI>80 / CRI>90

MacAdam ≤ 3

up to 175 lm/W

on-off / DALI

direct / direct + indirect

opal / microprism / office special (UGR <19)

L80 B10 50.000h



RAL colour of your choice



Integration of Multisensor



Integration of emergency light



Contact us for more options...

### HOUSING COLOUR

schwarz | black | noir  
RAL 9005



silber | silver | argent  
RAL 9006



weiß | white | blanc  
RAL 9016



### DECORATION RING COLOUR

schwarz | black | noir  
RAL 9005



schlaggold | beaten gold | or texturés



silber | silver | argent  
RAL 9006



schlagsilber | beaten silver | argent texturés



weiß | white | blanc  
RAL 9016



schlagbronze | beaten bronze | bronze texturés



**ANBAULEUCHTE „SQ90A“**  
**SURFACE MOUNTED LUMINAIRE “SQ90A”**  
**LUMINAIRE EN SAILLIE « SQ90A »**

Bestellbeispiel | Example order | Exemple de commande  
 350 mm, CRI>90, 4000K, direct, low output on/off, black, beaten gold, microprismmicroprism

**SQ90A-359401-LOBGM**

1 2 3 4 5 6 7 8

**1 GRÖSSE**  
**SIZE**  
**TAILLE**

350 x 350 mm	<b>35</b>
450 x 450 mm	<b>45</b>
650 x 650 mm	<b>65</b>
950 x 950 mm	<b>95</b>

**2 FARBWIEDERGABE**  
**COLOUR RENDERING**  
**RENDU DES COULEURS**

CRI>80	<b>8</b>
CRI>90	<b>9</b>

**3 FARBTEMPERATUR**  
**COLOUR TEMPERATURE**  
**TEMPÉRATURE DE COULEUR**

2700K (CRI>90 only)	<b>27</b>
3000K	<b>30</b>
4000K	<b>40</b>
2700-6500K (CRI>90 only)	<b>DW</b>

**4 LICHTVERTEILUNG**  
**LIGHT DISTRIBUTION**  
**DISTRIBUTION DE LA LUMIÈRE**

direct	<b>1</b>
direct + indirect	<b>2</b>

**5 LEISTUNG & STEUERUNG**  
**OUTPUT & CONTROL**  
**SORTIE & CONTRÔLE**

low output on/off	<b>LO</b>
low output DALI	<b>LD</b>
high output on/off	<b>HO</b>
high output DALI	<b>HD</b>
dynamic white DALI DT8	<b>DW</b>

**6 GEHÄUSEFARBE**  
**HOUSING COLOUR**  
**COULEUR DU BOÎTIER**

black RAL 9005	<b>B</b>
silver RAL 9006	<b>S</b>
white RAL 9016	<b>W</b>

**7 DEKORRING FARBE**  
**DECORATION RING COLOUR**  
**BAGUE DÉCORATIVE COULEUR**

black RAL 9005	<b>B</b>
silver RAL 9006	<b>S</b>
white RAL 9016	<b>W</b>
beaten gold	<b>G</b>
beaten silver	<b>A</b>
beaten bronze	<b>C</b>

**8 DIFFUSOR**  
**DIFFUSER**  
**DIFFUSEUR**

opal	<b>O</b>
microprism	<b>M</b>
office special	<b>B</b>

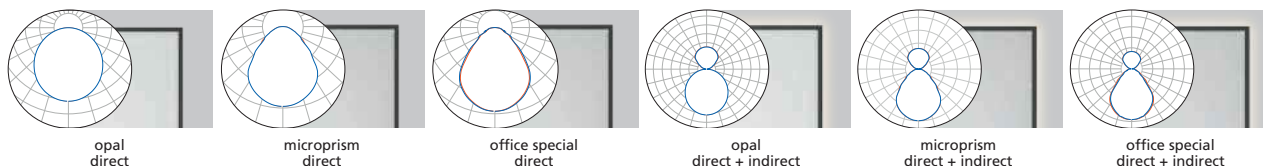
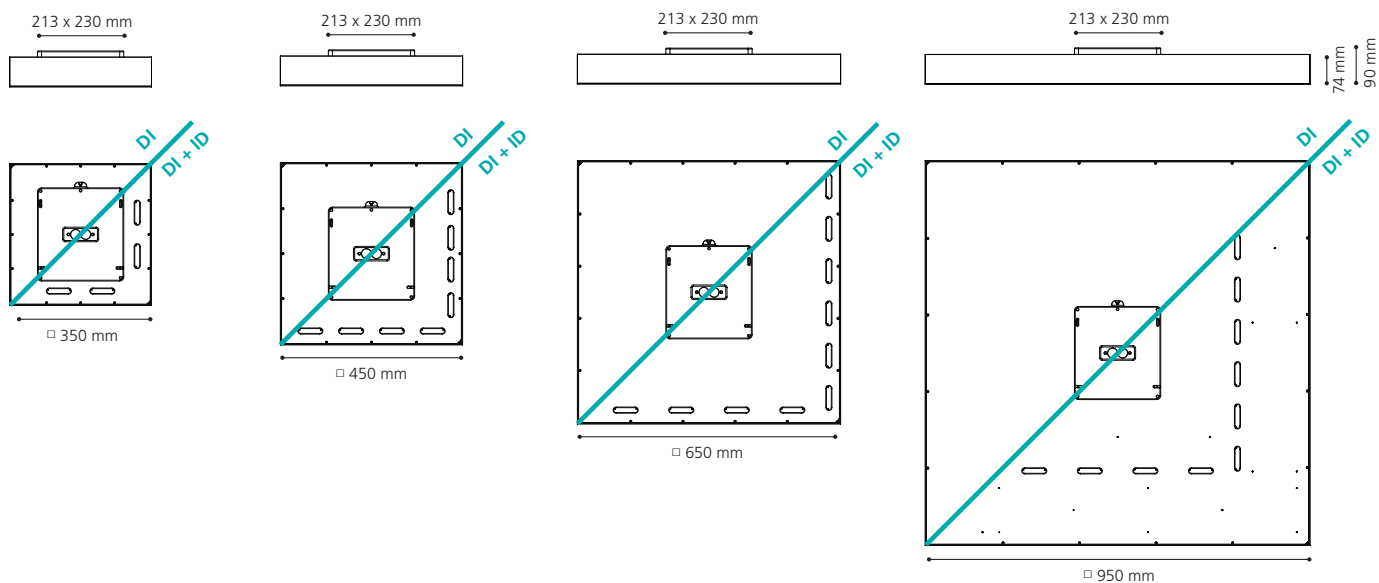

Size [mm]	opal direct		microprism direct		office special direct		opal direct + indirect		microprism direct + indirect		office special direct + indirect		[kg]
	low output [lm] / [W]	high output [lm] / [W]	low output [lm] / [W]	high output [lm] / [W]	low output [lm] / [W]	high output [lm] / [W]	low output [lm] / [W]	high output [lm] / [W]	low output [lm] / [W]	high output [lm] / [W]	low output [lm] / [W]	high output [lm] / [W]	
□ 350	1.349 / 9,9	2.365 / 16,7	1.256 / 9,9	2.208 / 16,7	1.402 / 9,9	2.470 / 16,7	2.029 / 13,8	3.488 / 23,1	1.923 / 13,8	3.308 / 23,1	2.081 / 13,8	3.579 / 23,1	3,9
□ 450	2.288 / 15,4	4.011 / 26,0	2.130 / 15,4	3.744 / 26,0	2.377 / 15,4	4.189 / 26,0	3.236 / 20,7	5.563 / 34,6	3.067 / 20,7	5.276 / 34,6	3.319 / 20,7	5.709 / 34,6	5,4
□ 650	4.711 / 30,5	8.258 / 51,6	4.385 / 30,5	7.708 / 51,6	4.894 / 30,5	8.624 / 51,6	5.845 / 37,0	10.048 / 61,8	5.845 / 37,0	9.530 / 61,8	5.995 / 37,0	10.312 / 61,8	9,3
□ 950	9.868 / 60,9	17.299 / 102,8	9.187 / 60,9	16.148 / 102,8	10.252 / 60,9	18.067 / 102,8	10.918 / 67,4	18.770 / 112,6	10.348 / 67,4	17.801 / 112,6	11.198 / 67,4	19.262 / 112,6	23,4

Aller Lumenangaben für 4000K, CRI>80, Gehäusefarbe weiß  
 All lumen values for 4000K, CRI>80, housing colour white  
 Toutes les données de lumens pour 4000K, CRI>80, couleur du boîtier blanc



# techDOT150surface

DOWNLIGHT | DOWNLIGHT | DOWNLIGHT



**Runder LED-Anbaudownlight** direktstrahlend. Leuchte aus Aluminium-Druckguss mit einem Durchmesser von 151 mm und einer Höhe von 200 mm. Oberfläche der Leuchte feinstruktur matt pulverbeschichtet ähnlich RAL 9016 weiß oder ähnlich RAL 9005 schwarz. Das Baukastensystem ermöglicht das Auswählen von zwei unterschiedlichen Reflektor-Farben: silber-matt oder schwarz-matt für eine reduzierte Leuchtdichte (UGR<19). Der LED-Treiber ist im Leuchtgehäuse integriert – wahlweise als on/off Variante oder als DALI-Variante mit verschiedenen Leistungsstufen. Farbtemperaturen 3000K oder 4000K – Farbwiedergabe CRI>90 – Mac Adam ≤3. Weitere Optionen und Konfigurationen auf Anfrage möglich.

**Round surface mounted LED downlight** direct beam. Luminaire made of die-cast aluminium with a diameter of 151 mm and a height of 200 mm. Surface of the luminaire fine structure matt powder coated similar to RAL 9016 white or similar to RAL 9005 black. The modular system allows the selection of two different reflector colours: matt silver or matt black for reduced luminance (UGR<19). The LED driver is integrated in the luminaire housing - either as an on/off version or as a DALI version with different power levels. Colour temperatures 3000K or 4000K - colour rendering CRI>90 - Mac Adam ≤3. Further options and configurations available on request.

**Luminaire rond LED en saillie** à éclairage direct. Luminaire en aluminium moulé sous pression d'un diamètre de 151 mm et d'une hauteur de 200 mm. Surface du luminaire revêtue de poudre à structure fine mate similaire à RAL 9016 blanc ou similaire à RAL 9005 noir. Le système modulaire permet de choisir entre deux couleurs de réflecteur différentes : argent mat ou noir mat un éblouissement réduit (UGR<19). Le pilote LED est intégré dans le boîtier du luminaire - au choix en version on/off ou en version DALI avec différents niveaux de puissance. Températures de couleur 3000K ou 4000K - Rendu des couleurs CRI>90 - Mac Adam ≤3. Autres options et configurations possibles sur demande.

## ÜBERSICHT | OVERVIEW | VUE D'ENSEMBLE

### TECHNICAL DATA

3000K / 4000K

CRI>90

MacAdam ≤ 3

on-off / DALI

beam angle: 60°



230V AC



LED



>50,000h



3 SDCM



IP 20



CE



UK CA



Contact us for more options...

### HOUSING COLOUR

schwarz | black | noir  
RAL 9005



weiß | white | blanc  
RAL 9016



### REFLECTOR COLOUR

silber matt | silver matt | argenté mat



schwarz matt | black matt | noir mat



**DOWNLIGHT „techDOT150surface“**  
 DOWNLIGHT “techDOT150surface”  
 DOWNLIGHT « techDOT150surface »

Bestellbeispiel | Example order | Exemple de commande  
 60°, CRI>90, 4000K, **direct**, low output on/off, black, silver matt

**TD15A-609401-LOBLM**

1 2 3 4

<b>1</b>	<b>FARBTEMPERATUR</b>	
	COLOUR TEMPERATURE	
	TEMPÉRATURE DE COULEUR	
	3000K	<b>30</b>
	4000K	<b>40</b>

<b>2</b>	<b>LEISTUNG &amp; STEUERUNG</b>	
	OUTPUT & CONTROL	
	SORTIE & CONTRÔLE	
	low output on/off	<b>LO</b>
	high output on/off	<b>HO</b>
	high output DALI	<b>HD</b>

<b>3</b>	<b>GEHÄUSEFARBE</b>	
	HOUSING COLOUR	
	COULEUR DU BOÎTIER	
	white RAL 9016	<b>WH</b>
	black RAL 9005	<b>BL</b>

<b>4</b>	<b>REFLEKTOR FARBE</b>	
	REFLECTOR COLOUR	
	COULEUR DU RÉFLECTEUR	
	silver matt	<b>M</b>
	black matt	<b>B</b>

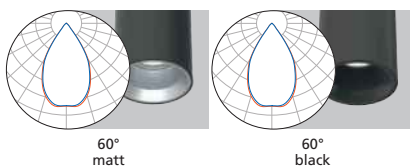
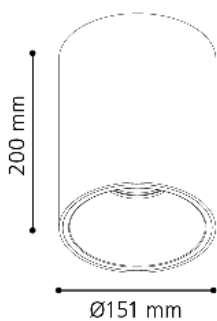

Size [mm]	low output [lm] / [W]	high output [lm] / [W]	low output [lm] / [W]	high output [lm] / [W]	 [kg]
Ø 151	1.333 / 15,5	2.135 / 25,0	1.277 / 15,5	2.085 / 25,0	2,2

Alle Lumenangaben für 4000K  
 All lumen values for 4000K  
 Toutes les données de lumens pour 4000K

# OVERVIEW

## HÄNGELEUCHTEN | PENDANT LUMINAIRES | SUSPENSIONS



LINE40  
**146**



LINE50  
**148**



LINE50hex  
**150**

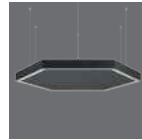

LINE50HEXmute  
**152**



LINE50quad  
**154**



LINE50QUADmute  
**156**



LINE50splash  
**158**



officeLINE50  
**160**

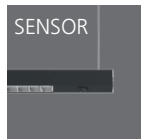

officeLINE50  
**162**



LINE70  
**164**



RING50  
**166**



RING50mute  
**168**



FLEX50  
**170**



OVOID50  
**172**



ROUND90  
**174**



SQUARE90  
**176**



ROPE22  
**178**

# HÄNGELEUCHTEN

PENDANT LUMINAIRES

*SUSPENSIONS*

# LINE40

HÄNGELEUCHE | PENDANT LUMINAIRE | LUMINAIRE SUSPENSION

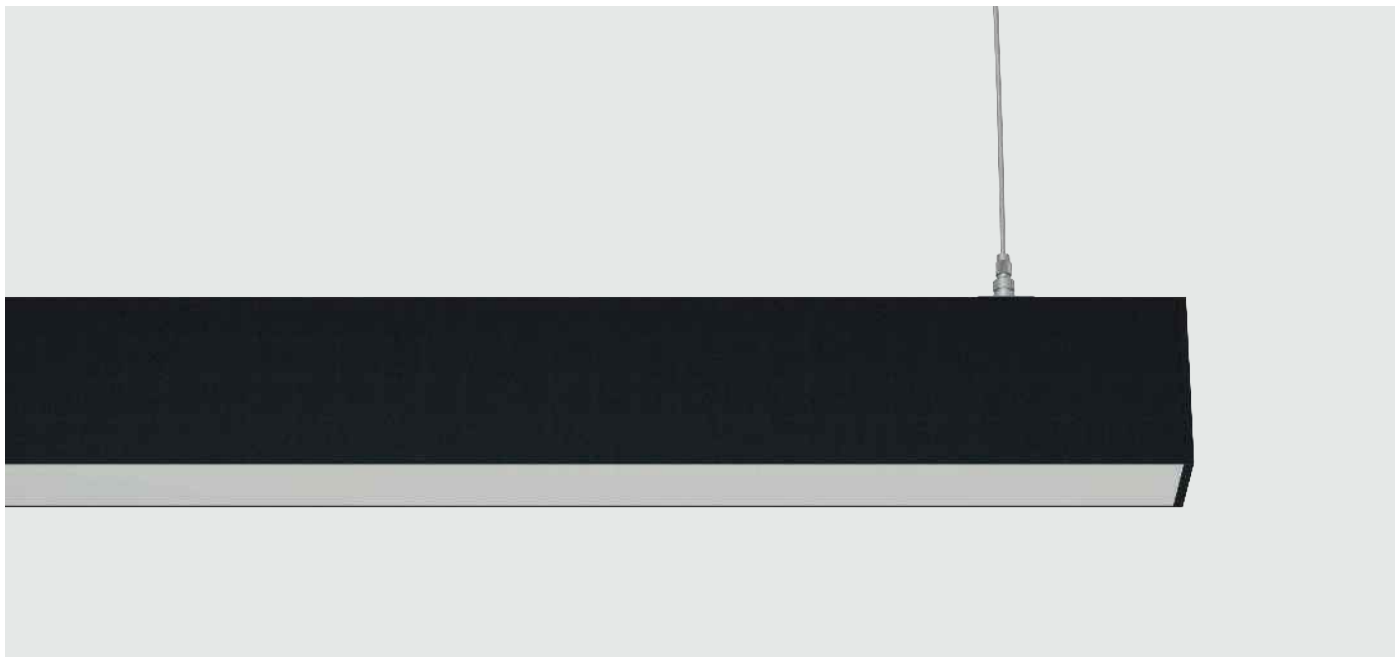

**LED-Hängeleuchte** direktstrahlend oder direkt-indirektstrahlend. Lichtkanal aus Aluminium-Strangpressprofil mit einer Breite von 41 mm. Fertigung der Leuchtenlänge millimetergenau auf Kundenwunsch möglich. Oberfläche der Leuchte feinstruktur matt pulverbeschichtet ähnlich RAL 9016 weiß, RAL 9006 silber oder RAL 9005 schwarz – auf Anfrage in RAL nach Wahl. Diffusor wahlweise in PMMA opal, PMMA opal U-Abdeckung oder PMMA klar mit eingeschobener mikroprismatischer Platte für eine reduzierte Leuchtdichte (UGR<19). Leuchte inkl. weißem, rechteckigem Baldachin mit transparentem Einspeisekabel sowie flexiblen Seilabhängern und Schnellspannern zur stufenlosen Regulierung der Montagehöhe. Der LED- Treiber ist im Leuchtengehäuse integriert – wahlweise als on/off oder DALI-Variante. Farbtemperaturen 2700K, 3000K, 4000K oder dynamisch Weiß (2700K-6500K) – Farbwiedergabe CRI>80 oder CRI>90 – Mac Adam ≤3. Weitere Steuerungsoptionen oder Lichtfarben auf Anfrage erhältlich. Außerdem ist die Integration vieler Komponenten, wie beispielsweise Notlicht oder Sensortechnologie, sowie eine Vielzahl weiterer Optionen möglich.

**Pendant LED luminaire** direct beam or direct-indirect beam. Light channel made of extruded aluminium profile with a width of 41 mm. Luminaire length can be manufactured to the exact millimetre on customer request. Surface of the luminaire fine structure matt powder coated similar to RAL 9016 white, RAL 9006 silver or RAL 9005 black - on request in RAL of choice. Diffuser either in PMMA opal, PMMA opal U-cover or PMMA clear with inserted microprismatic plate for reduced luminance (UGR<19). Luminaire incl. white, rectangular canopy with transparent feeding cable as well as flexible cord suspensions and quick-release clamps for continuous adjustment of mounting height. The LED driver is integrated in the luminaire housing - either as on/off or DALI version. Colour temperatures 2700K, 3000K, 4000K or dynamic white (2700K-6500K) - colour rendering CRI>80 or CRI>90 - Mac Adam ≤3. Further control options or light colours available on request. In addition, the integration of many components, such as emergency lighting or sensor technology, as well as a variety of other options is possible.

**Suspension LED** à éclairage direct ou direct-indirect. Canal lumineux en profilé d'aluminium extrudé d'une largeur de 41 mm. Fabrication de la longueur du luminaire au millimètre près possible sur demande du client. Surface du luminaire à structure fine, revêtement par poudre mat similaire à RAL 9016 blanc, RAL 9006 argent ou RAL 9005 noir - sur demande en RAL au choix. Diffuseur au choix en PMMA opale, PMMA opale cache U ou PMMA transparent avec plaque microprismatique insérée pour un éblouissement réduit (UGR<19). Luminaire avec rosace rectangulaire blanche, câble d'alimentation transparent, câble flexibles et tendeurs rapides permettant de régler la hauteur en continu. Le pilote LED est intégré dans le boîtier du luminaire - au choix sous forme de variante on/off ou DALI. Températures de couleur 2700K, 3000K, 4000K ou blanc dynamique (2700K-6500K) - Rendu des couleurs CRI>80 ou CRI>90 - Mac Adam ≤3. Autres options de commande ou couleurs de lumière disponibles sur demande. En outre, l'intégration de nombreux composants, tels que l'éclairage de secours ou des capteurs, une multitude d'autres options sont possibles.

## ÜBERSICHT | OVERVIEW | VUE D'ENSEMBLE

### TECHNICAL DATA

2700K / 3000K / 4000K / 2700-6500K

CRI>80 / CRI>90

MacAdam ≤ 3

up to 142 lm/W, up to 6.245 lm/m

on-off / DALI

direct / direct + indirect

opal / U-cover / microprism (UGR<19)

L80 B10 50.000h

### HOUSING COLOUR

schwarz | black | noir  
RAL 9005

silber | silver | argent  
RAL 9006

weiß | white | blanc  
RAL 9016



RAL colour of your choice



Integration of Multisensor



Welded mitre cuts



Integration of emergency light



Design Cables



Contact us for more options...

**HÄNGELEUCHTE „LINE40“**  
 PENDANT LUMINAIRE “LINE40”  
 LUMINAIRE SUSPENSION « LINE40 »

Bestellbeispiel | Example order | Exemple de commande  
 3.132 mm, CRI>90, 4000K, direct + indirect, low output on/off, black, microprism

**LI40H-319402-LOBLM**

1 2 3 4 5 6 7

**1 LÄNGE**  
 LENGTH  
 LONGEUR

1.212 mm	12
1.452 mm	14
1.692 mm	16
1.932 mm	19
2.172 mm	21
2.412 mm	24
2.892 mm	28
3.132 mm	31
3.854 mm	38

**2 FARBWIEDERGABE**  
 COLOUR RENDERING  
 RENDU DES COULEURS

CRI>80	8
CRI>90	9

**3 FARBTTEMPERATUR**  
 COLOUR TEMPERATURE  
 TEMPÉRATURE DE COULEUR

2700K (CRI>90 only)	27
3000K	30
4000K	40
2700-6500K (CRI>90 only)	DW

**4 LICHTVERTEILUNG**  
 LIGHT DISTRIBUTION  
 DISTRIBUTION DE LA LUMIÈRE

direct	1
direct + indirect	2

**5 LEISTUNG & STEUERUNG**  
 OUTPUT & CONTROL  
 SORTIE & CONTRÔLE

low output on/off	LO
low output DALI	LD
high output on/off	HO
high output DALI	HD
dynamic white DALI DT8	DW

**6 GEHÄUSEFARBE**  
 HOUSING COLOUR  
 COULEUR DU BOÎTIER

silver RAL 9006	SI
white RAL 9016	WH
black RAL 9005	BL

**7 DIFFUSOR**  
 DIFFUSER  
 DIFFUSEUR

opal	O
microprism	M
U-cover (direct only)	U

direct

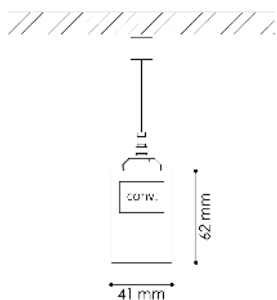

direct U-cover

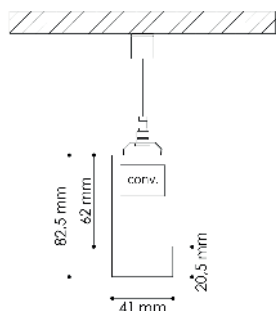

direct + indirect

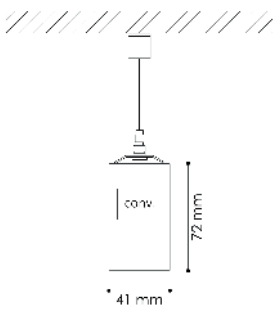

opal direct

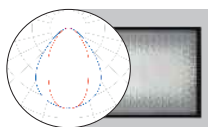

microprism direct

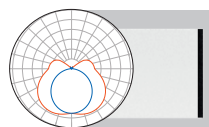

U-cover direct



opal direct + indirect

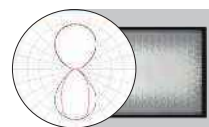

microprism direct + indirect

Size [mm]	direct		direct + indirect		direct		direct + indirect		direct [kg]	direct + indirect [kg]
	low output [lm] / [W]	high output [lm] / [W]	low output [lm] / [W]	high output [lm] / [W]	low output [lm] / [W]	high output [lm] / [W]	low output [lm] / [W]	high output [lm] / [W]		
1.212	1.777 / 16,3	3.150 / 30,0	1.854 / 16,3	3.286 / 30,0	1.828 / 16,3	3.241 / 30,0	3.845 / 29,1	7.336 / 57,2	2,6	3,4
1.452	2.010 / 18,5	3.763 / 35,8	2.097 / 18,5	3.925 / 35,8	2.068 / 18,5	3.871 / 35,8	4.615 / 34,5	8.803 / 68,1	3,2	4,2
1.692	2.398 / 21,2	4.470 / 41,1	2.501 / 21,2	4.663 / 41,1	2.467 / 21,2	4.599 / 41,1	5.384 / 39,5	10.270 / 80,8	3,7	4,8
1.932	2.779 / 23,7	5.222 / 46,3	2.889 / 23,7	5.448 / 46,3	2.859 / 23,7	5.373 / 46,3	6.154 / 44,6	11.738 / 91,7	4,2	5,5
2.172	3.157 / 26,6	5.931 / 52,0	3.293 / 26,6	6.187 / 52,0	3.248 / 26,6	6.102 / 52,0	6.923 / 50,0	13.205 / 103,0	4,7	6,1
2.412	3.441 / 29,2	6.544 / 57,3	3.590 / 29,2	6.826 / 57,3	3.541 / 29,2	6.732 / 57,3	7.690 / 56,0	14.672 / 113,0	5,3	6,8
2.892	3.880 / 34,3	7.570 / 69,6	4.048 / 34,3	7.897 / 69,6	3.992 / 34,3	7.788 / 69,6	9.230 / 67,0	17.606 / 135,0	6,4	8,2
3.132	4.326 / 36,9	8.516 / 75,5	4.513 / 36,9	8.884 / 75,5	4.451 / 36,9	8.761 / 75,5	9.999 / 72,3	19.074 / 145,3	6,8	8,9
3.854	5.558 / 47,4	10.444 / 92,6	5.798 / 47,4	10.896 / 92,6	5.718 / 47,4	10.746 / 92,6	12.308 / 89,2	23.476 / 183,4	8,5	11,1

Alle Lumenangaben für 4000K, CRI>80, Microprisma ohne Opalfolie  
 All lumen values for 4000K, CRI>80, microprism without opal foil  
 Toutes les données de lumens pour 4000K, CRI>80, microprisme sans feuille opale



# LINE50

HÄNGELEUCHE | PENDANT LUMINAIRE | LUMINAIRE SUSPENSION

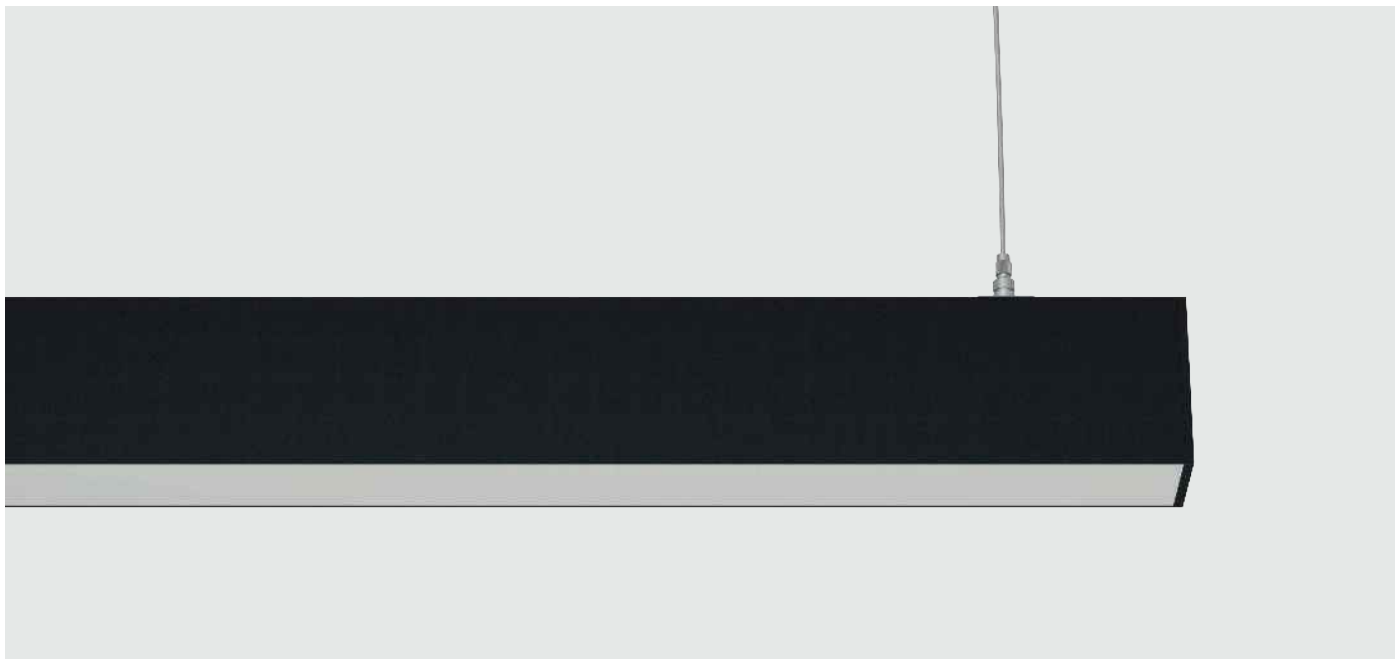

**LED-Hängeleuchte** direktstrahlend oder direkt-indirektstrahlend. Lichtkanal aus Aluminium-Strangpressprofil mit einer Breite von 50 mm. Fertigung der Leuchtenlänge millimetergenau auf Kundenwunsch möglich. Oberfläche der Leuchte feinstruktur matt pulverbeschichtet ähnlich RAL 9016 weiß, RAL 9006 silber oder RAL 9005 schwarz – auf Anfrage in RAL nach Wahl. Diffusor wahlweise in PMMA opal, PMMA klar mit eingeschobener asymmetrischer Folie oder PMMA klar mit eingeschobener mikroprismatischer Platte für eine reduzierte Leuchtdichte (UGR<19). Leuchte inkl. weißem, rechteckigem Baldachin mit transparentem Einspeisekabel sowie flexiblen Seilabhängern und Schnellspannern zur stufenlosen Regulierung der Montagehöhe. Der LED-Treiber ist im Leuchtgehäuse integriert – wahlweise als on/off oder DALI-Variante – Farbtemperaturen 2700K, 3000K, 4000K oder dynamisch Weiß (2700K–6500K) – Farbwiedergabe CRI>80 oder CRI>90 – Mac Adam ≤3. Weitere Steuerungsoptionen oder Lichtfarben auf Anfrage erhältlich. Außerdem ist die Integration vieler Komponenten, wie beispielsweise Notlicht oder Sensortechnologie, sowie eine Vielzahl weiterer Optionen möglich.

**Pendant LED luminaire** direct beam or direct-indirect beam. Light channel made of extruded aluminium profile with a width of 50 mm. Luminaire length can be manufactured to the exact millimetre on customer request. Surface of the luminaire fine structure matt powder coated similar to RAL 9016 white, RAL 9006 silver or RAL 9005 black - on request in RAL of choice. Diffuser either in PMMA opal, PMMA clear with inserted asymmetric foil or PMMA clear with inserted microprismatic plate for reduced luminance (UGR<19). Luminaire incl. white, rectangular canopy with transparent feeding cable as well as flexible cord suspensions and quick-release clamps for continuous adjustment of mounting height. The LED driver is integrated in the luminaire housing - either as on/off or DALI version - colour temperatures 2700K, 3000K, 4000K or dynamic white (2700K-6500K) - colour rendering CRI>80 or CRI>90 - Mac Adam ≤3. Further control options or light colours available on request. In addition, the integration of many components, such as emergency lighting or sensor technology, as well as a variety of other options is possible.

**Suspension LED** à éclairage direct ou direct-indirect. Canal lumineux en profilé d'aluminium extrudé d'une largeur de 50 mm. Fabrication de la longueur du luminaire au millimètre près possible sur demande du client. Surface du luminaire à structure fine, revêtement par poudre mat similaire à RAL 9016 blanc, RAL 9006 argent ou RAL 9005 noir - sur demande en RAL au choix. Diffuseur au choix en PMMA opale, PMMA transparent avec feuille asymétrique insérée ou PMMA transparent avec plaque microprismatique insérée pour un éblouissement réduit (UGR<19). Luminaire comprenant un abat-jour rectangulaire blanc avec câble d'alimentation transparent ainsi que des câbles flexibles et des tendeurs rapides permettant de régler la hauteur de montage en continu. Le pilote LED est intégré dans le boîtier du luminaire - au choix sous forme de variante on/off ou DALI - températures de couleur 2700K, 3000K, 4000K ou blanc dynamique (2700K-6500K) - rendu des couleurs CRI>80 ou CRI>90 - Mac Adam ≤3. Autres options de commande ou couleurs de lumière disponibles sur demande. En outre, l'intégration de nombreux composants, tels que l'éclairage de secours ou la technologie de détection, une multitude d'autres options sont possibles.

## ÜBERSICHT | OVERVIEW | VUE D'ENSEMBLE

### TECHNICAL DATA

2700K / 3000K / 4000K / 2700-6500K

CRI>80 / CRI>90

MacAdam ≤ 3

up to 149 lm/W, up to 6.554 lm/m

on-off / DALI

direct / direct + indirect

opal / microprism (UGR <19) / asymmetric

L80 B10 50.000h

### HOUSING COLOUR

schwarz | black | noir  
RAL 9005

silber | silver | argent  
RAL 9006

weiß | white | blanc  
RAL 9016



RAL colour of your choice



Integration of 3-phase-track



Integration of Multisensor



Welded mitre cuts



Integration of emergency light



Integration of GLOWmini/  
GLOWsmall series



Design Cables



Contact us for more options...

**HÄNGELEUCHTE „LINE50“**  
 PENDANT LUMINAIRE “LINE50”  
 LUMINAIRE SUSPENSION « LINE50 »

Bestellbeispiel | Example order | Exemple de commande  
 3.134 mm, CRI>90, 4000K, direct + indirect, low output on/off, black, microprism

**LI50H-319402-LOBLM**

1 2 3 4 5 6 7

1 LÄNGE LENGTH LONGEUR	
1.214 mm	12
1.454 mm	14
1.694 mm	16
1.934 mm	19
2.174 mm	21
2.414 mm	24
2.894 mm	28
3.134 mm	31
3.856 mm	38

2 FARBWIEDERGABE COLOUR RENDERING RENDU DES COULEURS	
CRI>80	8
CRI>90	9

3 FARBTemperatur COLOUR TEMPERATURE TEMPÉRATURE DE COULEUR	
2700K (CRI>90 only)	27
3000K	30
4000K	40
2700-6500K (CRI>90 only)	DW

4 LICHTVERTEILUNG LIGHT DISTRIBUTION DISTRIBUTION DE LA LUMIÈRE	
direct	1
direct + indirect	2

5 LEISTUNG & STEUERUNG OUTPUT & CONTROL SORTIE & CONTRÔLE	
low output on/off	LO
low output DALI	LD
high output on/off	HO
high output DALI	HD
dynamic white DALI DT8	DW

6 GEHÄUSEFARBE HOUSING COLOUR COULEUR DU BOÎTIER	
silver RAL 9006	SI
white RAL 9016	WH
black RAL 9005	BL

7 DIFFUSOR DIFFUSER DIFFUSEUR	
opal	O
microprism	M
asymmetric	A

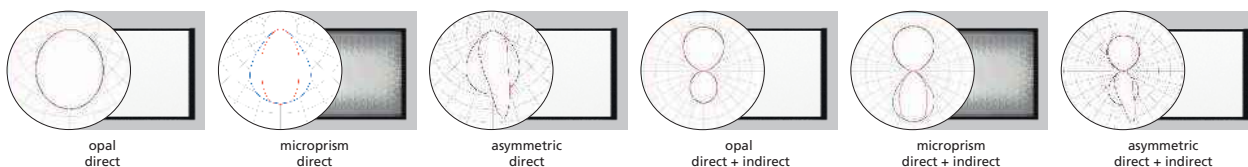
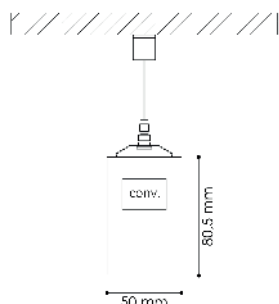

Size [mm]	opal direct		microprism direct		asymmetric direct		opal direct + indirect		microprism direct + indirect		asymmetric direct + indirect		direct	direct + indirect
	low output [lm] / [W]	high output [lm] / [W]	low output [lm] / [W]	high output [lm] / [W]	low output [lm] / [W]	high output [lm] / [W]	low output [lm] / [W]	high output [lm] / [W]	low output [lm] / [W]	high output [lm] / [W]	low output [lm] / [W]	high output [lm] / [W]	kg	kg
1.214	1.818 / 16,3	3.463 / 30,0	1.652 / 16,3	3.162 / 30,0	1.850 / 16,3	3.541 / 30,0	4.120 / 29,1	7.898 / 57,0	3.845 / 29,1	7.336 / 57,2	4.076 / 29,1	7.776 / 57,2	2,9	3,6
1.454	2.182 / 18,5	4.156 / 35,8	1.982 / 18,5	3.794 / 35,8	2.220 / 18,5	4.249 / 35,8	4.944 / 34,5	9.477 / 68,0	4.615 / 34,5	8.803 / 68,1	4.892 / 34,5	9.331 / 68,1	3,5	4,4
1.694	2.546 / 21,2	4.848 / 41,1	2.313 / 21,2	4.427 / 41,1	2.591 / 21,2	4.958 / 41,1	5.769 / 39,5	11.057 / 81,0	5.384 / 39,5	10.270 / 80,8	5.707 / 39,5	10.886 / 80,8	4,1	5,1
1.934	2.911 / 23,7	5.541 / 46,3	2.642 / 23,7	5.059 / 46,3	2.959 / 23,7	5.666 / 46,3	6.592 / 44,6	12.636 / 92,0	6.154 / 44,6	11.738 / 91,7	6.523 / 44,6	12.442 / 91,7	4,6	5,8
2.174	3.273 / 26,6	6.233 / 52,0	2.974 / 26,6	5.692 / 52,0	3.331 / 26,6	6.375 / 52,0	7.416 / 49,9	14.217 / 103,0	6.923 / 49,9	13.205 / 103,0	7.338 / 49,9	13.997 / 103,0	5,2	6,5
2.414	3.635 / 29,2	6.926 / 57,3	3.304 / 29,2	6.324 / 57,3	3.700 / 29,2	7.083 / 57,3	8.240 / 56,0	15.796 / 113,0	7.690 / 56,0	14.672 / 113,1	8.151 / 56,0	15.552 / 113,1	5,8	7,2
2.894	4.364 / 34,3	8.311 / 69,6	3.964 / 34,3	7.589 / 69,6	4.440 / 34,3	8.500 / 69,6	9.889 / 67,0	18.955 / 135,0	9.230 / 67,0	17.606 / 134,8	9.784 / 67,0	18.662 / 134,8	7,0	8,7
3.134	4.728 / 36,9	9.004 / 75,5	4.295 / 36,9	8.221 / 75,5	4.810 / 36,9	9.208 / 75,5	10.712 / 72,3	20.534 / 145,0	9.999 / 72,3	19.074 / 145,3	10.599 / 72,3	20.218 / 145,3	7,5	9,4
3.856	5.821 / 47,4	11.082 / 92,6	5.284 / 47,4	10.118 / 92,6	5.918 / 47,4	11.332 / 92,6	13.183 / 89,2	25.273 / 183,0	12.308 / 89,2	23.476 / 183,4	13.046 / 89,2	24.885 / 183,4	9,3	11,7

Alle Lumenangaben für 4000K, CRI>80, Microprisma ohne Opalfolie  
 All lumen values for 4000K, CRI>80, microprism without opal foil  
 Toutes les données de lumens pour 4000K, CRI>80, microprisme sans feuille opale

# LINE50hex

HÄNGELEUCHE | PENDANT LUMINAIRE | LUMINAIRE SUSPENSION



**LED-Hängeleuchte** direktstrahlend oder direkt-indirektstrahlend. Lichtkanal aus Aluminium-Strangpressprofil mit einer Breite von 50 mm. Leuchte in hexagonaler Form mit verschweißten Ecken – Lieferung der drei Standardgrößen komplett in einem Stück (DM 1306 mm), in zwei Teilen (DM 2028 mm) bzw. sechs gleich großen Teilen (DM 2988 mm). Oberfläche der Leuchte feinstruktur matt pulverbeschichtet ähnlich RAL 9016 weiß, RAL 9006 silber oder RAL 9005 schwarz – auf Anfrage in RAL nach Wahl. Diffusor wahlweise in PMMA opal oder PMMA klar mit eingeschobener mikroprismatischer Platte für eine reduzierte Leuchtdichte (UGR<19). Leuchte inkl. weißem, rechteckigem Baldachin mit transparentem Einspeisekabel sowie flexiblen Seilabhängern und Schnellspannern zur stufenlosen Regulierung der Montagehöhe. Der LED-Treiber ist im Leuchtengehäuse integriert – wahlweise als on/off oder DALI-Variante. Farbtemperaturen 2700K, 3000K, 4000K oder dynamisch Weiß (2700K–6500K) – Farbwiedergabe CRI>80 oder CRI>90 – Mac Adam ≤3. Weitere Steuerungsoptionen oder Lichtfarben auf Anfrage erhältlich. Außerdem ist die Integration vieler Komponenten, wie beispielsweise Notlicht oder Sensortechnologie, sowie eine Vielzahl weiterer Optionen möglich.

**Pendant LED luminaire** direct beam or direct-indirect beam. Light channel made of extruded aluminium profile with a width of 50 mm. Luminaire in hexagonal form with welded corners - delivery of the three standard sizes in one piece (DM 1306 mm), in two pieces (DM 2028 mm) or six equally sized pieces (DM 2988 mm). Surface of the luminaire fine structure matt powder coated similar to RAL 9016 white, RAL 9006 silver or RAL 9005 black - on request in RAL of choice. Diffuser either in PMMA opal or PMMA clear with inserted microprismatic plate for reduced luminance (UGR<19). Luminaire incl. white, rectangular canopy with transparent feeding cable as well as flexible cord suspensions and quick-release clamps for continuous adjustment of mounting height. The LED driver is integrated in the luminaire housing - either as on/off or DALI version. Colour temperatures 2700K, 3000K, 4000K or dynamic white (2700K-6500K) - colour rendering CRI>80 or CRI>90 - Mac Adam ≤3. Further control options or light colours available on request. In addition, the integration of many components, such as emergency lighting or sensor technology, as well as a variety of other options is possible.

**Suspension LED** à éclairage direct ou direct-indirect. Canal lumineux en profilé d'aluminium extrudé d'une largeur de 50 mm. Luminaire de forme hexagonale avec coins soudés - livraison des trois tailles standard complètes en une pièce (DM 1306 mm), en deux pièces (DM 2028 mm) ou en six pièces de taille identique (DM 2988 mm). Surface du luminaire à structure fine matte revêtue par poudre similaire à RAL 9016 blanc, RAL 9006 argent ou RAL 9005 noir - sur demande en RAL au choix. Diffuseur au choix en PMMA opale ou en PMMA transparent avec plaque microprismatique insérée pour un éblouissement réduit (UGR<19). Luminaire rectangulaire blanc avec câble d'alimentation transparent ainsi que des câbles flexibles et des tendeurs rapides permettant de régler la hauteur de montage en continu. Le pilote LED est intégré dans le boîtier du luminaire - au choix sous forme de variante on/off ou DALI. Températures de couleur 2700K, 3000K, 4000K ou blanc dynamique (2700K-6500K) - Rendu des couleurs CRI>80 ou CRI>90 - Mac Adam ≤3. Autres options de commande ou couleurs de lumière disponibles sur demande. En outre, l'intégration de nombreux composants, tels que l'éclairage de secours ou la technologie des capteurs, une multitude d'autres options sont possibles.

## ÜBERSICHT | OVERVIEW | VUE D'ENSEMBLE

### TECHNICAL DATA

2700K / 3000K / 4000K / 2700-6500K

CRI>80 / CRI>90

MacAdam ≤ 3

up to 141 lm/W, up to 6.268 lm/m

on-off / DALI

direct / direct + indirect

opal / microprism (UGR <19)

L80 B10 50.000h

### HOUSING COLOUR

schwarz | black | noir  
RAL 9005

silber | silver | argent  
RAL 9006

weiß | white | blanc  
RAL 9016



RAL colour of your choice



Integration of 3-phase-track



Integration of Multisensor



Welded mitre cuts



Integration of emergency light



Integration of GLOWmini/ GLOWsmall series



Design Cables



Contact us for more options...

**HÄNGELEUCHTE „LINE50hex“**  
 PENDANT LUMINAIRE “LINE50hex”  
 LUMINAIRE SUSPENSION « LINE50hex »

Bestellbeispiel | Example order | Exemple de commande  
 2.988 mm, CRI>90, 4000K, direct + indirect, low output on/off, black, microprism

**LH50H-299402-LOBLM**

1 2 3 4 5 6 7

**1 GRÖSSE**  
 SIZE  
 TAILLE

1.306 mm	<b>13</b>
2.028 mm	<b>20</b>
2.988 mm	<b>29</b>

**2 FARBWIEDERGABE**  
 COLOUR RENDERING  
 RENDU DES COULEURS

CRI>80	<b>8</b>
CRI>90	<b>9</b>

**3 FARBTEMPERATUR**  
 COLOUR TEMPERATURE  
 TEMPÉRATURE DE COULEUR

2700K (CRI>90 only)	<b>27</b>
3000K	<b>30</b>
4000K	<b>40</b>
2700-6500K (CRI>90 only)	<b>DW</b>

**4 LICHTVERTEILUNG**  
 LIGHT DISTRIBUTION  
 DISTRIBUTION DE LA LUMIÈRE

direct	<b>1</b>
direct + indirect	<b>2</b>

**5 LEISTUNG & STEUERUNG**  
 OUTPUT & CONTROL  
 SORTIE & CONTRÔLE

low output on/off	<b>LO</b>
low output DALI	<b>LD</b>
high output on/off	<b>HO</b>
high output DALI	<b>HD</b>
dynamic white DALI DT8	<b>DW</b>

**6 GEHÄUSEFARBE**  
 HOUSING COLOUR  
 COULEUR DU BOÎTIER

silver RAL 9006	<b>SI</b>
white RAL 9016	<b>WH</b>
black RAL 9005	<b>BL</b>

**7 DIFFUSOR**  
 DIFFUSER  
 DIFFUSEUR

opal	<b>O</b>
microprism	<b>M</b>

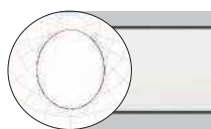
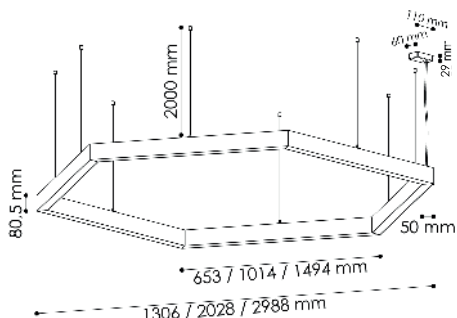

opal direct

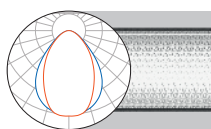

microprism direct

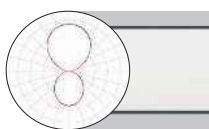

opal direct + indirect

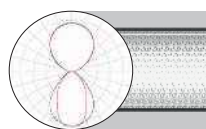

microprism direct + indirect

direct direct + indirect

Size [mm]	opal direct		microprism direct		opal direct + indirect		microprism direct + indirect		direct	direct + indirect
	low output [lm] / [W]	high output [lm] / [W]	low output [lm] / [W]	high output [lm] / [W]	low output [lm] / [W]	high output [lm] / [W]	low output [lm] / [W]	high output [lm] / [W]	kg	kg
1.306	5.454 / 44,9	10.389 / 87,7	4.956 / 44,9	9.486 / 87,7	12.361 / 89,8	23.694 / 175,4	11.538 / 89,8	22.008 / 175,4	9,0	10,8
2.028	8.730 / 67,0	16.619 / 134,8	7.926 / 67,0	15.180 / 134,8	19.776 / 130,6	37.913 / 266,2	18.462 / 130,6	35.214 / 266,2	14,0	18,0
2.988	13.092 / 99,8	24.935 / 206,0	11.892 / 99,8	22.764 / 206,0	29.667 / 195,9	56.864 / 399,3	27.690 / 195,9	52.818 / 399,3	21,0	26,4

Alle Lumenangaben für 4000K, CRI>80, Microprisma ohne Opalfolie

All lumen values for 4000K, CRI>80, microprism without opal foil

Toutes les données de lumens pour 4000K, CRI>80, microprisme sans feuille opale

# LINE50HEXmute

HÄNGELEUCHE | PENDANT LUMINAIRE | LUMINAIRE SUSPENSION



**LED-Hängeleuchte** direktstrahlend oder direkt-indirektstrahlend. Lichtkanal aus Aluminium-Strangpressprofil mit einer Breite von 50 mm. Leuchte in hexagonaler Form mit verschweißten Ecken – Lieferung komplett in einem Stück (DM 1306 mm). Oberfläche der Leuchte feinstruktur matt pulverbeschichtet ähnlich RAL 9016 weiß, RAL 9006 silber oder RAL 9005 schwarz – auf Anfrage in RAL nach Wahl. Akustik-elemente aus recyceltem PET in schwarz, hellgrau meliert, anthrazit meliert, burgunderrot oder olivgrün auswählbar. Diffusor wahlweise in PMMA opal oder PMMA klar mit eingeschobener mikroprismatischer Platte für eine reduzierte Leuchtdichte (UGR<19). Leuchte inkl. weißem, rechteckigem Baldachin mit transparentem Einspeisekabel sowie flexiblen Seilabhängern und Schnellspannern zur stufenlosen Regulierung der Montagehöhe. Der LED-Treiber ist im Leuchtgehäuse integriert – wahlweise als on/off oder DALI-Variante. Farbtemperaturen 2700K, 3000K, 4000K oder dynamisch Weiß (2700K–6500K) – Farbwiedergabe CRI>80 oder CRI>90 – Mac Adam ≤3.

**Pendant LED luminaire** direct beam or direct-indirect beam. Light channel made of extruded aluminium profile with a width of 50 mm. Luminaire in hexagonal form with welded corners - delivery in one piece (DM 1306 mm). Surface of the luminaire fine structure matt powder coated similar to RAL 9016 white, RAL 9006 silver or RAL 9005 black - on request in RAL of choice. Acoustic elements made of recycled PET available in black, light grey mottled, anthracite mottled, burgundy red or olive green. Diffuser either in PMMA opal or PMMA clear with inserted microprismatic plate for reduced luminance (UGR<19). Luminaire incl. white, rectangular canopy with transparent feeding cable as well as flexible cord suspensions and quick-release clamps for continuous adjustment of mounting height. The LED driver is integrated in the luminaire housing - either as on/off or DALI version. Colour temperatures 2700K, 3000K, 4000K or dynamic white (2700K-6500K) - colour rendering CRI>80 or CRI>90 - Mac Adam ≤3.

**Suspension LED** à éclairage direct ou direct-indirect. Canal lumineux en profilé d'aluminium extrudé d'une largeur de 50 mm. Luminaire de forme hexagonale avec coins soudés - livraison en une pièce (DM 1306 mm). Surface du luminaire à structure fine matte revêtue par poudre similaire à RAL 9016 blanc, RAL 9006 argent ou RAL 9005 noir - sur demande en RAL au choix. Éléments acoustiques fabriqués en PET recyclé en noir, gris clair chiné, anthracite chiné, rouge bordeaux ou vert olive au choix. Diffuseur au choix en PMMA opale ou en PMMA transparent avec plaque microprismatique insérée pour un éblouissement réduit (UGR<19). Luminaire rectangulaire blanc avec câble d'alimentation transparent ainsi que des câbles flexibles et des tendeurs rapides permettant de régler la hauteur de montage en continu. Le pilote LED est intégré dans le boîtier du luminaire - au choix sous forme de variante on/off ou DALI. Températures de couleur 2700K, 3000K, 4000K ou blanc dynamique (2700K-6500K) - Rendu des couleurs CRI>80 ou CRI>90 - Mac Adam ≤3.

## ÜBERSICHT | OVERVIEW | VUE D'ENSEMBLE

TECHNICAL DATA
2700K / 3000K / 4000K / 2700-6500K
CRI>80 / CRI>90
MacAdam ≤ 3
up to 138 lm/W, up to 6268 lm/m
on-off / DALI
direct / direct + indirect
opal / microprism (UGR <19)
L80 B10 50.000h
acoustic material - fire classification: B-s2, d0 (EN13501-1:3018)

<p>RAL colour of your choice</p> <p>Contact us for more options...</p>							

HOUSING COLOUR	
schwarz   black   noir RAL 9005	
silber   silver   argent RAL 9006	
weiß   white   blanc RAL 9016	

COLOUR ACOUSTIC PANEL			
schwarz   black   noir		burgunderrot   burgundy red   rouge bourgogne	
hellgrau meliert   light grey mottled   gris clair chiné		olivgrün   olive green   vert olive	
anthrazit meliert   anthracite mottled   anthracite chiné			

**HÄNGELEUCHTE „LINE50HEXmute“**  
 PENDANT LUMINAIRE “LINE50HEXmute”  
 LUMINAIRE SUSPENSION « LINE50HEXmute »

Bestellbeispiel | Example order | Exemple de commande  
 1.306 mm, CRI90, 4000K, direct + indirect, low output on/off, black, olive, microprism

**LH5MH-139402-LOBOM**

1 2 3 4 5 6 7

**1 FARBWIEDERGABE**  
 COLOUR RENDERING  
 RENDU DES COULEURS

CRI>80	<b>8</b>
CRI>90	<b>9</b>

**2 FARBTEMPERATUR**  
 COLOUR TEMPERATURE  
 TEMPÉRATURE DE COULEUR

2700K (CRI>90 only)	<b>27</b>
3000K	<b>30</b>
4000K	<b>40</b>
2700-6500K (CRI>90 only)	<b>DW</b>

**3 LICHTVERTEILUNG**  
 LIGHT DISTRIBUTION  
 DISTRIBUTION DE LA LUMIÈRE

direct	<b>1</b>
direct + indirect	<b>2</b>

**4 LEISTUNG & STEUERUNG**  
 OUTPUT & CONTROL  
 SORTIE & CONTRÔLE

low output on/off	<b>LO</b>
low output DALI	<b>LD</b>
high output on/off	<b>HO</b>
high output DALI	<b>HD</b>
dynamic white DALI DT8	<b>DW</b>

**5 GEHÄUSEFARBE**  
 HOUSING COLOUR  
 COULEUR DU BOÎTIER

silver RAL 9006	<b>S</b>
white RAL 9016	<b>W</b>
black RAL 9005	<b>B</b>

**6 FARBE AKUSTIKPLATTE**  
 COLOUR ACOUSTIC PANEL  
 COULEUR PANNEAU ACOUSTIQUE

black	<b>B</b>
light grey mottled	<b>S</b>
anthracite mottled	<b>A</b>
burgundy red	<b>R</b>
olive green	<b>O</b>

**7 DIFFUSOR**  
 DIFFUSER  
 DIFFUSEUR

opal	<b>O</b>
microprism	<b>M</b>

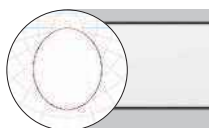
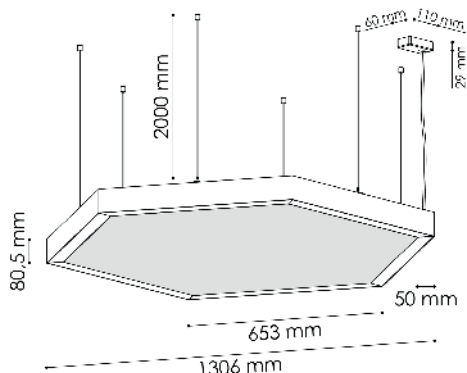

opal  
direct

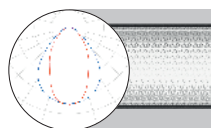

microprism  
direct

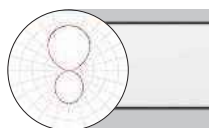

opal  
direct + indirect

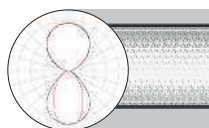

microprism  
direct + indirect

direct

direct +  
indirect

Size [mm]	low output [lm] / [W]		high output [lm] / [W]		low output [lm] / [W]		high output [lm] / [W]		direct [kg]	direct + indirect [kg]
	low output	high output	low output	high output	low output	high output	low output	high output		
1.306	5.454 / 44,9	10.389 / 87,7	4.956 / 44,9	9.486 / 87,7	12.361 / 89,8	23.694 / 175,4	11.538 / 89,8	22.008 / 175,4	12,9	14,6

Alle Lumenangaben für 4000K, CRI>80, Microprisma ohne Opalfolie  
 All lumen values for 4000K, CRI>80, microprism without opal foil  
 Toutes les données de lumens pour 4000K, CRI>80, microprisme sans feuille opale



# LINE50quad

HÄNGELEUCHE | PENDANT LUMINAIRE | LUMINAIRE SUSPENSION

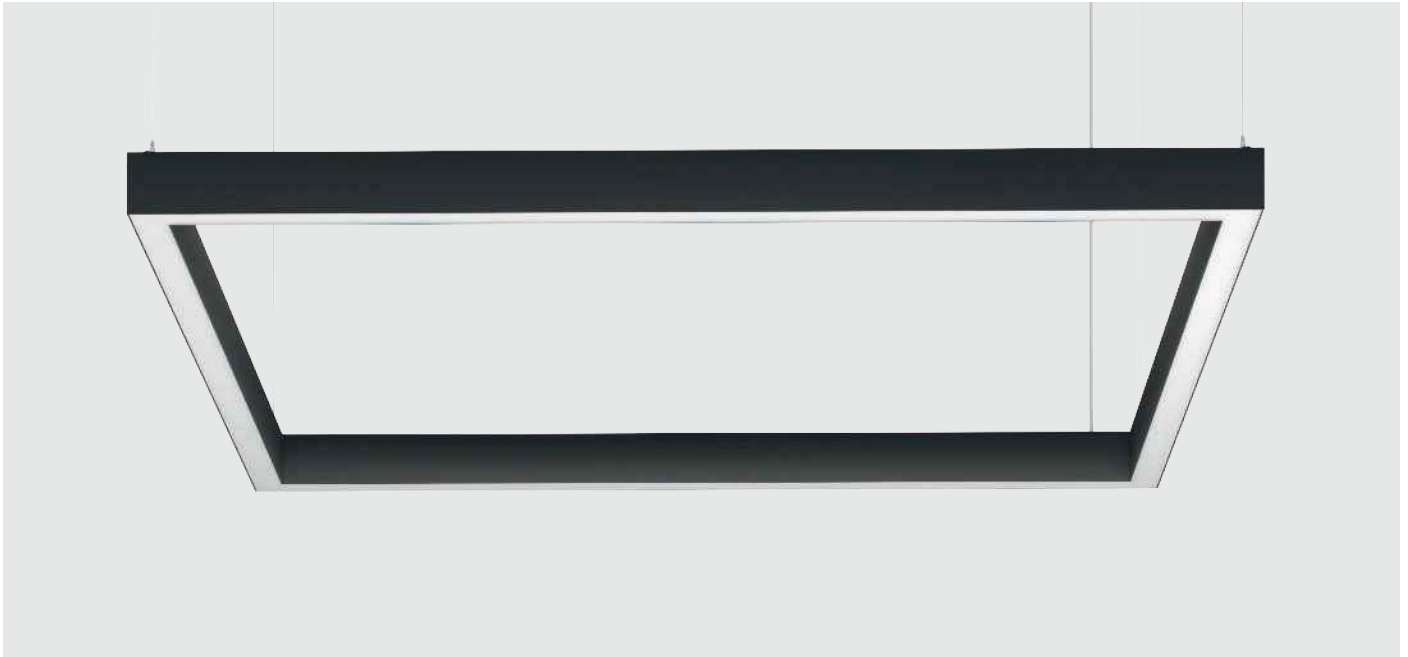

**LED-Hängeleuchte** direktstrahlend oder direkt-indirektstrahlend. Lichtkanal aus Aluminium-Strangpressprofil mit einer Breite von 50 mm. Leuchte in quadratischer Form mit verschweißten Ecken – Lieferung der drei Standardgrößen komplett in einem Stück (660, 1020 mm) bzw. in zwei Teilen (1500 mm). Oberfläche der Leuchte feinstruktur matt pulverbeschichtet ähnlich RAL 9016 weiß, RAL 9006 silber oder RAL 9005 schwarz – auf Anfrage in RAL nach Wahl. Diffusor wahlweise in PMMA opal oder PMMA klar mit eingeschobener mikroprismatischer Platte für eine reduzierte Leuchtdichte (UGR<19). Leuchte inkl. weißem, rechteckigem Baldachin mit transparentem Einspeisekabel sowie flexiblen Seilabhängern und Schnellspannern zur stufenlosen Regulierung der Montagehöhe. Der LED-Treiber ist im Leuchtgehäuse integriert – wahlweise als on/off oder DALI-Variante – Farbtemperaturen 2700K, 3000K, 4000K oder dynamisch Weiß (2700K–6500K) – Farbwiedergabe CRI>80 oder CRI>90 – Mac Adam ≤3. Weitere Steuerungsoptionen oder Lichtfarben auf Anfrage erhältlich. Außerdem ist die Integration vieler Komponenten, wie beispielsweise Notlicht oder Sensortechnologie, sowie eine Vielzahl weiterer Optionen möglich.

**Pendant LED luminaire** direct beam or direct-indirect beam. Light channel made of extruded aluminium profile with a width of 50 mm. Luminaire in square shape with welded corners - delivery of the three standard sizes in one piece (660, 1020 mm) or in two pieces (1500 mm). Surface of the luminaire fine structure matt powder coated similar to RAL 9016 white, RAL 9006 silver or RAL 9005 black - on request in RAL of choice. Diffuser either in PMMA opal or PMMA clear with inserted microprismatic plate for reduced luminance (UGR<19). Luminaire incl. white, rectangular canopy with transparent feeding cable as well as flexible wire suspensions and quick-release fasteners for stepless adjustment of mounting height. The LED driver is integrated in the luminaire housing - either as on/off or DALI version - colour temperatures 2700K, 3000K, 4000K or dynamic white (2700K-6500K) - colour rendering CRI>80 or CRI>90 - Mac Adam ≤3. Further control options or light colours available on request. In addition, the integration of many components, such as emergency lighting or sensor technology, as well as a variety of other options is possible.

**Suspension LED** à éclairage direct ou direct-indirect. Canal lumineux en profilé d'aluminium extrudé d'une largeur de 50 mm. Luminaire de forme carrée avec coins soudés - livraison des trois tailles standard complètes en une pièce (660, 1020 mm) ou en deux pièces (1500 mm). Surface du luminaire à structure entièrement en une seule pièce. Surface du luminaire à structure fine matte revêtue par poudre similaire à RAL 9016 blanc, RAL 9006 argent ou RAL 9005 noir - sur demande en RAL au choix. Diffuseur au choix en PMMA opale ou en PMMA transparent avec plaque microprismatique insérée pour un éblouissement réduit (UGR<19). Luminaire avec rosace rectangulaire blanche, câble d'alimentation transparent, de câbles flexibles et tendeurs rapides permettant de régler la hauteur de montage en continu. Le pilote LED est intégré dans le boîtier du luminaire - au choix sous forme de variante on/off ou DALI - températures de couleur 2700K, 3000K, 4000K ou blanc dynamique (2700K-6500K) - rendu des couleurs CRI>80 ou CRI>90 - Mac Adam ≤3. Autres options de commande ou couleurs de lumière disponibles sur demande. En outre, l'intégration de nombreux composants, tels que l'éclairage de secours ou la technologie des capteurs, une multitude d'autres options sont possibles.

## ÜBERSICHT | OVERVIEW | VUE D'ENSEMBLE

### TECHNICAL DATA

2700K / 3000K / 4000K / 2700-6500K

CRI>80 / CRI>90

MacAdam ≤ 3

up to 141 lm/W, up to 6.268 lm/m

on-off / DALI

direct / direct + indirect

opal / microprism (UGR <19)

L80 B10 50.000h

### HOUSING COLOUR

schwarz | black | noir  
RAL 9005

silber | silver | argent  
RAL 9006

weiß | white | blanc  
RAL 9016



RAL colour of your choice



Integration of 3-phase-track



Integration of Multisensor



Welded mitre cuts



Integration of emergency light



Integration of GLOWmini/  
GLOWsmall series



Design Cables



Contact us for more options...

**HÄNGELEUCHTE „LINE50quad“**  
 PENDANT LUMINAIRE “LINE50quad”  
 LUMINAIRE SUSPENSION « LINE50quad »

Bestellbeispiel | Example order | Exemple de commande  
 660 x 660 mm, CRI>90, 4000K, direct + indirect, low output on/off, black, microprism

**LQ50H-069402-LOBLM**

1 2 3 4 5 6 7

**1 GRÖSSE**  
 SIZE  
 TAILLE

660 x 660 mm	<b>06</b>
1.020 x 1.020 mm	<b>10</b>
1.500 x 1.500 mm	<b>15</b>

**2 FARBWIEDERGABE**  
 COLOUR RENDERING  
 RENDU DES COULEURS

CRI>80	<b>8</b>
CRI>90	<b>9</b>

**3 FARBTEMPERATUR**  
 COLOUR TEMPERATURE  
 TEMPÉRATURE DE COULEUR

2700K (CRI>90 only)	<b>27</b>
3000K	<b>30</b>
4000K	<b>40</b>
2700-6500K (CRI>90 only)	<b>DW</b>

**4 LICHTVERTEILUNG**  
 LIGHT DISTRIBUTION  
 DISTRIBUTION DE LA LUMIÈRE

direct	<b>1</b>
direct + indirect	<b>2</b>

**5 LEISTUNG & STEUERUNG**  
 OUTPUT & CONTROL  
 SORTIE & CONTRÔLE

low output on/off	<b>LO</b>
low output DALI	<b>LD</b>
high output on/off	<b>HO</b>
high output DALI	<b>HD</b>
dynamic white DALI DT8	<b>DW</b>

**6 GEHÄUSEFARBE**  
 HOUSING COLOUR  
 COULEUR DU BOÎTIER

silver RAL 9006	<b>SI</b>
white RAL 9016	<b>WH</b>
black RAL 9005	<b>BL</b>

**7 DIFFUSOR**  
 DIFFUSER  
 DIFFUSEUR

opal	<b>O</b>
microprism	<b>M</b>

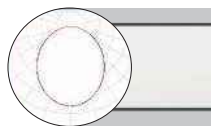
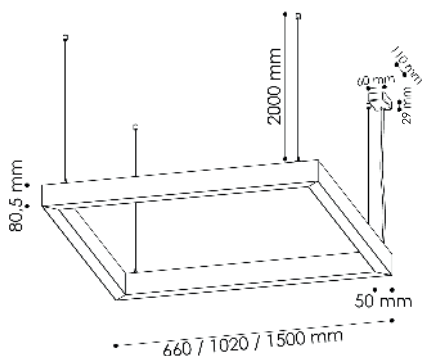

opal direct

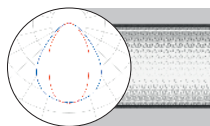

microprism direct

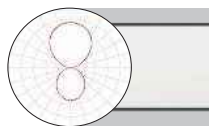

opal direct + indirect

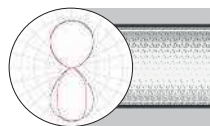

microprism direct + indirect

direct

direct + indirect

Size [mm]	opal direct		microprism direct		opal direct + indirect		microprism direct + indirect		direct [kg]	direct + indirect [kg]
	low output [lm] / [W]	high output [lm] / [W]	low output [lm] / [W]	high output [lm] / [W]	low output [lm] / [W]	high output [lm] / [W]	low output [lm] / [W]	high output [lm] / [W]		
□ 660	3.637 / 29,1	6.926 / 57,2	3.304 / 29,1	6.324 / 57,2	8.240 / 54,3	15.796 / 111,4	7.692 / 54,3	14.672 / 111,4	6,0	7,2
□ 1.020	5.821 / 44,6	11.080 / 91,7	5.284 / 44,6	10.120 / 91,7	13.184 / 85,8	25.276 / 180,0	12.308 / 85,8	23.476 / 180,0	9,2	12,0
□ 1.500	8.728 / 67,0	16.624 / 134,8	7.928 / 67,0	15.176 / 134,8	19.778 / 130,6	37.909 / 266,2	18.460 / 130,6	35.212 / 266,2	14,0	17,6

Alle Lumenangaben für 4000K, CRI>80, Microprisma ohne Opalfolie

All lumen values for 4000K, CRI>80, microprism without opal foil

Toutes les données de lumens pour 4000K, CRI>80, microprisme sans feuille opale

# LINE50QUADmute

HÄNGELEUCHE | PENDANT LUMINAIRE | LUMINAIRE SUSPENSION

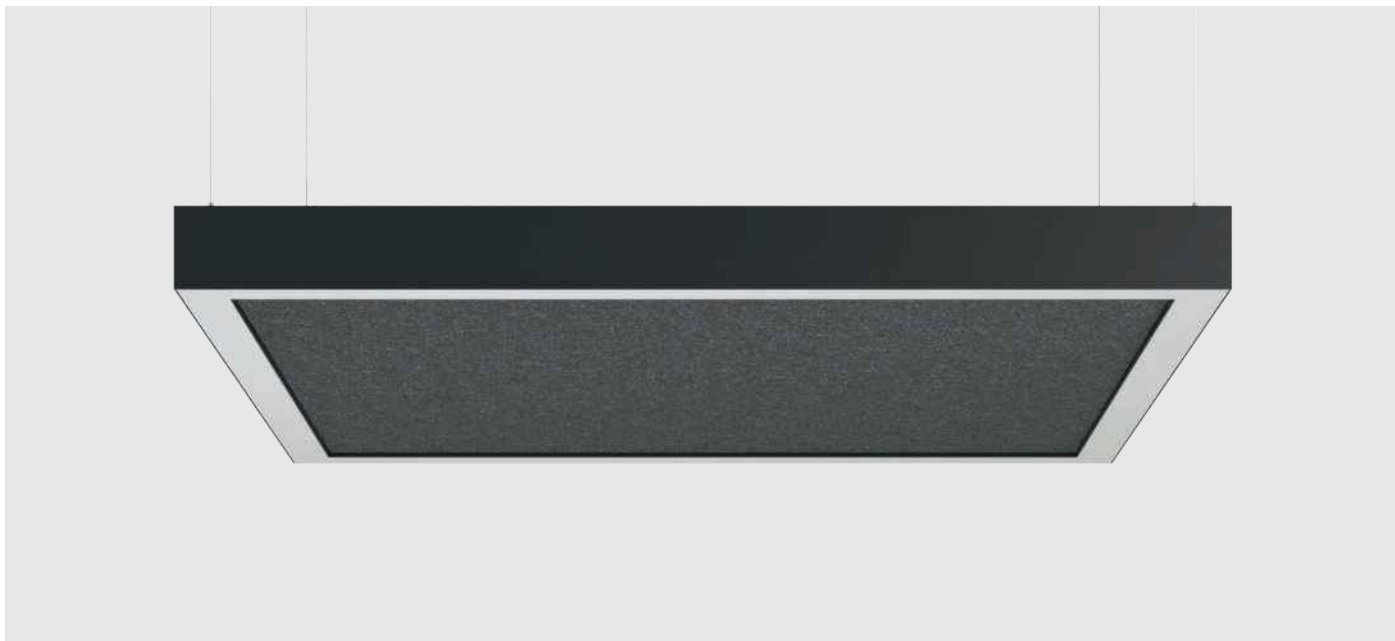

**LED-Hängeleuchte** direktstrahlend oder direkt-indirektstrahlend. Lichtkanal aus Aluminium-Strangpressprofil mit einer Breite von 50 mm. Leuchte in quadratischer Form mit verschweißten Ecken – Lieferung der zwei Standardgrößen komplett in einem Stück (660, 1020 mm). Oberfläche der Leuchte feinstruktur matt pulverbeschichtet ähnlich RAL 9016 weiß, RAL 9006 silber oder RAL 9005 schwarz – auf Anfrage in RAL nach Wahl. Akustikelemente aus recyceltem PET in schwarz, hellgrau meliert, anthrazit meliert, burgunderrot oder olivgrün auswählbar. Diffusor wahlweise in PMMA opal oder PMMA klar mit eingeschobener mikroprismatischer Platte für eine reduzierte Leuchtdichte (UGR<19). Leuchte inkl. weißem, rechteckigem Baldachin mit transparentem Einspeisekabel sowie flexiblen Seilabhängern und Schnellspannern zur stufenlosen Regulierung der Montagehöhe. Der LED-Treiber ist im Leuchtgehäuse integriert – wahlweise als on/off oder DALI-Variante – Farbtemperaturen 2700K, 3000K, 4000K oder dynamisch Weiß (2700K– 6500K) – Farbwiedergabe CRI>80 oder CRI>90 – Mac Adam ≤3.

**Pendant LED luminaire** direct beam or direct-indirect beam. Light channel made of extruded aluminium profile with a width of 50 mm. Luminaire in square shape with welded corners - delivery of the two standard sizes in one piece (660, 1020 mm). Surface of the luminaire fine structure matt powder coated similar to RAL 9016 white, RAL 9006 silver or RAL 9005 black - on request in RAL of choice. Acoustic elements made of recycled PET available in black, light grey mottled, anthracite mottled, burgundy red or olive green. Diffuser either in PMMA opal or PMMA clear with inserted microprismatic plate for reduced luminance (UGR<19). Luminaire incl. white, rectangular canopy with transparent feeding cable as well as flexible wire suspensions and quick-release fasteners for stepless adjustment of mounting height. The LED driver is integrated in the luminaire housing - either as on/off or DALI version - colour temperatures 2700K, 3000K, 4000K or dynamic white (2700K-6500K) - colour rendering CRI>80 or CRI>90 - Mac Adam ≤3.

**Suspension LED** à éclairage direct ou direct-indirect. Canal lumineux en profilé d'aluminium extrudé d'une largeur de 50 mm. Luminaire de forme carrée avec coins soudés - livraison des deux tailles standard complètes en une pièce (660, 1020 mm). Surface du luminaire à structure entièrement en une seule pièce. Surface du luminaire à structure fine matte revêtue par poudre similaire à RAL 9016 blanc, RAL 9006 argent ou RAL 9005 noir - sur demande en RAL au choix. Éléments acoustiques fabriqués en PET recycle en noir, gris clair chiné, anthracite chiné, rouge bordeaux ou vert olive au choix. Diffuseur au choix en PMMA opale ou en PMMA transparent avec plaque microprismatique insérée pour un éblouissement réduit (UGR<19). Luminaire avec rosace rectangulaire blanche, câble d'alimentation transparent, de câble flexibles et tendeurs rapides permettant de régler la hauteur de montage en continu. Le pilote LED est intégré dans le boîtier du luminaire - au choix sous forme de variante on/off ou DALI - températures de couleur 2700K, 3000K, 4000K ou blanc dynamique (2700K-6500K) - rendu des couleurs CRI>80 ou CRI>90 - Mac Adam ≤3.

## ÜBERSICHT | OVERVIEW | VUE D'ENSEMBLE

TECHNICAL DATA
2700K / 3000K / 4000K / 2700-6500K
CRI>80 / CRI>90
MacAdam ≤ 3
up to 154 lm/W, up to 6268 lm/m
on-off / DALI
direct / direct + indirect
opal / microprism (UGR <19)
L80 B10 50.000h
acoustic material - fire classification: B-s2, d0 (EN13501-1:3018)

<p>RAL colour of your choice</p> <p>Contact us for more options...</p>							

HOUSING COLOUR	
schwarz   black   noir RAL 9005	
silber   silver   argent RAL 9006	
weiß   white   blanc RAL 9016	

COLOUR ACOUSTIC PANEL			
schwarz   black   noir		burgunderrot   burgundy red   rouge bourgogne	
hellgrau meliert   light grey mottled   gris clair chiné		olivgrün   olive green   vert olive	
anthrazit meliert   anthracite mottled   anthracite chiné			

**HÄNGELEUCHTE „LINE50QUADmute“**  
 PENDANT LUMINAIRE “LINE50QUADmute”  
 LUMINAIRE SUSPENSION « LINE50QUADmute »

Bestellbeispiel | Example order | Exemple de commande  
 660 x 660 mm, CRI90, 4000K, direct + indirect, low output on/off, black, olive, microprism

**LQ5MH-069402-LOBOM**

1 2 3 4 5 6 7 8

**1 GRÖSSE**  
 SIZE  
 TAILLE

660 x 660 mm	<b>06</b>
1.020 x 1.020 mm	<b>10</b>

**2 FARBWIEDERGABE**  
 COLOUR RENDERING  
 RENDU DES COULEURS

CRI>80	<b>8</b>
CRI>90	<b>9</b>

**3 FARBTEMPERATUR**  
 COLOUR TEMPERATURE  
 TEMPÉRATURE DE COULEUR

2700K (CRI>90 only)	<b>27</b>
3000K	<b>30</b>
4000K	<b>40</b>
2700-6500K (CRI>90 only)	<b>DW</b>

**4 LICHTVERTEILUNG**  
 LIGHT DISTRIBUTION  
 DISTRIBUTION DE LA LUMIÈRE

direct	<b>1</b>
direct + indirect	<b>2</b>

**5 LEISTUNG & STEUERUNG**  
 OUTPUT & CONTROL  
 SORTIE & CONTRÔLE

low output on/off	<b>LO</b>
low output DALI	<b>LD</b>
high output on/off	<b>HO</b>
high output DALI	<b>HD</b>
dynamic white DALI DT8	<b>DW</b>

**6 GEHÄUSEFARBE**  
 HOUSING COLOUR  
 COULEUR DU BOÎTIER

silver RAL 9006	<b>S</b>
white RAL 9016	<b>W</b>
black RAL 9005	<b>B</b>

**7 FARBE AKUSTIKPLATTE**  
 COLOUR ACOUSTIC PANEL  
 COULEUR PANNEAU ACOUSTIQUE

black	<b>B</b>
light grey mottled	<b>S</b>
anthracite mottled	<b>A</b>
burgundy red	<b>R</b>
olive green	<b>O</b>

**8 DIFFUSOR**  
 DIFFUSER  
 DIFFUSEUR

opal	<b>O</b>
microprism	<b>M</b>

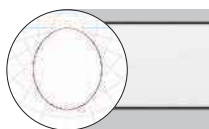
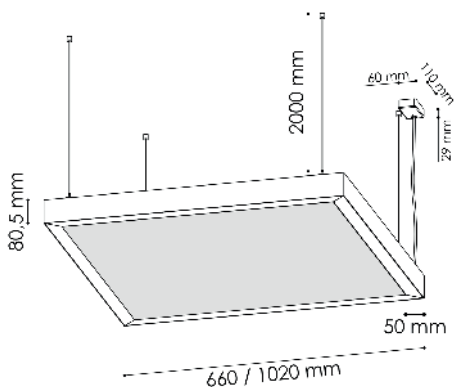

opal direct

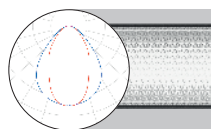

microprism direct

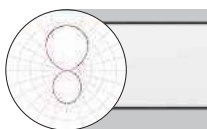

opal direct + indirect

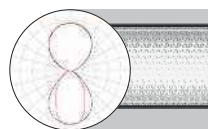

microprism direct + indirect

direct

direct + indirect

Size [mm]	low output [lm] / [W]	high output [lm] / [W]	low output [lm] / [W]	high output [lm] / [W]	low output [lm] / [W]	high output [lm] / [W]	low output [lm] / [W]	high output [lm] / [W]	[kg]	[kg]
□ 660	3.637 / 29,1	6.926 / 57,2	3.304 / 29,1	6.324 / 57,2	8.240 / 54,3	15.796 / 111,4	7.692 / 54,3	14.672 / 111,4	7,3	8,5
□ 1.020	5.821 / 44,6	11.080 / 91,7	5.284 / 44,6	10.120 / 91,7	13.184 / 85,8	25.276 / 180,0	12.308 / 85,8	23.476 / 180,0	12,7	15,5

Alle Lumenangaben für 4000K, CRI>80, Microprisma ohne Opalfolie  
 All lumen values for 4000K, CRI>80, microprism without opal foil  
 toutes les données de lumens pour 4000K, CRI>80, microprisme sans feuille opale

# LINE50splash

HÄNGELEUCHE | PENDANT LUMINAIRE | LUMINAIRE SUSPENSION



**LED-Hängeleuchte** mit erhöhter Schutzart IP54 direktstrahlend. Lichtkanal aus Aluminium-Strangpressprofil mit einer Breite von 50 mm. Oberfläche der Leuchte feinstruktur matt pulverbeschichtet ähnlich RAL 9016 weiß, RAL 9006 silber oder RAL 9005 schwarz – auf Anfrage in RAL nach Wahl. Diffusor wahlweise in PMMA opal, PMMA klar mit eingeschobener asymmetrischer Folie oder PMMA klar mit eingeschobener mikroprismatischer Platte für eine reduzierte Leuchtdichte (UGR<19). Leuchte inkl. transparentem Einspeisekabel sowie flexiblen Seilabhängern und Schnellspannern zur stufenlosen Regulierung der Montagehöhe. Der LED-Treiber ist im Leuchtgehäuse integriert – wahlweise als on/off oder DALI-Variante – Farbtemperaturen 2700K, 3000K, 4000K oder dynamisch Weiß (2700K–6500K) – Farbwiedergabe CRI>80 oder CRI>90 – Mac Adam ≤3. Weitere Steuerungsoptionen oder Lichtfarben auf Anfrage erhältlich. Außerdem ist die Integration vieler Komponenten, wie beispielsweise Notlicht, sowie eine Vielzahl weiterer Optionen möglich.

**Pendant LED luminaire** with increased protection rating IP54 and direct beam. Light channel made of extruded aluminium profile with a width of 50 mm. Surface of the luminaire fine structure matt powder coated similar to RAL 9016 white, RAL 9006 silver or RAL 9005 black - on request in RAL of choice. Diffuser either in PMMA opal, PMMA clear with inserted asymmetric foil or PMMA clear with inserted microprismatic plate for reduced luminance (UGR<19). Luminaire incl. transparent feeding cable as well as flexible cord suspensions and quickrelease clamps for continuous adjustment of mounting height. The LED driver is integrated in the luminaire housing - either as on/off or DALI version - colour temperatures 2700K, 3000K, 4000K or dynamic white (2700K-6500K) - colour rendering CRI>80 or CRI>90 - Mac Adam ≤3. Further control options or light colours available on request. In addition, the integration of many components, such as emergency lighting, as well as a variety of other options is possible.

**Suspension LED** avec un degré de protection élevé IP54 à éclairage direct. Canal lumineux en profilé d'aluminium extrudé d'une largeur de 50 mm. Surface du luminaire à structure fine, revêtement par poudre mat similaire à RAL 9016 blanc, RAL 9006 argent ou RAL 9005 noir - sur demande en RAL au choix. Diffuseur au choix en PMMA opale, PMMA transparent avec feuille asymétrique insérée ou PMMA transparent avec plaque microprismatique insérée pour un éblouissement réduit (UGR<19). Luminaire comprenant câble d'alimentation transparent ainsi que des câbles flexibles et des tendeurs rapides permettant de régler la hauteur de montage en continu. Le pilote LED est intégré dans le boîtier du luminaire - au choix sous forme de variante on/off ou DALI - températures de couleur 2700K, 3000K, 4000K ou blanc dynamique (2700K-6500K) - rendu des couleurs CRI>80 ou CRI>90 - Mac Adam ≤3. Autres options de commande ou couleurs de lumière disponibles sur demande. En outre, l'intégration de nombreux composants, tels que l'éclairage de secours, une multitude d'autres options sont possibles.

## ÜBERSICHT | OVERVIEW | VUE D'ENSEMBLE

### TECHNICAL DATA

2700K / 3000K / 4000K / 2700-6500K

CRI>80 / CRI>90

MacAdam ≤ 3

up to 130 lm/W, up to 2.930 lm/m

on-off / DALI

direct

opal / microprism (UGR <19) / asymmetric

L80 B10 50.000h

### HOUSING COLOUR

schwarz | black | noir  
RAL 9005

silber | silver | argent  
RAL 9006

weiß | white | blanc  
RAL 9016



RAL colour of your choice



Integration of emergency light



Contact us for more options...

**HÄNGELEUCHTE „LINE50splash“**  
 PENDANT LUMINAIRE “LINE50splash”  
 LUMINAIRE SUSPENSION « LINE50splash »

Bestellbeispiel | Example order | Exemple de commande  
 3.145 mm, CRI90, 4000K, **direct**, low output on/off, black, microprism

**LS50H-319401-LOBLM**

1 2 3 4 5 6

1 LÄNGE LENGTH LONGEUR	
1.225 mm	12
1.465 mm	14
1.705 mm	17
1.945 mm	19
2.185 mm	21
2.425 mm	24
2.905 mm	29
3.145 mm	31
3.867 mm	38

2 FARBWIEDERGABE COLOUR RENDERING RENDU DES COULEURS	
CRI>80	8
CRI>90	9

3 FARBTEMPERATUR COLOUR TEMPERATURE TEMPÉRATURE DE COULEUR	
2700K (CRI>90 only)	27
3000K	30
4000K	40
2700-6500K (CRI>90 only)	DW

4 LEISTUNG & STEUERUNG OUTPUT & CONTROL SORTIE & CONTRÔLE	
low output on/off	LO
low output DALI	LD
high output on/off	HO
high output DALI	HD
dynamic white DALI DT8	DW

5 GEHÄUSEFARBE HOUSING COLOUR COULEUR DU BOÎTIER	
silver RAL 9006	SI
white RAL 9016	WH
black RAL 9005	BL

6 DIFFUSOR DIFFUSER DIFFUSEUR	
opal	O
microprism	M
asymmetric	A

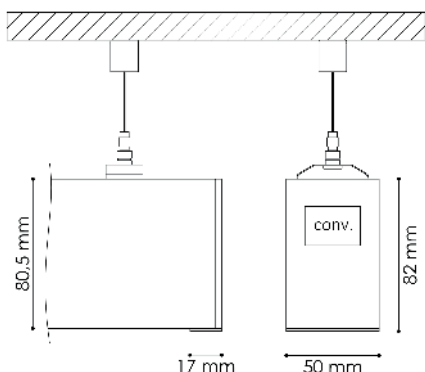

opal direct

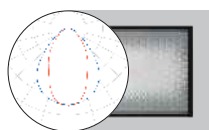

microprism direct



asymmetric direct

Size [mm]	low output [lm] / [W]		high output [lm] / [W]		low output [lm] / [W]		high output [lm] / [W]		KG
	low output [lm]	high output [W]	low output [lm]	high output [W]	low output [lm]	high output [W]	low output [lm]	high output [W]	
1.225	1.818	16,3	3.463	30,0	1.652	16,3	3.162	30,0	3,3
1.465	2.182	18,5	4.156	35,8	1.982	18,5	3.794	35,8	3,9
1.705	2.546	21,2	4.848	41,1	2.313	21,2	4.427	41,1	4,5
1.945	2.911	23,7	5.541	46,3	2.642	23,7	5.059	46,3	5,0
2.185	3.273	26,6	6.233	52,0	2.974	26,6	5.692	52,0	5,6
2.425	3.635	29,2	6.926	57,3	3.304	29,2	6.324	57,3	6,2
2.905	4.364	34,3	8.311	69,6	3.964	34,3	7.589	69,6	7,4
3.145	4.728	36,9	9.004	75,5	4.295	36,9	8.221	75,5	7,9
3.867	5.821	47,4	11.082	92,6	5.284	47,4	10.118	92,6	9,7

Alle Lumenangaben für 4000K, CRI>80, Microprisma ohne Opalfolie  
 All lumen values for 4000K, CRI>80, microprism without opal foil  
 Toutes les données de lumens pour 4000K, CRI>80, microprisme sans feuille opale



# officeLINE50

HÄNGELEUCHE | PENDANT LUMINAIRE | LUMINAIRE SUSPENSION

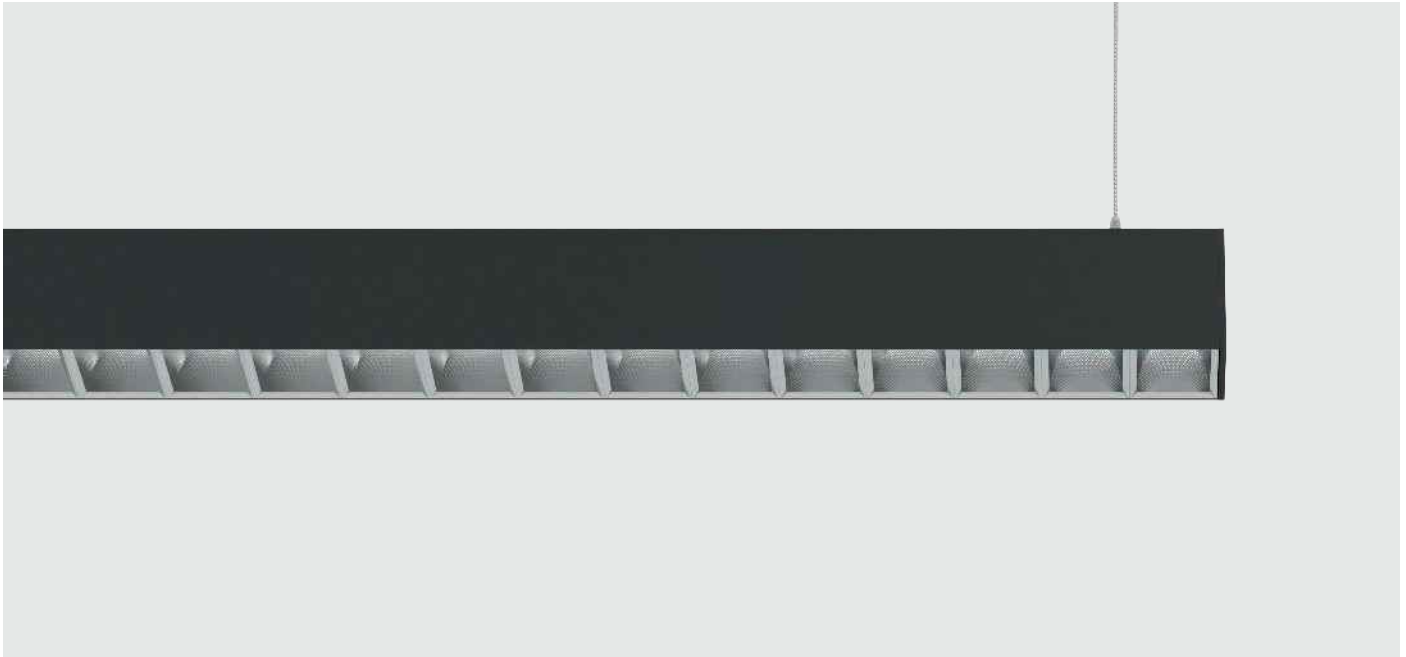

**LED-Hängeleuchte** direktstrahlend oder direkt-indirektstrahlend. Lichtkanal aus Aluminium-Strangpressprofil mit einer Breite von 50 mm. Fertigung der Leuchtenlänge millimetergenau auf Kundenwunsch möglich. Oberfläche der Leuchte feinstrukturiert matt pulverbeschichtet ähnlich RAL 9016 weiß, RAL 9006 silber oder RAL 9005 schwarz – auf Anfrage in RAL nach Wahl. Die Leuchte ist ausgestattet mit einem hochwertigen, facettierten BAP-Raster mit einer Auswahl an sieben verschiedenen Farben – Oberfläche hochglänzend bzw. matt. Leuchte inkl. weißem, rechteckigem Baldachin mit transparentem Einspeisekabel sowie flexiblen Seilabhängern und Schnellspannern zur stufenlosen Regulierung der Montagehöhe. Der LED-Treiber ist im Leuchtgehäuse integriert – wahlweise als on/off oder DALI-Variante. Farbtemperaturen 2700K, 3000K, 4000K oder dynamisch Weiß (2700K–6500K) – Farbwiedergabe CRI>80 oder CRI>90 – Mac Adam ≤3.

**Pendant LED luminaire** with direct beam or direct-indirect beam. Light channel made of extruded aluminium profile with a width of 50 mm. Luminaire length can be manufactured to the exact millimetre on customer request. Surface of the luminaire fine structure matt powder coated similar to RAL 9016 white, RAL 9006 silver or RAL 9005 black - on request in RAL of choice. The luminaire is equipped with a high-quality, faceted BAP louvre with a choice of seven different colours - surface specular or matt. Luminaire incl. white, rectangular canopy with transparent feeding cable as well as flexible wire suspension and quick-release clamps for continuous adjustment of mounting height. The LED driver is integrated in the luminaire housing - either as on/off or DALI version. Colour temperatures 2700K, 3000K, 4000K or dynamic white (2700K-6500K) - colour rendering CRI>80 or CRI>90 - Mac Adam ≤3.

**Suspension LED** à éclairage direct ou direct-indirect. Canal lumineux en profilé d'aluminium extrudé d'une largeur de 50 mm. Fabrication de la longueur du luminaire au millimètre près possible sur demande du client. Surface du luminaire à structure fine, revêtement par poudre mat similaire à RAL 9016 blanc, RAL 9006 argent ou RAL 9005 noir - sur demande en RAL au choix. Le luminaire est équipé d'une grille BAP à facettes de haute qualité avec un choix de sept couleurs différentes - surface brillante ou mate. Le luminaire rectangulaire blanc avec un câble d'alimentation transparent ainsi que des câbles flexibles et des fixations rapides permettant de régler la hauteur de montage en continu. Le pilote LED est intégré dans le boîtier du luminaire - au choix sous forme de variante on/off ou DALI. Températures de couleur 2700K, 3000K, 4000K ou blanc dynamique (2700K-6500K) - Rendu des couleurs CRI>80 ou CRI>90 - Mac Adam ≤3.

## ÜBERSICHT | OVERVIEW | VUE D'ENSEMBLE

### TECHNICAL DATA

2700K / 3000K / 4000K / 2700-6500K

CRI>80 / CRI>90

MacAdam ≤ 3

up to 162 lm/W, up to 7.425 lm/m

on-off / DALI

direct / direct + indirect

BAP-Louvre (UGR <19)

L80 B10 50.000h



RAL colour of your choice



Integration of 3-phase-track



Integration of Multisensor



Welded mitre cuts



Integration of emergency light



Integration of GLOWmini/  
GLOWsmall series



Design Cables



Contact us for more options...

### HOUSING COLOUR

schwarz | black | noir  
RAL 9005



silber | silver | argent  
RAL 9006



weiß | white | blanc  
RAL 9016



### DECORATION RING COLOUR

silber hochglanz | silver specular | argenté brillant



gold hochglanz | gold specular | doré brillant



silber matt | silver matt | argenté mat



bronze hochglanz | bronze specular | bronze brillant



schwarz hochglanz | black specular | noir brillant



titan hochglanz | titan specular | titan brillant



schwarz matt | black matt | noir mat



**HÄNGELEUCHTE „officeLINE50“**  
 PENDANT LUMINAIRE “officeLINE50”  
 LUMINAIRE SUSPENSION « officeLINE50 »

Bestellbeispiel | Example order | Exemple de commande  
 3.372 mm, CRI>90, 4000K, direct + indirect, low output on/off, black, gold specular

**OL50H-339402-LOBLG**

1 2 3 4 5 6 7

1 LÄNGE LENGTH LONGEUR	
1.211 mm	12
1.451 mm	14
1.691 mm	16
2.171 mm	21
2.891 mm	28
3.372 mm	33

2 FARBWIEDERGABE COLOUR RENDERING RENDU DES COULEURS	
CRI>80	8
CRI>90	9

3 FARBTemperatur COLOUR TEMPERATURE TEMPÉRATURE DE COULEUR	
2700K (CRI>90 only)	27
3000K	30
4000K	40
2700-6500K (CRI>90 only)	DW

4 LICHTVERTEILUNG LIGHT DISTRIBUTION DISTRIBUTION DE LA LUMIÈRE	
direct	1
direct + indirect	2

5 LEISTUNG & STEUERUNG OUTPUT & CONTROL SORTIE & CONTRÔLE	
low output on/off	LO
low output DALI	LD
high output on/off	HO
high output DALI	HD
dynamic white DALI DT8	DW

6 GEHÄUSEFARBE HOUSING COLOUR COULEUR DU BOÎTIER	
silver RAL 9006	SI
white RAL 9016	WH
black RAL 9005	BL

7 BAP-RASTER FARBE BAP LOUVRE COLOUR GRILLE BAP COULEUR	
silver specular	S
silver matt	M
black specular	N
black matt	B
gold specular	G
bronze specular	C
titan specular	T

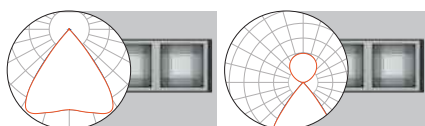
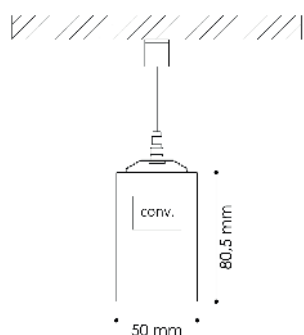

Size [mm]	direct		direct + indirect		direct	direct + indirect
	low output [lm] / [W]	high output [lm] / [W]	low output [lm] / [W]	high output [lm] / [W]	KG	KG
1.211	2.765 / 20,0	5.160 / 39,0	4.673 / 30,9	8.863 / 63,9	3,2	3,3
1.451	3.318 / 23,5	6.192 / 46,0	5.608 / 36,6	10.636 / 77,1	3,8	3,9
1.671	3.871 / 27,0	7.224 / 53,2	6.542 / 43,8	12.408 / 89,9	4,3	4,5
2.171	4.977 / 33,9	9.288 / 67,0	8.411 / 56,0	15.953 / 113,8	5,1	5,3
2.891	6.636 / 43,8	12.384 / 87,9	11.215 / 69,4	21.271 / 150,8	6,5	6,8
3.372	7.742 / 54,0	14.448 / 106,4	13.084 / 87,6	24.816 / 179,8	8,0	8,2

Alle Lumenangaben für 4000K, CRI>80, Reflektor silber hochglanz  
 All lumen values for 4000K, CRI>80, reflector silver specular  
 Toutes les données de lumens pour 4000K, CRI>80, réflecteur argenté brillant

# officeLINE50

HÄNGELEUCHTE MIT SENSOR | PENDANT LUMINAIRE WITH SENSOR | LUMINAIRE SUSPENDOU AVEC CAPTEUR



**LED-Hängeleuchte** direktstrahlend oder direkt-indirektstrahlend. Lichtkanal aus Aluminium-Strangpressprofil mit einer Breite von 50 mm. Fertigung der Leuchtenlänge millimetergenau auf Kundenwunsch möglich. Oberfläche der Leuchte feinstruktur matt pulverbeschichtet ähnlich RAL 9016 weiß, RAL 9006 silber oder RAL 9005 schwarz – auf Anfrage in RAL nach Wahl. Die Leuchte ist ausgestattet mit einem hochwertigen, facettierten BAP-Raster mit einer Auswahl an sieben verschiedenen Farben – Oberfläche hochglänzend bzw. matt. Leuchte inkl. weißem, rechteckigem Baldachin mit transparentem Einspeisekabel sowie flexiblen Seilabhängern und Schnellspannern zur stufenlosen Regulierung der Montagehöhe. Der LED-Treiber ist im Leuchtgehäuse integriert. Farbtemperaturen 2700K, 3000K, 4000K oder dynamisch Weiß (2700K-6500K) – Farbwiedergabe CRI>80 oder CRI>90 – Mac Adam ≤3. Leuchte inkl. Bewegungs- und Tageslichtsensor – zusätzliche Farbregelung bei der dynamisch Weiß Variante – Sensor eingebaut in 240 mm langer Blindabdeckung. Weitere Steuerungsoptionen oder Lichtfarben auf Anfrage erhältlich. Außerdem ist die Integration vieler Komponenten, wie beispielsweise Notlicht, sowie eine Vielzahl weiterer Optionen möglich.

**Pendant LED luminaire** with direct beam or direct-indirect beam. Light channel made of extruded aluminium profile with a width of 50 mm. Luminaire length can be manufactured to the exact millimetre on customer request. Surface of the luminaire fine structure matt powder coated similar to RAL 9016 white, RAL 9006 silver or RAL 9005 black - on request in RAL of choice. The luminaire is equipped with a high-quality, faceted BAP louvre with a choice of seven different colours - surface specular or matt. Luminaire incl. white, rectangular canopy with transparent feeding cable as well as flexible wire suspension and quick-release clamps for continuous adjustment of mounting height. The LED driver is integrated in the luminaire housing - either as on/off or DALI version. Colour temperatures 2700K, 3000K, 4000K or dynamic white (2700K-6500K) - colour rendering CRI>80 or CRI>90 - Mac Adam ≤3. Luminaire incl. motion and daylight sensor - additional colour control for dynamic white version - sensor built into 240 mm long blind cover. Further control options or light colours available on request. In addition, the integration of many components, such as emergency lighting or sensor technology, as well as a variety of other options is possible.

**Suspension LED** à éclairage direct ou direct-indirect. Canal lumineux en profilé d'aluminium extrudé d'une largeur de 50 mm. Fabrication de la longueur du luminaire au millimètre près possible sur demande du client. Surface du luminaire à structure fine, revêtement par poudre mat similaire à RAL 9016 blanc, RAL 9006 argent ou RAL 9005 noir - sur demande en RAL au choix. Le luminaire est équipé d'une grille BAP à facettes de haute qualité avec un choix de sept couleurs différentes - surface brillante ou mate. Le luminaire rectangulaire blanc avec un câble d'alimentation transparent ainsi que des câbles flexibles et des fixations rapides permettant de régler la hauteur de montage en continu. Le pilote LED est intégré dans le boîtier du luminaire - au choix sous forme de variante on/off ou DALI. Températures de couleur 2700K, 3000K, 4000K ou blanc dynamique (2700K-6500K) - Rendu des couleurs CRI>80 ou CRI>90 - Mac Adam ≤3. Luminaire avec capteur de mouvement et de lumière du jour - réglage supplémentaire de la couleur pour la version blanc dynamique - capteur intégré dans un cache de 240 mm de long. Autres options de commande ou couleurs de lumière disponibles sur demande. En outre, l'intégration de nombreux composants, tels que l'éclairage de secours ou la technologie de détection, une multitude d'autres options sont possibles.

## ÜBERSICHT | OVERVIEW | VUE D'ENSEMBLE

### TECHNICAL DATA

2700K / 3000K / 4000K / 2700-6500K

CRI>80 / CRI>90

MacAdam ≤ 3

up to 162 lm/W, up to 7.425 lm/m

DALI Sensor

direct / direct + indirect

BAP-Louvre (UGR <19)

L80 B10 50.000h



RAL colour of your choice



Welded mitre cuts



Integration of emergency light

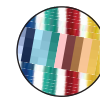

Design Cables



Contact us for more options...

### HOUSING COLOUR

schwarz | black | *noir*  
RAL 9005



silber | silver | *argent*  
RAL 9006



weiß | white | *blanc*  
RAL 9016



### DECORATION RING COLOUR

silber hochglanz | silver specular | *argenté brillant*



gold hochglanz | gold specular | *doré brillant*



silber matt | silver matt | *argenté mat*



bronze hochglanz | bronze specular | *bronze brillant*



schwarz hochglanz | black specular | *noir brillant*



titan hochglanz | titan specular | *titan brillant*



schwarz matt | black matt | *noir mat*



**HÄNGELEUCHTE MIT SENSOR „officeLINE50“**  
**PENDANT LUMINAIRE WITH SENSOR "officeLINE50"**  
**LUMINAIRE SUSPENDOU AVEC CAPTEUR « officeLINE50 »**

Bestellbeispiel | Example order | Exemple de commande  
 1.451 mm, CRI>90, 4000K, direct + indirect, low output sensor, black, gold specular

**OL50H-149402-LSBLG**

1 2 3 4 5 6 7

**1 LÄNGE**  
**LENGTH**  
**LONGUEUR**

1.451 mm	<b>14</b>
1.691 mm	<b>16</b>
1.931 mm	<b>19</b>

**2 FARBWIEDERGABE**  
**COLOUR RENDERING**  
**RENDU DES COULEURS**

CRI>80	<b>8</b>
CRI>90	<b>9</b>

**3 FARBTEMPERATUR**  
**COLOUR TEMPERATURE**  
**TEMPÉRATURE DE COULEUR**

2700K (CRI>90 only)	<b>27</b>
3000K	<b>30</b>
4000K	<b>40</b>
2700-6500K (CRI>90 only)	<b>DW</b>

**4 LICHTVERTEILUNG**  
**LIGHT DISTRIBUTION**  
**DISTRIBUTION DE LA LUMIÈRE**

direct	<b>1</b>
direct + indirect	<b>2</b>

**5 LEISTUNG & STEUERUNG**  
**OUTPUT & CONTROL**  
**SORTIE & CONTRÔLE**

low output sensor	<b>LS</b>
high output sensor	<b>HS</b>
dynamic white sensor (DW only)	<b>DS</b>

**6 GEHÄUSEFARBE**  
**HOUSING COLOUR**  
**COULEUR DU BOÎTIER**

silver RAL 9006	<b>SI</b>
white RAL 9016	<b>WH</b>
black RAL 9005	<b>BL</b>

**7 BAP-RASTER FARBE**  
**BAP LOUVRE COLOUR**  
**GRILLE BAP COULEUR**

silver specular	<b>S</b>
silver matt	<b>M</b>
black specular	<b>N</b>
black matt	<b>B</b>
gold specular	<b>G</b>
bronze specular	<b>C</b>
titan specular	<b>T</b>

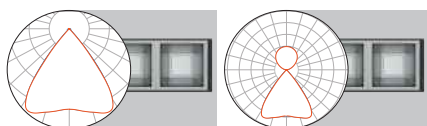
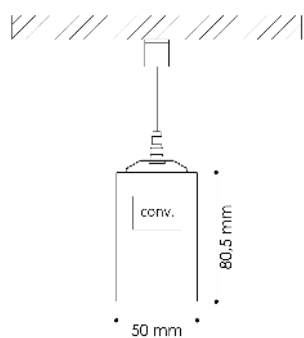

Size [mm]	direct		direct + indirect		direct [kg]	direct + indirect [kg]
	low output [lm] / [W]	high output [lm] / [W]	low output [lm] / [W]	high output [lm] / [W]		
1.451	2.765 / 20,5	5.160 / 39,4	4.673 / 32,6	8.863 / 66,9	3,8	3,9
1.691	3.318 / 24,0	6.192 / 46,5	5.608 / 38,3	10.636 / 79,8	4,3	4,5
1.931	3.871 / 27,6	7.224 / 53,8	6.542 / 45,5	12.408 / 92,2	4,9	5,0

Alle Lumenangaben für 4000K, CRI>80, Reflektor silber hochglanz  
 All lumen values for 4000K, CRI>80, reflector silver specular  
 Toutes les données de lumens pour 4000K, CRI>80, réflecteur argenté brillant

# LINE70

HÄNGELEUCHE | PENDANT LUMINAIRE | LUMINAIRE SUSPENSION

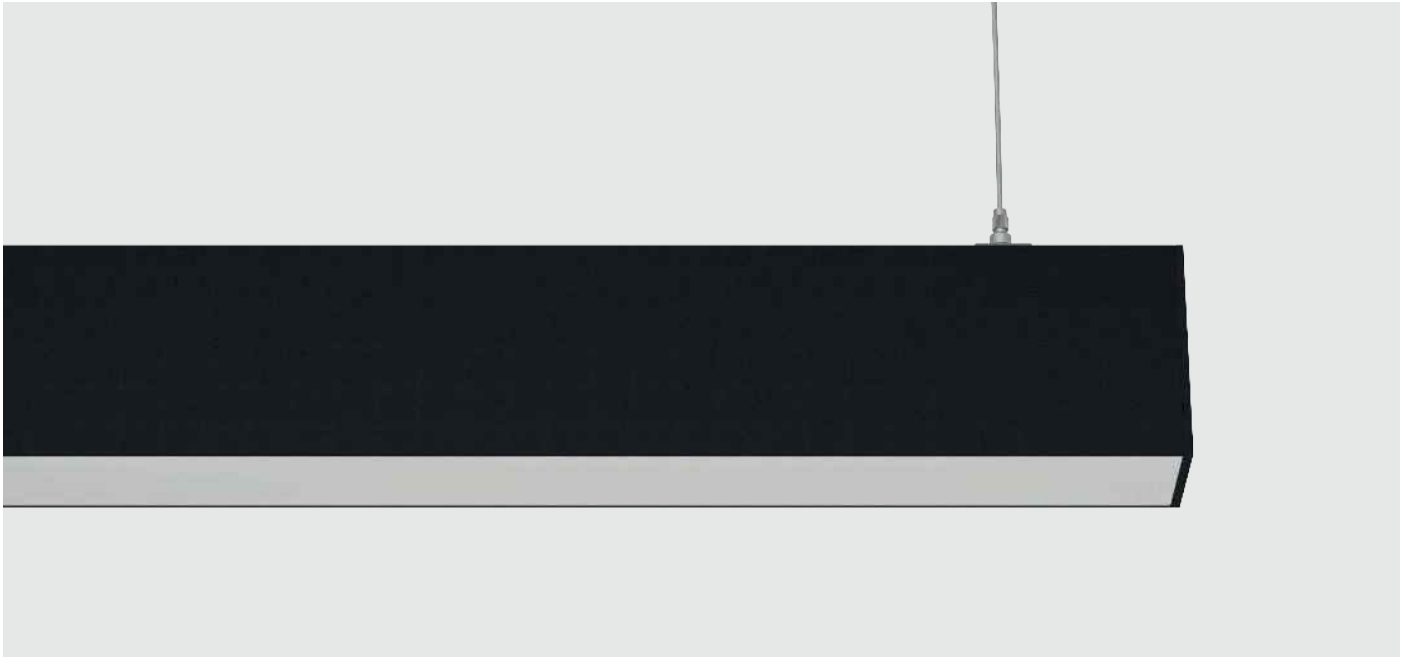

**LED-Hängeleuchte** direktstrahlend oder direkt-indirektstrahlend. Lichtkanal aus Aluminium-Strangpressprofil mit einer Breite von 71 mm. Fertigung der Leuchtenlänge millimetergenau auf Kundenwunsch möglich. Oberfläche der Leuchte feinstruktur matt pulverbeschichtet ähnlich RAL 9016 weiß, RAL 9006 silber oder RAL 9005 schwarz – auf Anfrage in RAL nach Wahl. Diffusor wahlweise in PMMA opal oder PMMA klar mit eingeschobener mikroprismatischer Platte für eine reduzierte Leuchtdichte (UGR<19). Leuchte inkl. weißem, rechteckigem Baldachin mit transparentem Einspeisekabel sowie flexiblen Seilabhängern und Schnellspannern zur stufenlosen Regulierung der Montagehöhe. Der LED-Treiber ist im Leuchtengehäuse integriert – wahlweise als on/off oder DALI-Variante. Farbtemperaturen 2700K, 3000K, 4000K oder dynamisch Weiß (2700K–6500K) – Farbwiedergabe CRI>80 oder CRI>90 – Mac Adam ≤3. Weitere Steuerungsoptionen oder Lichtfarben auf Anfrage erhältlich. Außerdem ist die Integration vieler Komponenten, wie beispielsweise Notlicht oder Sensortechnologie, sowie eine Vielzahl weiterer Optionen möglich.

**Pendant LED luminaire** direct beam or direct-indirect beam. Light channel made of extruded aluminium profile with a width of 71 mm. Luminaire length can be manufactured to the exact millimetre on customer request. Surface of the luminaire fine structure matt powder coated similar to RAL 9016 white, RAL 9006 silver or RAL 9005 black - on request in RAL of choice. Diffuser either in PMMA opal or PMMA clear with inserted microprismatic plate for reduced luminance (UGR<19). Luminaire incl. white, rectangular canopy with transparent feeding cable as well as flexible cord suspensions and quick-release clamps for continuous adjustment of mounting height. The LED driver is integrated in the luminaire housing - either as on/off or DALI version. Colour temperatures 2700K, 3000K, 4000K or dynamic white (2700K-6500K) - colour rendering CRI>80 or CRI>90 - Mac Adam ≤3. Further control options or light colours available on request. In addition, the integration of many components, such as emergency lighting or sensor technology, as well as a variety of other options is possible.

**Suspension LED** à éclairage direct ou direct-indirect. Canal lumineux en profilé d'aluminium extrudé d'une largeur de 71 mm. Fabrication de la longueur du luminaire au millimètre près possible sur demande du client. Surface du luminaire à structure fine, revêtement par poudre mat similaire à RAL 9016 blanc, RAL 9006 argent ou RAL 9005 noir - sur demande en RAL au choix. Diffuseur au choix en PMMA opale ou en PMMA transparent avec plaque microprismatique insérée pour un éblouissement réduit (UGR<19). Luminaire avec rosace rectangulaire blanche, câble d'alimentation transparent, de câble flexibles et tendeurs rapides permettant de régler la hauteur de montage en continu. Le pilote LED est intégré dans le boîtier du luminaire - au choix sous forme de variante on/off ou DALI. Températures de couleur 2700K, 3000K, 4000K ou blanc dynamique (2700K-6500K) - Rendu des couleurs CRI>80 ou CRI>90 - Mac Adam ≤3. Autres options de commande ou couleurs de lumière disponibles sur demande. En outre, l'intégration de nombreux composants, tels que l'éclairage de secours ou la technologie de détection, une multitude d'autres options sont possibles.

## ÜBERSICHT | OVERVIEW | VUE D'ENSEMBLE

### TECHNICAL DATA

2700K / 3000K / 4000K / 2700-6500K

CRI>80 / CRI>90

MacAdam ≤ 3

up to 161 lm/W, up to 6.958 lm/m

on-off / DALI

direct / direct + indirect

opal / microprism (UGR <19)

L80 B10 50.000h

### HOUSING COLOUR

schwarz | black | noir  
RAL 9005

silber | silver | argent  
RAL 9006

weiß | white | blanc  
RAL 9016



RAL colour of your choice



Integration of Multisensor



Welded mitre cuts



Integration of emergency light



Design Cables



Contact us for more options...

**HÄNGELEUCHTE „LINE70“**  
 PENDANT LUMINAIRE “LINE70”  
 LUMINAIRE SUSPENSION « LINE70 »

Bestellbeispiel | Example order | Exemple de commande  
 3.134 mm, CRI>90, 4000K, direct + indirect, low output on/off, black, microprism

**LI70H-319402-LOBLM**

1 2 3 4 5 6 7

1 LÄNGE LENGTH LONGEUR	
1.214 mm	12
1.454 mm	14
1.694 mm	16
1.934 mm	19
2.174 mm	21
2.414 mm	24
2.894 mm	28
3.134 mm	31
3.856 mm	38

2 FARBWIEDERGABE COLOUR RENDERING RENDU DES COULEURS	
CRI>80	8
CRI>90	9

3 FARBTEMPERATUR COLOUR TEMPERATURE TEMPÉRATURE DE COULEUR	
2700K (CRI>90 only)	27
3000K	30
4000K	40
2700-6500K (CRI>90 only)	DW

4 LICHTVERTEILUNG LIGHT DISTRIBUTION DISTRIBUTION DE LA LUMIÈRE	
direct	1
direct + indirect	2

5 LEISTUNG & STEUERUNG OUTPUT & CONTROL SORTIE & CONTRÔLE	
low output on/off	LO
low output DALI	LD
high output on/off	HO
high output DALI	HD
dynamic white DALI DT8	DW

6 GEHÄUSEFARBE HOUSING COLOUR COULEUR DU BOÎTIER	
silver RAL 9006	SI
white RAL 9016	WH
black RAL 9005	BL

7 DIFFUSOR DIFFUSER DIFFUSEUR	
opal	O
microprism	M

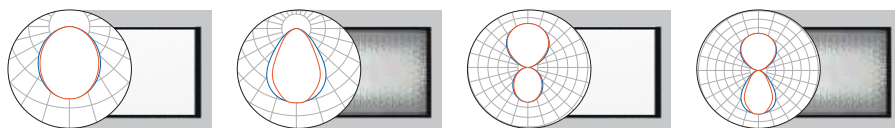
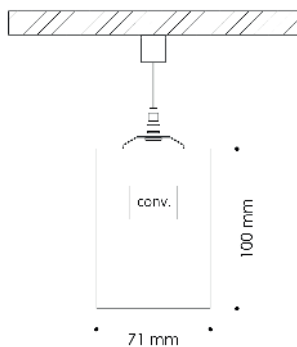

Size [mm]	opal direct		microprism direct		opal direct + indirect		microprism direct + indirect		direct	direct + indirect
	low output [lm] / [W]	high output [lm] / [W]	low output [lm] / [W]	high output [lm] / [W]	low output [lm] / [W]	high output [lm] / [W]	low output [lm] / [W]	high output [lm] / [W]	kg	kg
1.214	2.154 / 18,8	3.418 / 30,0	2.090 / 18,8	3.216 / 30,0	5.136 / 35,4	8.176 / 57,2	5.072 / 35,4	7.974 / 57,2	3,6	4,2
1.454	2.585 / 22,1	4.102 / 35,8	2.508 / 22,1	3.859 / 35,8	6.163 / 41,6	9.811 / 68,1	6.086 / 41,6	9.569 / 68,1	4,2	4,8
1.694	3.016 / 25,5	4.785 / 41,1	2.926 / 25,5	4.502 / 41,1	7.190 / 47,9	11.446 / 80,8	7.100 / 47,9	11.164 / 80,8	4,9	5,5
1.934	3.446 / 28,7	5.469 / 46,3	3.344 / 28,7	5.146 / 46,3	8.218 / 54,5	13.082 / 91,7	8.116 / 54,5	12.758 / 91,7	5,4	6,1
2.174	3.877 / 32,0	6.152 / 52,0	3.762 / 32,0	5.789 / 52,0	9.245 / 60,8	14.717 / 103,0	9.130 / 60,8	14.353 / 103,0	6,1	6,7
2.414	4.308 / 35,4	6.836 / 57,3	4.180 / 35,4	6.432 / 57,3	10.272 / 65,4	16.352 / 113,1	10.144 / 65,4	15.948 / 113,1	6,8	7,5
2.894	5.170 / 41,6	8.203 / 69,6	5.016 / 41,6	7.718 / 69,6	12.326 / 77,4	19.622 / 134,8	12.172 / 77,4	19.138 / 134,8	8,0	8,8
3.134	5.600 / 44,8	8.887 / 75,5	5.434 / 44,8	8.362 / 75,5	13.354 / 83,4	21.258 / 145,3	13.189 / 83,4	20.732 / 145,3	8,6	9,4
3.856	6.892 / 57,4	10.938 / 92,6	6.688 / 57,4	10.292 / 92,6	16.436 / 109,0	26.164 / 183,4	16.232 / 109,0	25.516 / 183,4	10,8	11,7

Alle Lumenangaben für 4000K, CRI>80, Microprisma ohne Opalfolie  
 All lumen values for 4000K, CRI>80, microprism without opal foil  
 Toutes les données de lumens pour 4000K, CRI>80, microprisme sans feuille opale



# RING50

HÄNGELEUCHE | PENDANT LUMINAIRE | LUMINAIRE SUSPENSION



Ringförmige LED-Hängeleuchte direktstrahlend oder direkt-indirektstrahlend. Lichtkanal aus gerolltem Aluminiumprofil mit einer Breite von 50 mm. Leuchte erhältlich in neun verschiedenen Durchmessern – 1220 und 1575 mm in einem Stück nahtlos verschweißt – die restlichen Größen (2020, 2595, 3090, 3535, 4070, 5050, 6075 mm) bestehend aus zwei bis neun gleich großen Segmenten. Oberfläche der Leuchte feinstruktur matt pulverbeschichtet ähnlich RAL 9016 weiß, RAL 9006 silber oder RAL 9005 schwarz – auf Anfrage in RAL nach Wahl. Diffusor wahlweise in PMMA opal oder PMMA klar mit mikroprismatischer Prägung für eine reduzierte Leuchtdichte (UGR<19). Leuchte inkl. weißem, rundem Baldachin mit transparentem Einspeisekabel sowie flexiblen Seilabhängern und Schnellspannern zur stufenlosen Regulierung der Montagehöhe. Der LED-Treiber ist im Leuchtengehäuse integriert – wahlweise als on/off oder DALI-Variante. Farbtemperaturen 2700K, 3000K, 4000K oder dynamisch Weiß (2700K–6500K) – Farbwiedergabe CRI>80 oder CRI>90 – Mac Adam ≤3. Weitere Steuerungsoptionen oder Lichtfarben auf Anfrage erhältlich. Außerdem ist die Integration vieler Komponenten, wie beispielsweise Notlicht oder Sensortechnologie, sowie eine Vielzahl weiterer Optionen möglich.

Ring-shaped pendant LED luminaire with direct beam or direct-indirect beam. Light channel made of rolled aluminium profile with a width of 50 mm. Luminaire available in nine different diameters - 1220 and 1575 mm seamlessly welded in one piece - the remaining sizes (2020, 2595, 3090, 3535, 4070, 5050, 6075 mm) consisting of two to nine equally sized segments. Surface of the luminaire fine structure matt powder coated similar to RAL 9016 white, RAL 9006 silver or RAL 9005 black - on request in RAL of choice. Diffuser either in PMMA opal or PMMA clear with microprismatic pattern for reduced luminance (UGR<19). Luminaire incl. white, round canopy with transparent feeding cable as well as flexible cord suspension and quick-release clamps for continuous adjustment of the mounting height. The LED driver is integrated in the luminaire housing - either as on/off or DALI version. Colour temperatures 2700K, 3000K, 4000K or dynamic white (2700K-6500K) - colour rendering CRI>80 or CRI>90 - Mac Adam ≤3. Further control options or light colours available on request. In addition, the integration of many components, such as emergency lighting or sensor technology, as well as a variety of other options is possible.

Suspension anneau LED à éclairage direct ou direct-indirect. Canal lumineux en profilé d'aluminium roulé d'une largeur de 50 mm. Luminaire disponible en neuf diamètres différents - 1220 et 1575 mm en une seule pièce soudée sans soudure - les autres tailles (2020, 2595, 3090, 3535, 4070, 5050, 6075 mm) se composent de deux à neuf segments de même taille. Surface du luminaire à structure fine matte revêtue par poudre similaire à RAL 9016 blanc, RAL 9006 argent ou RAL 9005 noir - sur demande en RAL au choix. Diffuseur au choix en PMMA opale ou en PMMA transparent avec gaufrage microprismatique pour un éblouissement réduit (UGR<19). Luminaire rond blanc avec un câble d'alimentation transparent ainsi que des câbles flexibles et des tendeurs rapides permettant de régler la hauteur de montage en continu. Le pilote LED est intégré dans le boîtier du luminaire - au choix en version on/off ou DALI. Températures de couleur 2700K, 3000K, 4000K ou blanc dynamique (2700K-6500K) - Rendu des couleurs CRI>80 ou CRI>90 - Mac Adam ≤3. Autres options de commande ou couleurs de lumière disponibles sur demande. En outre, l'intégration de nombreux composants, tels que l'éclairage de secours ou la technologie de détection, une multitude d'autres options sont possibles.

## ÜBERSICHT | OVERVIEW | VUE D'ENSEMBLE

### TECHNICAL DATA

2700K / 3000K / 4000K / 2700-6500K

CRI>80 / CRI>90

MacAdam ≤ 3

up to 136 lm/W

on-off / DALI

direct / direct + indirect

opal / microprism (UGR <19)

L80 B10 50.000h

### HOUSING COLOUR

schwarz | black | noir  
RAL 9005



silber | silver | argent  
RAL 9006



weiß | white | blanc  
RAL 9016



LED



3  
SDCM

IP  
20

CE

UK  
CA



RAL colour of your choice



Integration of emergency light



Design Cables



Contact us for more options...

**HÄNGELEUCHTE „RING50“**  
 PENDANT LUMINAIRE “RING50”  
 LUMINAIRE SUSPENSION « RING50 »

Bestellbeispiel | Example order | Exemple de commande

Standard Suspension, 6.075 mm, CRI>90, 4000K, direct + indirect, low output on/off, black, microprism

**RG50H-609402-LOBLM**

1 2 3 4 5 6 7 8

**1 ABHÄNGUNG**  
 SUSPENSION  
 SUSPENSION

Standard	<b>H</b>
Central (1.220 / 1.575 mm only)	<b>Z</b>
Y-Suspension (1.220 / 1.575 mm only)	<b>Y</b>

**2 DURCHMESSER**  
 DIAMETER  
 DIAMÈTRE

1.220 mm (no DW)	<b>12</b>
1.575 mm (no DW)	<b>15</b>
2.020 mm	<b>20</b>
2.595 mm	<b>25</b>
3.090 mm	<b>30</b>
3.535 mm	<b>35</b>
4.070 mm	<b>40</b>
5.050 mm	<b>50</b>
6.075 mm	<b>60</b>

**3 FARBWIEDERGABE**  
 COLOUR RENDERING  
 RENDU DES COULEURS

CRI>80	<b>8</b>
CRI>90	<b>9</b>

**4 FARBTEMPERATUR**  
 COLOUR TEMPERATURE  
 TEMPÉRATURE DE COULEUR

2700K (CRI>90 only)	<b>27</b>
3000K	<b>30</b>
4000K	<b>40</b>
2700-6500K (CRI>90 only)	<b>DW</b>

**5 LICHTVERTEILUNG**  
 LIGHT DISTRIBUTION  
 DISTRIBUTION DE LA LUMIÈRE

direct	<b>1</b>
direct + indirect	<b>2</b>

**6 LEISTUNG & STEUERUNG**  
 OUTPUT & CONTROL  
 SORTIE & CONTRÔLE

low output on/off	<b>LO</b>
low output DALI	<b>LD</b>
high output on/off	<b>HO</b>
high output DALI	<b>HD</b>
dynamic white DALI DT8	<b>DW</b>

**7 GEHÄUSEFARBE**  
 HOUSING COLOUR  
 COULEUR DU BOÎTIER

silver RAL 9006	<b>SI</b>
white RAL 9016	<b>WH</b>
black RAL 9005	<b>BL</b>

**8 DIFFUSOR**  
 DIFFUSER  
 DIFFUSEUR

opal	<b>O</b>
microprism	<b>M</b>

Code Standard: **H**

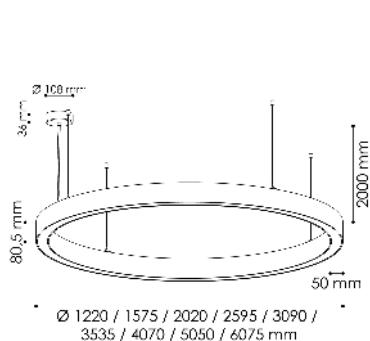

Code Central: **Z**

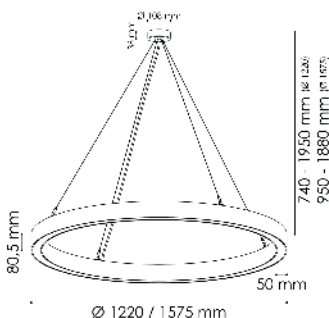

Code Y-Suspension: **Y**

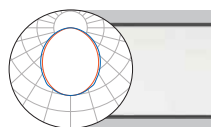
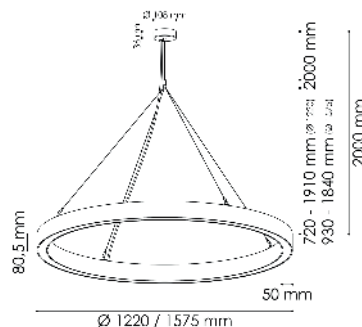

opal direct

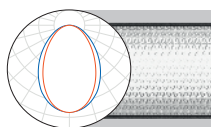

microprism direct

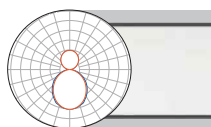

opal direct + indirect

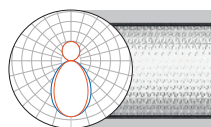

microprism direct + indirect

direct

direct + indirect

Size [mm]	low output [lm] / [W]		high output [lm] / [W]		low output [lm] / [W]		high output [lm] / [W]		direct [kg]	direct + indirect [kg]
	low output [lm] / [W]	high output [lm] / [W]	low output [lm] / [W]	high output [lm] / [W]	low output [lm] / [W]	high output [lm] / [W]	low output [lm] / [W]	high output [lm] / [W]		
Ø 1.220	4.888 / 38,3	8.376 / 66,3	5.026 / 38,3	8.616 / 66,3	7.402 / 55,3	12.688 / 95,1	7.539 / 55,3	12.920 / 95,1	9,9	10,5
Ø 1.575	6.110 / 51,2	10.470 / 86,6	6.283 / 51,2	10.770 / 86,6	9.252 / 71,9	15.860 / 122,1	9.424 / 71,9	16.150 / 122,1	12,8	13,6
Ø 2.020	7.943 / 65,0	13.611 / 113,2	8.168 / 65,0	14.001 / 113,2	12.028 / 93,2	20.618 / 161,6	12.251 / 93,2	20.995 / 161,6	16,5	17,5
Ø 2.595	10.387 / 85,0	17.799 / 147,9	10.681 / 85,0	18.309 / 147,9	15.728 / 118,8	26.962 / 207,5	16.021 / 118,8	27.455 / 207,5	21,1	22,4
Ø 3.090	12.220 / 102,4	20.940 / 178,0	12.566 / 102,4	21.540 / 178,0	18.504 / 143,4	31.720 / 250,0	18.848 / 143,4	32.300 / 250,0	25,2	26,7
Ø 3.535	14.053 / 120,7	24.081 / 209,0	14.451 / 120,7	24.771 / 209,0	21.280 / 164,6	36.478 / 286,5	21.675 / 164,6	37.145 / 286,5	28,8	30,6
Ø 4.070	15.886 / 137,0	27.222 / 238,0	16.336 / 137,0	28.002 / 238,0	24.055 / 186,8	41.236 / 325,5	24.502 / 186,8	41.990 / 325,5	33,2	35,2
Ø 5.050	20.163 / 172,0	34.551 / 298,0	20.734 / 172,0	35.541 / 298,0	30.532 / 238,0	52.338 / 414,6	31.099 / 238,0	53.295 / 414,6	41,1	43,6
Ø 6.075	23.829 / 205,5	40.833 / 357,0	24.504 / 205,5	42.003 / 357,0	36.083 / 280,3	61.854 / 488,3	36.754 / 280,3	62.985 / 488,3	49,5	52,5

Alle Lumenangaben für 4000K, CRI>80, Gehäusefarbe weiß

All lumen values for 4000K, CRI>80, housing colour white

Toutes les données de lumens pour 4000K, CRI>80, couleur du boîtier blanc

# RING50mute

HÄNGELEUCHE | PENDANT LUMINAIRE | LUMINAIRE SUSPENSION



Ringförmige LED-Hängeleuchte direktstrahlend oder direkt-indirektstrahlend. Lichtkanal aus gerolltem Aluminiumprofil mit einer Breite von 50 mm. Leuchte erhältlich in zwei verschiedenen Durchmessern mit integrierten Akustikelemente – 1220 und 1575 mm in einem Stück nahtlos verschweißt. Oberfläche der Leuchte feinstruktur matt pulverbeschichtet ähnlich RAL 9016 weiß, RAL 9006 silber oder RAL 9005 schwarz – auf Anfrage in RAL nach Wahl. Akustikelemente aus recyceltem PET in schwarz, hellgrau meliert, anthrazit meliert, burgunderrot oder olivgrün auswählbar. Diffusor wahlweise in PMMA opal oder PMMA klar mit mikroprismatischer Prägung für eine reduzierte Leuchtdichte (UGR<19). Leuchte inkl. weißem, rundem Baldachin mit transparentem Einspeisekabel sowie flexiblen Seilabhängern und Schnellspannern zur stufenlosen Regulierung der Montagehöhe. Der LED-Treiber ist im Leuchtengehäuse integriert – wahlweise als on/off oder DALI-Variante. Farbtemperaturen 2700K, 3000K oder 4000K – Farbwiedergabe CRI>80 oder CRI>90 – Mac Adam ≤3. Weitere Steuerungsoptionen oder Lichtfarben auf Anfrage erhältlich. Außerdem ist die Integration vieler Komponenten, wie beispielsweise Notlicht oder Sensortechnologie, sowie eine Vielzahl weiterer Optionen möglich.

Ring-shaped pendant LED luminaire with direct beam or direct-indirect beam. Light channel made of rolled aluminium profile with a width of 50 mm. Luminaire available in two different diameters with integrated acoustic elements - 1220 and 1575 mm seamlessly welded in one piece. Surface of the luminaire fine structure matt powder coated similar to RAL 9016 white, RAL 9006 silver or RAL 9005 black - on request in RAL of choice. Acoustic elements made of recycled PET available in black, light grey mottled, anthracite mottled, burgundy red or olive green. Diffuser either in PMMA opal or PMMA clear with microprismatic pattern for reduced luminance (UGR<19). Luminaire incl. white, round canopy with transparent feeding cable as well as flexible cord suspension and quick-release clamps for continuous adjustment of the mounting height. The LED driver is integrated in the luminaire housing - either as on/off or DALI version. Colour temperatures 2700K, 3000K or 4000K - colour rendering CRI>80 or CRI>90 - Mac Adam ≤3. Further control options or light colours available on request. In addition, the integration of many components, such as emergency lighting or sensor technology, as well as a variety of other options is possible.

Suspension anneau LED à éclairage direct ou direct-indirect. Canal lumineux en profilé d'aluminium roulé d'une largeur de 50 mm. Luminaire disponible en deux diamètres différents avec élément acoustique intégré - 1220 et 1575 mm en une seule pièce soudée sans soudure. Surface du luminaire à structure fine matte revêtue par poudre similaire à RAL 9016 blanc, RAL 9006 argent ou RAL 9005 noir - sur demande en RAL au choix. Éléments acoustiques fabriqués en PET recyclé en noir, gris clair chiné, anthracite chiné, rouge bordeaux ou vert olive au choix. Diffuseur au choix en PMMA opale ou en PMMA transparent avec gaufrage microprismatique pour un éblouissement réduit (UGR<19). Luminaire rond blanc avec un câble d'alimentation transparent ainsi que des câbles flexibles et des tendeurs rapides permettant de régler la hauteur de montage en continu. Le pilote LED est intégré dans le boîtier du luminaire - au choix en version on/off ou DALI. Températures de couleur 2700K, 3000K ou 4000K - Rendu des couleurs CRI>80 ou CRI>90 - Mac Adam ≤3. Autres options de commande ou couleurs de lumière disponibles sur demande. En outre, l'intégration de nombreux composants, tels que l'éclairage de secours ou la technologie de détection, une multitude d'autres options sont possibles.

## ÜBERSICHT | OVERVIEW | VUE D'ENSEMBLE

### TECHNICAL DATA

2700K / 3000K / 4000K

CRI>80 / CRI>90

MacAdam ≤ 3

up to 136 lm/W

on-off / DALI

direct / direct + indirect

opal / microprism (UGR <19)

L80 B10 50.000h

acoustic material - fire classification: B-s2, d0 (EN13501-1:3018)

### HOUSING COLOUR

schwarz | black | noir  
RAL 9005

silber | silver | argent  
RAL 9006

weiß | white | blanc  
RAL 9016



RAL colour of your choice



Integration of emergency light



Design Cables



Contact us for more options...

### COLOUR ACOUSTIC PANEL

schwarz | black | noir

hellgrau meliert | light grey mottled|  
gris clair chiné

anthrazit meliert |anthracite mottled|  
anthracite chiné

burgunderrot | burgundy red | rouge bourgogne

olivgrün | olive green | vert olive

**HÄNGELEUCHTE „RING50mute“**  
 PENDANT LUMINAIRE “RING50mute”  
 LUMINAIRE SUSPENSION « RING50mute »

Bestellbeispiel | Example order | Exemple de commande  
 Standard Suspension, 1.220 mm, CRI90, 4000K, direct, low output on/off, black, olive, microprism

**RG5MH-129401-LOBOM**

1 2 3 4 5 6 7 8 9

**1 ABHÄNGUNG**  
 SUSPENSION  
 SUSPENSION

Standard	<b>H</b>
Central	<b>Z</b>
Y-Suspension	<b>Y</b>

**2 DURCHMESSER**  
 DIAMETER  
 DIAMÈTRE

1.220 mm	<b>12</b>
1.575 mm	<b>15</b>

**3 FARBWIEDERGABE**  
 COLOUR RENDERING  
 RENDU DES COULEURS

CRI>80	<b>8</b>
CRI>90	<b>9</b>

**4 FARBTEMPERATUR**  
 COLOUR TEMPERATURE  
 TEMPÉRATURE DE COULEUR

2700K (CRI>90 only)	<b>27</b>
3000K	<b>30</b>
4000K	<b>40</b>

**5 LICHTVERTEILUNG**  
 LIGHT DISTRIBUTION  
 DISTRIBUTION DE LA LUMIÈRE

direct	<b>1</b>
direct + indirect	<b>2</b>

**6 LEISTUNG & STEUERUNG**  
 OUTPUT & CONTROL  
 SORTIE & CONTRÔLE

low output on/off	<b>LO</b>
low output DALI	<b>LD</b>
high output on/off	<b>HO</b>
high output DALI	<b>HD</b>

**7 GEHÄUSEFARBE**  
 HOUSING COLOUR  
 COULEUR DU BOÎTIER

silver RAL 9006	<b>S</b>
white RAL 9016	<b>W</b>
black RAL 9005	<b>B</b>

**8 FARBE AKUSTIKPLATTE**  
 COLOUR ACOUSTIC PANEL  
 COULEUR PANNEAU ACOUSTIQUE

black	<b>B</b>
light grey mottled	<b>S</b>
anthracite mottled	<b>A</b>
burgundy red	<b>R</b>
olive green	<b>O</b>

**9 DIFFUSOR**  
 DIFFUSER  
 DIFFUSEUR

opal	<b>O</b>
microprism	<b>M</b>

Code Standard: **H**

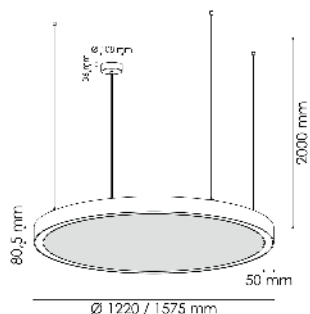

Code Central: **Z**

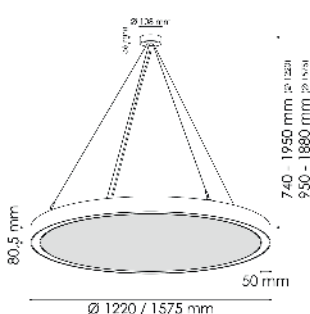

Code Y-Suspension: **Y**

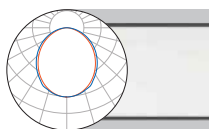
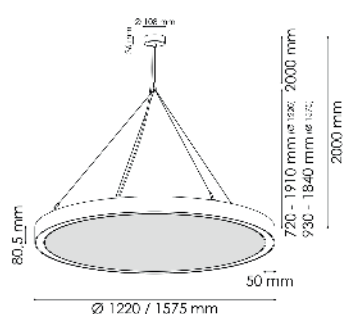

opal  
 direct

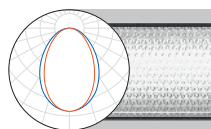

microprism  
 direct

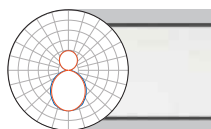

opal  
 direct + indirect

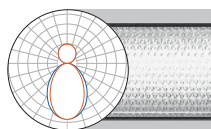

microprism  
 direct + indirect

direct

direct +  
 indirect

Size [mm]	low output [lm] / [W]	high output [lm] / [W]	low output [lm] / [W]	high output [lm] / [W]	low output [lm] / [W]	high output [lm] / [W]	low output [lm] / [W]	high output [lm] / [W]	KG	KG
Ø 1.220	4.888 / 38,3	8.376 / 66,3	5.026 / 38,3	8.616 / 66,3	7.402 / 55,3	12.688 / 95,1	7.539 / 55,3	12.920 / 95,1	14,0	14,6
Ø 1.575	6.110 / 51,2	10.470 / 86,6	6.283 / 51,2	10.770 / 86,6	9.252 / 71,9	15.860 / 122,1	9.424 / 71,9	16.150 / 122,1	19,8	20,6

Alle Lumenangaben für 4000K, CRI>80, Gehäusefarbe weiß  
 All lumen values for 4000K, CRI>80, housing colour white  
 Toutes les données de lumens pour 4000K, CRI>80, couleur du boîtier blanc

# FLEX50

HÄNGELEUCHE | PENDANT LUMINAIRE | LUMINAIRE SUSPENSION



**LED-Hängeleuchte als Segment** zur individuellen Kombination. Direktstrahlend oder direkt-indirektstrahlend. Lichtkanal aus gerolltem Aluminiumprofil mit einer Breite von 50 mm. Segmente erhältlich in 13 verschiedenen Varianten – zwei Stück als gerades Profil 980 oder 1960 mm – die restlichen Segmente sind als 40°, 45°, 60°- bzw. 90°-Stücke mit einem Mittenradius von 585 bis 3012,5 mm erhältlich. Oberfläche der Leuchte feinstruktur matt pulverbeschichtet ähnlich RAL 9016 weiß, RAL 9006 silber oder RAL 9005 schwarz – auf Anfrage in RAL nach Wahl. Diffusor wahlweise in PMMA opal oder PMMA klar mit mikroprismatischer Prägung für eine reduzierte Leuchtdichte (UGR<19). Leuchte inkl. weißem, rundem Baldachin mit transparentem Einspeisekabel sowie flexiblen Seilabhängern und Schnellspannern zur stufenlosen Regulierung der Montagehöhe. Der LED-Treiber ist im Leuchtgehäuse integriert – wahlweise als on/off oder DALI-Variante. Farbtemperaturen 2700K, 3000K, 4000K oder dynamisch Weiß (2700K–6500K) – Farbwiedergabe CRI>80 oder CRI>90 – Mac Adam ≤3. Weitere Steuerungsoptionen oder Lichtfarben auf Anfrage erhältlich. Außerdem ist die Integration vieler Komponenten, wie beispielsweise Notlicht oder Sensortechnologie, sowie eine Vielzahl weiterer Optionen möglich.

**Pendant LED luminaire as segment** for individual combination. Direct beam or direct-indirect beam. Light channel made of rolled aluminium profile with a width of 50 mm. Segments available in 13 different versions - two pieces as straight profile 980 or 1960 mm - the remaining segments are available as 40°, 45°, 60° or 90° pieces with a middle radius of 585 to 3012.5 mm. Surface of the luminaire fine structure matt powder coated similar to RAL 9016 white, RAL 9006 silver or RAL 9005 black - on request in RAL of choice. Diffuser either in PMMA opal or PMMA clear with microprismatic pattern for reduced luminance (UGR<19). Luminaire incl. white, round canopy with transparent feeding cable as well as flexible cord suspension and quick-release clamps for continuous adjustment of mounting height. The LED driver is integrated in the luminaire housing - either as on/off or DALI version. Colour temperatures 2700K, 3000K, 4000K or dynamic white (2700K-6500K) - colour rendering CRI>80 or CRI>90 - Mac Adam ≤3. Further control options or light colours available on request. In addition, the integration of many components, such as emergency lighting or sensor technology, as well as a variety of other options is possible.

**Luminaire LED suspendu sous segment** pour une combinaison individuelle. Éclairage direct ou éclairage direct-indirect. Canal lumineux en profilé d'aluminium roulé d'une largeur de 50 mm. Segments disponibles en 13 variantes différentes - deux pièces sous forme de profilé droit de 980 ou 1960 mm - les autres segments sont disponibles sous forme de pièces de 40°, 45°, 60° ou 90° avec un rayon central de 585 à 3012,5 mm. Surface du luminaire à structure fine matte revêtue par poudre similaire à RAL 9016 blanc, RAL 9006 argent ou RAL 9005 noir - sur demande en RAL au choix. Diffuseur au choix en PMMA opale ou en PMMA transparent avec gaufrage microprismatique pour un éblouissement réduit (UGR<19). Luminaire rond blanc avec un câble d'alimentation transparent ainsi que des câbles flexibles et des tendeurs rapides permettant de régler la hauteur de montage en continu. Le pilote LED est intégré dans le boîtier du luminaire - au choix sous forme de variante on/off ou DALI. Températures de couleur 2700K, 3000K, 4000K ou blanc dynamique (2700K-6500K) - Rendu des couleurs CRI>80 ou CRI>90 - Mac Adam ≤3. Autres options de commande ou couleurs de lumière disponibles sur demande. En outre, l'intégration de nombreux composants, tels que l'éclairage de secours ou la technologie de détection, une multitude d'autres options sont possibles.

## ÜBERSICHT | OVERVIEW | VUE D'ENSEMBLE

### TECHNICAL DATA

2700K / 3000K / 4000K / 2700-6500K

CRI>80 / CRI>90

MacAdam ≤ 3

up to 136 lm/W

on-off / DALI

direct / direct + indirect

opal / microprism (UGR <19)

L80 B10 50.000h

### HOUSING COLOUR

schwarz | black | noir  
RAL 9005

silber | silver | argent  
RAL 9006

weiß | white | blanc  
RAL 9016



RAL colour of your choice



Integration of emergency light



Design Cables



Contact us for more options...



**HÄNGELEUCHTE „FLEX50“**  
**PENDANT LUMINAIRE “FLEX50”**  
**LUMINAIRE SUSPENSION « FLEX50 »**

Bestellbeispiel | Example order | Exemple de commande  
 straight, 1.960 mm, CRI>90, 4000K, direct + indirect, low output on/off, black, microprism

**FX50H-L29402-LOBLM**

- 1 2 3 4 5 6 7

1 GRÖSSE SIZE TAILLE	
straight, L 980 mm	L1
straight, L 1.960 mm	L2
90°, R 585 mm (no DW)	19
90°, R 762,5 mm (no DW)	29
90°, R 985 mm	39
45°, R 1.272,5 mm	44
90°, R 1.272,5 mm	49
60°, R 1.520 mm	56
90°, R 1.520 mm	59
60°, R 1.742,5 mm	66
60°, R 2.010 mm	76
45°, R 2.500 mm	84
40°, R 3.012,5 mm	94

2 FARBWIEDERGABE COLOUR RENDERING RENDU DES COULEURS	
CRI>80	8
CRI>90	9

3 FARBTEMPERATUR COLOUR TEMPERATURE TEMPÉRATURE DE COULEUR	
2700K (CRI>90 only)	27
3000K	30
4000K	40
2700-6500K (CRI>90 only)	DW

4 LICHTVERTEILUNG LIGHT DISTRIBUTION DISTRIBUTION DE LA LUMIÈRE	
direct	1
direct + indirect	2

5 LEISTUNG & STEUERUNG OUTPUT & CONTROL SORTIE & CONTRÔLE	
low output on/off	LO
low output DALI	LD
high output on/off	HO
high output DALI	HD
dynamic white DALI DT8	DW

6 GEHÄUSEFARBE HOUSING COLOUR COULEUR DU BOÎTIER	
silver RAL 9006	SI
white RAL 9016	WH
black RAL 9005	BL

7 DIFFUSOR DIFFUSER DIFFUSEUR	
opal	O
microprism	M

ACCESSORIES	
END CAPS - 2 pcs.	
black	FX50H-EC-BL
silver	FX50H-EC-SI
white	FX50H-EC-WH
POWER FEEDING - 2.000 mm	
5-pole	FX50H-PF-5
3-pole	FX50H-PF-3

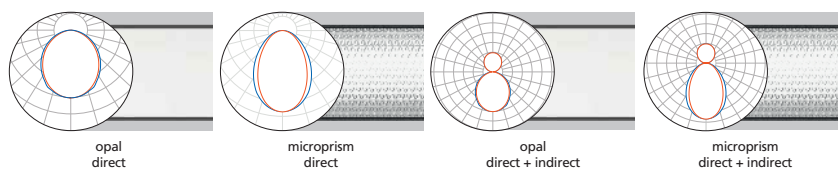
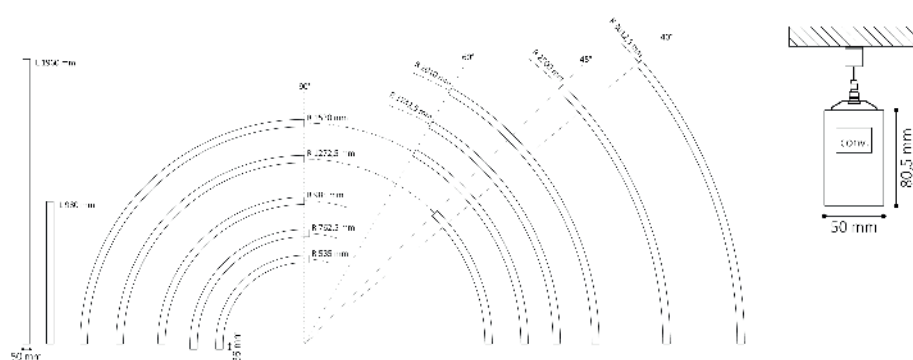

Size [mm]	opal direct		microprism direct		opal direct + indirect		microprism direct + indirect		direct	direct + indirect
	low output [lm] / [W]	high output [lm] / [W]	low output [lm] / [W]	high output [lm] / [W]	low output [lm] / [W]	high output [lm] / [W]	low output [lm] / [W]	high output [lm] / [W]	KG	KG
straight, L 980	1.222 / 11,2	2.094 / 18,1	1.257 / 11,2	2.153 / 18,1	1.850 / 15,1	3.171 / 24,5	1.885 / 15,1	3.230 / 24,5	2,5	2,7
straight, L 1.960	2.554 / 23,3	4.377 / 37,8	2.626 / 23,3	4.377 / 37,8	3.701 / 31,6	6.343 / 51,1	3.780 / 31,6	6.479 / 51,1	5,1	5,4
90°, R 585	1.224 / 9,6	2.096 / 16,6	1.256 / 11,2	2.156 / 16,6	1.850 / 13,8	3.171 / 23,8	1.885 / 13,8	3.230 / 23,8	2,5	2,6
90°, R 762,5	1.530 / 12,8	2.620 / 21,7	1.570 / 14,0	2.695 / 21,7	2.315 / 18,0	3.965 / 30,5	2.355 / 18,0	4.035 / 30,5	3,2	3,4
90°, R 985	1.836 / 16,3	3.144 / 29,6	1.884 / 16,8	3.234 / 29,6	2.778 / 23,3	4.758 / 40,4	2.826 / 23,3	4.842 / 40,4	4,1	4,4
45°, R 1.272,5	1.224 / 10,6	2.096 / 18,5	1.256 / 11,2	2.156 / 18,5	1.850 / 14,9	3.171 / 25,9	1.885 / 14,9	3.230 / 25,9	2,6	2,8
90°, R 1.272,5	2.448 / 21,3	4.192 / 37,0	2.512 / 22,4	4.312 / 37,0	3.704 / 29,7	6.344 / 51,9	3.768 / 29,7	6.456 / 51,9	5,3	5,6
60°, R 1.520	1.836 / 16,3	3.144 / 29,6	1.884 / 16,8	3.234 / 29,6	2.778 / 23,9	4.758 / 41,7	2.826 / 23,9	4.842 / 41,7	4,2	4,5
90°, R 1.520	3.060 / 25,6	5.240 / 44,5	3.140 / 28,0	5.390 / 44,5	4.630 / 35,8	7.930 / 62,5	4.710 / 35,8	8.070 / 62,5	6,3	6,7
60°, R 1.742,5	2.142 / 20,1	3.668 / 34,8	2.198 / 19,6	3.773 / 34,8	3.241 / 27,4	5.551 / 47,8	3.297 / 27,4	5.649 / 47,8	4,8	5,1
60°, R 2.010	2.754 / 22,8	4.716 / 39,7	2.826 / 25,2	4.851 / 39,7	4.167 / 31,1	7.137 / 54,3	4.239 / 31,1	7.263 / 54,3	5,5	5,9
45°, R 2.500	2.448 / 21,5	4.192 / 37,2	2.512 / 22,4	4.312 / 37,2	3.704 / 29,8	6.344 / 51,8	3.768 / 29,8	6.456 / 51,8	5,1	5,5
40°, R 3.012,5	2.754 / 22,8	4.716 / 39,7	2.826 / 25,2	4.851 / 39,7	4.167 / 31,1	7.137 / 54,3	4.239 / 31,1	7.263 / 54,3	5,5	5,8

Alle Lumenangaben für 4000K, CRI>80, Gehäusefarbe weiß  
 All lumen values for 4000K, CRI>80, housing colour white  
 Toutes les données de lumens pour 4000K, CRI>80, couleur du boîtier blanc



# OVOID50

HÄNGELEUCHE | PENDANT LUMINAIRE | LUMINAIRE SUSPENSION



**LED-Hängeleuchte OVOID50** als oval-förmige Standardleuchte. Direktstrahlend. Lichtkanal aus gerolltem Aluminiumprofil mit einer Breite von 50 mm. Ovale Standardleuchte erhältlich mit den Abmessungen 1.160 mm x 850 mm oder 2.500 mm x 1.800mm. Oberfläche der Leuchte feinstruktur matt pulverbeschichtet ähnlich RAL 9016 weiß, RAL 9006 silber oder RAL 9005 schwarz – auf Anfrage in RAL nach Wahl. Diffusor wahlweise in PMMA opal oder PMMA mit mikroprismatischer Prägung für eine reduzierte Leuchtdichte (UGR<19). Leuchte inkl. weißem, rundem Baldachin mit transparentem Einspeisekabel sowie flexiblen Seilabhängern und Schnellspannern zur stufenlosen Regulierung der Montagehöhe. Der LED-Treiber ist im Leuchtgehäuse integriert – wahlweise als on/off oder DALI-Variante. Farbtemperaturen 2700K, 3000K, 4000K oder dynamisch Weiß (2700K–6500K) – Farbwiedergabe CRI>80 oder CRI>90 – Mac Adam ≤3. Weitere Steuerungsoptionen oder Lichtfarben auf Anfrage erhältlich. Außerdem ist die Integration vieler Komponenten, wie beispielsweise Notlicht oder Sensortechnologie, sowie eine Vielzahl weiterer Optionen möglich.

**Pendant LED luminaire** in an oval-shaped standard design. Direct beam. Light channel made of rolled aluminium profile with a width of 50 mm. Oval standard luminaire available in dimensions 1.160 mm x 850 mm or 2.500 mm x 1.800 mm. Surface of the luminaire fine structure matt powder coated similar to RAL 9016 white, RAL 9006 silver or RAL 9005 black - on request in RAL of choice. Diffuser either in PMMA opal or PMMA clear with microprismatic pattern for reduced luminance (UGR<19). Luminaire incl. white, round canopy with transparent feeding cable as well as flexible cord suspension and quick-release clamps for continuous adjustment of mounting height. The LED driver is integrated in the luminaire housing - either as on/off or DALI version. Colour temperatures 2700K, 3000K, 4000K or dynamic white (2700K-6500K) - colour rendering CRI>80 or CRI>90 - Mac Adam ≤3. Further control options or light colours available on request. In addition, the integration of many components, such as emergency lighting or sensor technology, as well as a variety of other options is possible.

**Luminaire LED suspendu** au design standard en forme ovale. Éclairage direct de la surface. Luminaire standard ovale disponible dans les dimensions 1.160 mm x 850 mm ou 2.500 mm x 1.800 mm. Surface du luminaire à structure fine matte revêtue par poudre similaire à RAL 9016 blanc, RAL 9006 argent ou RAL 9005 noir - sur demande en RAL au choix. Diffuseur au choix en PMMA opale ou en PMMA transparent avec gaufrage microprismatique pour un éblouissement réduit (UGR<19). Luminaire rond blanc avec un câble d'alimentation transparent ainsi que des câbles flexibles et des tendeurs rapides permettant de régler la hauteur de montage en continu. Le driver LED est intégré dans le boîtier du luminaire - au choix en version on/ off ou DALI. Températures de couleur 2700K, 3000K, 4000K ou blanc dynamique (2700K-6500K) - Rendu des couleurs CRI>80 ou CRI>90 - Mac Adam ≤3. Autres options de commande ou couleurs de lumière disponibles sur demande. En

## ÜBERSICHT | OVERVIEW | VUE D'ENSEMBLE

### TECHNICAL DATA

2700K / 3000K / 4000K / 2700-6500K

CRI>80 / CRI>90

MacAdam ≤ 3

up to 120 lm/W

on-off / DALI

direct / direct + indirect

opal / microprism (UGR <19)

L80 B10 50.000h

### HOUSING COLOUR

schwarz | black | noir  
RAL 9005

silber | silver | argent  
RAL 9006

weiß | white | blanc  
RAL 9016



RAL colour of your choice



Integration of emergency light

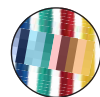

Design Cables



Contact us for more options...

**HÄNGELEUCHTE „OVOID50“**  
 PENDANT LUMINAIRE “OVOID50”  
 LUMINAIRE SUSPENSION « OVOID50 »

Bestellbeispiel | Example order | Exemple de commande  
 1160x850 mm, CRI90, 4000K, direct/indirect, low output on/off, black, microprism

**OV50H-119402-LOBLM**

1 2 3 4 5 6 7

**1 GRÖSSE**  
 SIZE  
 TAILLE

L 1160 mm, W 850 mm	<b>11</b>
L 2500 mm, W 1800 mm	<b>25</b>

**2 FARBWIEDERGABE**  
 COLOUR RENDERING  
 RENDU DES COULEURS

CRI>80	<b>8</b>
CRI>90	<b>9</b>

**3 FARBTEMPERATUR**  
 COLOUR TEMPERATURE  
 TEMPÉRATURE DE COULEUR

2700K (CRI>90 only)	<b>27</b>
3000K	<b>30</b>
4000K	<b>40</b>
2700-6500K (CRI>90 only)	<b>DW</b>

**4 LICHTVERTEILUNG**  
 LIGHT DISTRIBUTION  
 DISTRIBUTION DE LA LUMIÈRE

direct	<b>1</b>
direct + indirect	<b>2</b>

**5 LEISTUNG & STEUERUNG**  
 OUTPUT & CONTROL  
 SORTIE & CONTRÔLE

low output on/off	<b>LO</b>
low output DALI	<b>LD</b>
high output on/off	<b>HO</b>
high output DALI	<b>HD</b>
dynamic white DALI DT8	<b>DW</b>

**6 GEHÄUSEFARBE**  
 HOUSING COLOUR  
 COULEUR DU BOÎTIER

silver RAL 9006	<b>SI</b>
white RAL 9016	<b>WH</b>
black RAL 9005	<b>BL</b>

**7 ABDECKUNG**  
 COVER  
 COUVERTURE

opal	<b>O</b>
microprism	<b>M</b>

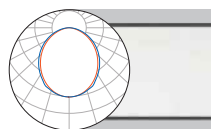
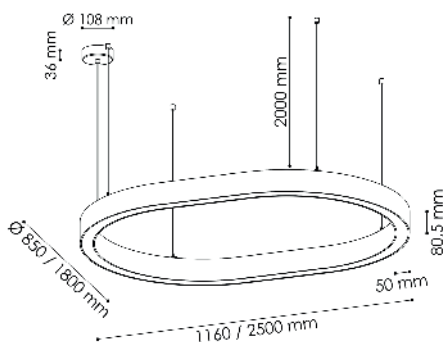

opal direct

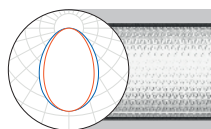

microprism direct

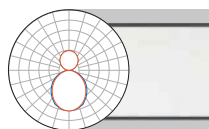

opal direct + indirect

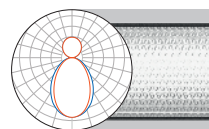

microprism direct + indirect

Size [mm]	opal direct		microprism direct		opal direct + indirect		microprism direct + indirect		direct	direct + indirect
	low output [lm] / [W]	high output [lm] / [W]	low output [lm] / [W]	high output [lm] / [W]	low output [lm] / [W]	high output [lm] / [W]	low output [lm] / [W]	high output [lm] / [W]	KG	KG
1.160 x 850	3.455 / 32,5	5.527 / 57,0	3.656 / 32,5	5.899 / 57,0	7.692 / 65,6	13.758 / 122,1	7.893 / 65,6	14.129 / 122,1	8,3	8,8
2.500 x 1.800	7.539 / 71,0	12.060 / 124,4	7.977 / 71,0	12.869 / 124,4	16.782 / 143,4	30.017 / 266,4	17.220 / 143,4	30.827 / 266,4	17,7	18,8

Alle Lumenangaben für 4000K, CRI>80, Gehäusefarbe weiß  
 All lumen values for 4000K, CRI>80, housing colour white  
 Toutes les données de lumens pour 4000K, CRI>80, couleur du boîtier blanc

# ROUND90

HÄNGELEUCHE | PENDANT LUMINAIRE | LUMINAIRE SUSPENSION



**Runde LED-Flächenleuchte zur Hängemontage.** Direktstrahlend oder direkt-indirektstrahlend. Gehäuse aus gerolltem Aluminiumprofil, nahtlos verschweißt. Fertigung der Leuchte in vier Durchmessern: 350, 450, 650 und 950 mm mit einer Gesamthöhe von 90 mm. Oberfläche pulverbeschichtet feinstruktur matt ähnlich RAL 9016 weiß, RAL 9006 silber oder RAL 9005 schwarz – auf Anfrage in RAL nach Wahl. Die durchdachte Konstruktion der Leuchte ermöglicht ein Design in zahlreichen Farbkombinationen – zwischen Gehäusefarbe und Dekorring kann beliebig kombiniert werden. Um der Leuchtenfamilie neben den Standardfarben einen dekorativen Touch zu verleihen, steht der Dekorring auch in den strukturierten Spezialoberflächen schlaggold, schlagsilber und schlagbronze zur Auswahl. Diffusor in PMMA wahlweise opal, mikroprismatisch inkl. Streufolie oder nur mikroprismatisch (office special) für eine reduzierte Leuchtdichte (UGR<19). Leuchte inkl. weißem, rundem Deckenbaldachin mit transparentem Einspeisekabel. Abhängung wählbar zwischen einem individuell kürzbaren starren Pendenrohr (R) oder den 3 Seilabhängungen Standard (H), Zentral (Z) oder Y-Abhängung (Y). Schnellspanner bei den Seilvarianten an der Leuchte zur stufenlosen Regulierung der Montagehöhe. Pendenrohr und dazugehöriger Baldachin in Gehäusefarbe. Der LED-Treiber ist im Leuchtengehäuse integriert – wahlweise als on/off oder DALI-Variante. Farbtemperaturen 2700K, 3000K, 4000K oder dynamisch Weiß (2700K-6500K) – Farbwiedergabe CRI>80 oder CRI>90 – Mac Adam ≤3. Weitere Steuerungsoptionen oder Lichtfarben auf Anfrage möglich. Außerdem ist die Integration vieler Komponenten, wie beispielsweise Notlicht oder Sensortechnologie, sowie eine Vielzahl weiterer Optionen möglich.

**Round LED luminaire for pendant mounting.** Direct beam or direct-indirect beam. Housing made of rolled aluminium profile, seamlessly welded. Luminaire manufactured in four diameters: 350, 450, 650 and 950 mm with a total height of 90 mm. Surface powder coated fine structure matt similar to RAL 9016 white, RAL 9006 silver or RAL 9005 black - on request in RAL of choice. The sophisticated construction of the luminaire allows a design in numerous colour combinations - any combination of housing colour and decorative ring is possible. To give the luminaire family a decorative touch in addition to the standard colours, the decorative ring is also available in the special textured surfaces beaten gold, beaten silver and beaten bronze. Diffuser in PMMA either opal, microprism incl. diffuser foil or only microprism (office special) for reduced luminance (UGR<19). Luminaire incl. white, round ceiling canopy with transparent feeding cable. Suspension can be selected between an individually shortenable stiff suspension rod (R) or the 3 wire suspensions standard (H), central (Z) or Y-suspension (Y). Quick-release clamps on the cable versions on the luminaire for infinitely variable adjustment of the mounting height. Suspension rod and matching canopy in the same colour as the housing. The LED driver is integrated in the luminaire housing - either as on/off or DALI version. Colour temperatures 2700K, 3000K, 4000K or dynamic white (2700K-6500K) - colour rendering CRI>80 or CRI>90 - Mac Adam ≤3. Further control options or light colours available on request. In addition, the integration of many components, such as emergency lighting or sensor technology, as well as a variety of other options is possible.

**Suspension runde LED.** Éclairage direct ou éclairage direct-indirect. Boîtier en profilé d'aluminium roulé, soudé sans soudure. Fabrication du luminaire en quatre diamètres : 350, 450, 650 et 950 mm avec une hauteur totale de 90 mm. Surface revêtue par poudre à structure fine mate similaire à RAL 9016 blanc, RAL 9006 argent ou RAL 9005 noir - sur demande en RAL au choix. La construction bien pensée du luminaire permet un design dans de nombreuses combinaisons de couleurs - il est possible de combiner à volonté entre la couleur du boîtier et l'anneau décoratif. Pour donner à la famille de luminaires une touche décorative en plus des couleurs standard, l'anneau décoratif est également disponible dans les surfaces spéciales structurées or choc, argent choc et bronze choc. Diffuseur en PMMA au choix opale, microprismatique y compris feuille diffusante ou uniquement microprismatique (office special) pour un éblouissement réduit (UGR<19). de plafond rond blanc avec câble d'alimentation transparent. Suspension au choix entre un tube de rigide pouvant être raccourci individuellement (R) ou par câble : standard (H), centrale (Z) ou en Y (Y). Tendeur rapide pour les variantes de câble sur le luminaire pour un réglage en continu de la hauteur de montage. Tube de suspension correspondant à la couleur du boîtier. Le driver LED est intégré dans le boîtier du luminaire - au choix en version on/off ou DALI. Températures de couleur 2700K, 3000K, 4000K ou blanc dynamique (2700K-6500K) - Rendu des couleurs CRI>80 ou CRI>90 - Mac Adam ≤3. Autres options de commande ou couleurs de lumière possibles sur demande. En outre, l'intégration de nombreux composants, tels que l'éclaira.

## ÜBERSICHT | OVERVIEW | VUE D'ENSEMBLE

TECHNICAL DATA	
2700K / 3000K / 4000K / 2700-6500K	
CRI>80 / CRI>90	
MacAdam ≤ 3	
up to 174 lm/W	
on-off / DALI	
direct / direct + indirect	
opal / microprism / office special (UGR <19)	
L80 B10 50.000h	
HOUSING COLOUR	
schwarz   black   noir RAL 9005	
silber   silver   argent RAL 9006	
weiß   white   blanc RAL 9016	

RAL colour of your choice	Integration of Multisensor	Integration of emergency light	Design Cables	Contact us for more options...			
DECORATION RING COLOUR							
silber hochglanz   silver specular   argenté brillant		gold hochglanz   gold specular   doré brillant					
silber matt   silver matt   argenté mat		bronze hochglanz   bronze specular   bronze brillant					
schwarz hochglanz   black specular   noir brillant		titan hochglanz   titan specular   titan brillant					

**HÄNGELEUCHE „ROUND90“**  
 PENDANT LUMINAIRE "ROUND90"  
 LUMINAIRE SUSPENSION « ROUND90 »

Bestellbeispiel | Example order | Exemple de commande

Y-Suspension, 350 mm, CRI>90, 4000K, direct, low output on/off, black, beaten gold, microprism

**RO90Y-359401-LOBGM**

1 2 3 4 5 6 7 8 9

<b>1</b>	<b>ABHÄNGUNG</b> SUSPENSION SUSPENSION	
	Standard	<b>H</b>
	Central	<b>Z</b>
	Y-Suspension	<b>Y</b>
	Rod Suspension	<b>R</b>
<b>2</b>	<b>DURCHMESSER</b> DIAMETER DIAMÈTRE	
	350 mm	<b>35</b>
	450 mm	<b>45</b>
	650 mm	<b>65</b>
	950 mm	<b>95</b>
<b>3</b>	<b>FARBWIEDERGABE</b> COLOUR RENDERING RENDU DES COULEURS	
	CRI>80	<b>8</b>
	CRI>90	<b>9</b>

<b>4</b>	<b>FARBTEMPERATUR</b> COLOUR TEMPERATURE TEMPÉRATURE DE COULEUR	
	2700K (CRI>90 only)	<b>27</b>
	3000K	<b>30</b>
	4000K	<b>40</b>
	2700-6500K (CRI>90 only)	<b>DW</b>
<b>5</b>	<b>LICHTVERTEILUNG</b> LIGHT DISTRIBUTION DISTRIBUTION DE LA LUMIÈRE	
	direct	<b>1</b>
	direct + indirect	<b>2</b>
<b>6</b>	<b>LEISTUNG &amp; STEUERUNG</b> OUTPUT & CONTROL SORTIE & CONTRÔLE	
	low output on/off	<b>LO</b>
	low output DALI	<b>LD</b>
	high output on/off	<b>HO</b>
	high output DALI	<b>HD</b>
	dynamic white DALI DT8	<b>DW</b>

<b>7</b>	<b>GEHÄUSEFARBE</b> HOUSING COLOUR COULEUR DU BOÎTIER	
	black RAL 9005	<b>B</b>
	silver RAL 9006	<b>S</b>
	white RAL 9016	<b>W</b>
<b>8</b>	<b>DEKORRING FARBE</b> DECORATION RING COLOUR BAGUE DÉCORATIVE COULEUR	
	black RAL 9005	<b>B</b>
	silver RAL 9006	<b>S</b>
	white RAL 9016	<b>W</b>
	beaten gold	<b>G</b>
	beaten silver	<b>A</b>
	beaten bronze	<b>C</b>
<b>9</b>	<b>DIFFUSOR</b> DIFFUSER DIFFUSEUR	
	opal	<b>O</b>
	microprism	<b>M</b>
	office special	<b>B</b>

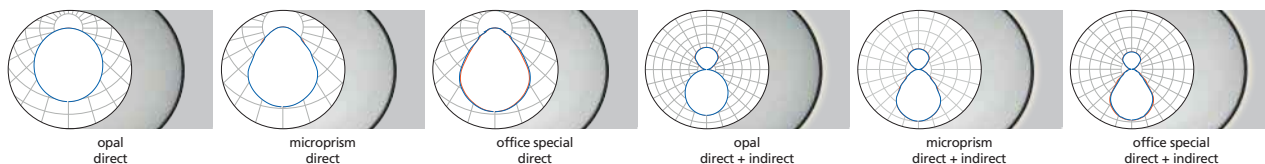
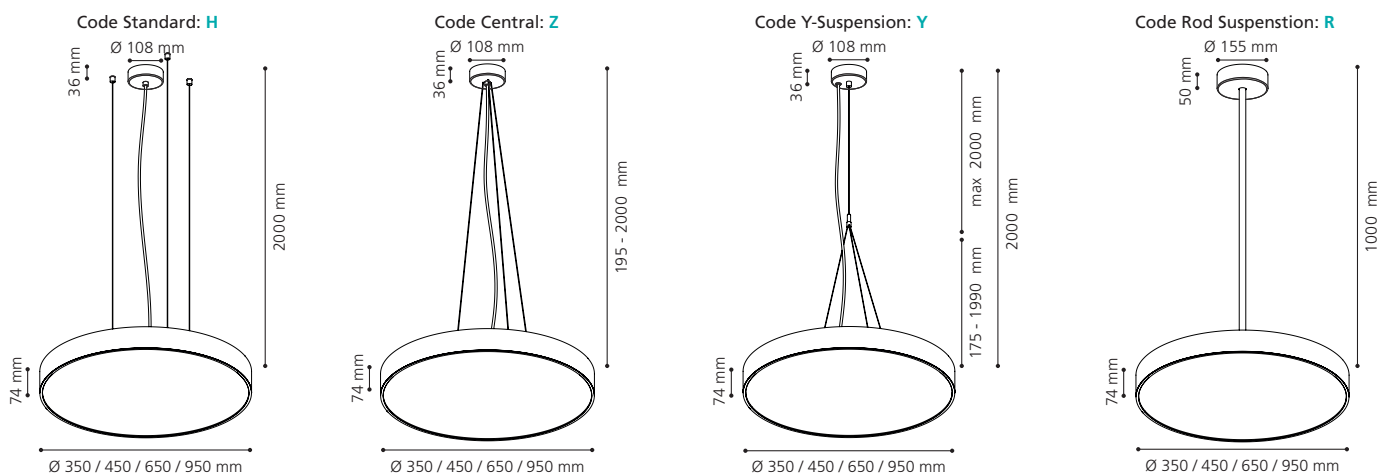

Size [mm]	opal direct		microprism direct		office special direct		opal direct + indirect		microprism direct + indirect		office special direct + indirect		KG
	low output [lm] / [W]	high output [lm] / [W]	low output [lm] / [W]	high output [lm] / [W]	low output [lm] / [W]	high output [lm] / [W]	low output [lm] / [W]	high output [lm] / [W]	low output [lm] / [W]	high output [lm] / [W]	low output [lm] / [W]	high output [lm] / [W]	
Ø 350	1.158 / 8,5	1.826 / 12,9	1.077 / 8,5	1.697 / 12,9	1.213 / 8,5	1.905 / 12,9	1.747 / 11,9	2.625 / 17,5	1.661 / 11,9	2.493 / 17,5	1.795 / 11,9	2.691 / 17,5	3,8
Ø 450	2.258 / 15,5	3.561 / 23,5	2.099 / 15,5	3.309 / 23,5	2.364 / 15,5	3.715 / 23,5	3.207 / 20,7	4.820 / 30,3	3.050 / 20,7	4.577 / 30,2	3.296 / 20,7	4.942 / 30,3	5,0
Ø 650	4.114 / 27,2	6.489 / 41,3	3.825 / 27,2	6.029 / 41,3	4.309 / 27,2	6.770 / 41,3	5.534 / 35,2	8.317 / 51,3	5.263 / 35,2	7.897 / 51,3	5.687 / 35,2	8.526 / 51,3	8,0
Ø 950	9.102 / 56,7	14.360 / 86,0	8.466 / 56,7	13.342 / 86,0	9.535 / 56,7	14.982 / 86,0	11.036 / 67,7	16.585 / 99,1	10.494 / 67,7	15.748 / 99,1	11.342 / 67,7	17.004 / 99,1	19,5

Alle Lumenangaben für 4000K, CRI>80, Gehäusefarbe weiß  
 All lumen values for 4000K, CRI>80, housing colour white  
 Toutes les données de lumens pour 4000K, CRI>80, couleur du boîtier blanc

# SQUARE90

HÄNGELEUCHTE | PENDANT LUMINAIRE | LUMINAIRE SUSPENSION



**Quadratische LED-Flächenleuchte zur Hängemontage.** Direktstrahlend oder direkt-indirektstrahlend. Gehäuse aus Aluminiumprofil, nahtlos verschweißt. Fertigung der Leuchte in vier Größen: 350, 450, 650 und 950 mm mit einer Gesamthöhe von 90 mm. Oberfläche pulverbeschichtet feinstruktur matt ähnlich RAL 9016 weiß, RAL 9006 silber oder RAL 9005 schwarz – auf Anfrage in RAL nach Wahl. Die durchdachte Konstruktion der Leuchte ermöglicht ein Design in zahlreichen Farbkombinationen – zwischen Gehäusefarbe und Dekorring kann beliebig kombiniert werden. Um der Leuchtenfamilie neben den Standardfarben einen dekorativen Touch zu verleihen, steht der Dekorring auch in den strukturierten Spezialoberflächen schlaggold, schlagsilber und schlagbronze zur Auswahl. Diffusor in PMMA wahlweise opal, mikroprismatisch inkl. Streufolie oder nur mikroprismatisch (office special) für eine reduzierte Leuchtdichte (UGR<19). Leuchte inkl. weißem, rundem Deckenbaldachin mit transparentem Einspeisekabel. Abhängung wählbar zwischen einem individuell kürzbaren starren Pendelrohr (R) oder den 3 Seilabhängungen Standard (H), Zentral (Z) oder Y-Abhängung (Y). Schnellspanner bei den Seilvarianten an der Leuchte zur stufenlosen Regulierung der Montagehöhe. Pendelrohr und dazugehöriger Baldachin in Gehäusefarbe. Der LED-Treiber ist im Leuchtgehäuse integriert – wahlweise als on/off oder DALI-Variante. Farbtemperaturen 2700K, 3000K, 4000K oder dynamisch Weiß (2700K-6500K) – Farbwiedergabe CRI>80 oder CRI>90 – Mac Adam ≤3. Weitere Steuerungsoptionen oder Lichtfarben auf Anfrage möglich. Außerdem ist die Integration vieler Komponenten, wie beispielsweise Notlicht oder Sensortechnologie, sowie eine Vielzahl weiterer Optionen möglich.

**Square LED luminaire for pendant mounting.** Direct beam or direct-indirect beam. Housing made of aluminium profile, seamlessly welded. Luminaire manufactured in four sizes: 350, 450, 650 and 950 mm with a total height of 90 mm. Surface powder coated fine structure matt similar to RAL 9016 white, RAL 9006 silver or RAL 9005 black - on request in RAL of choice. The sophisticated construction of the luminaire allows a design in numerous colour combinations - any combination of housing colour and decorative ring is possible. To give the luminaire family a decorative touch in addition to the standard colours, the decorative ring is also available in the special textured surfaces of beaten gold, beaten silver and beaten bronze. Diffuser in PMMA either opal, microprism incl. diffuser foil or only microprism (office special) for reduced luminance (UGR<19). Luminaire incl. white, round ceiling canopy with transparent feeding cable. Suspension can be selected between an individually shortenable stiff suspension rod (R) or the 3 wire suspensions standard (H), central (Z) or Y-suspension (Y). Quick-release clamps on the cable versions on the luminaire for infinitely variable adjustment of the mounting height. Suspension rod and matching canopy in the same colour as the housing. The LED driver is integrated in the luminaire housing - either as on/off or DALI version. Colour temperatures 2700K, 3000K, 4000K or dynamic white (2700K-6500K) - colour rendering CRI>80 or CRI>90 - Mac Adam ≤3. Further control options or light colours available on request. In addition, the integration of many components, such as emergency lighting or sensor technology, as well as a variety of other options is possible.

**Suspension carrée LED.** Éclairage direct ou direct-indirect. Boîtier en profilé d'aluminium, soudé sans soudure. Fabrication du luminaire en quatre dimensions : 350, 450, 650 et 950 mm avec une hauteur totale de 90 mm. Surface revêtue par poudre à structure fine mate similaire à RAL 9016 blanc, RAL 9006 argent ou RAL 9005 noir - sur demande en RAL au choix. La construction bien pensée du luminaire permet un design dans de nombreuses combinaisons de couleurs - il est possible de combiner à volonté entre la couleur du boîtier et l'anneau décoratif. Pour donner à la famille de luminaires une touche décorative en plus des couleurs standard, l'anneau décoratif est également disponible dans les surfaces spéciales structurées or choc, argent choc et bronze choc. Diffuseur en PMMA au choix opale, microprismatique y compris feuille diffuseuse ou uniquement microprismatique (office special) pour un éblouissement réduit (UGR<19). Luminaire de plafond rond blanc avec câble d'alimentation transparent. Suspension au choix entre un tube rigide pouvant être raccourci individuellement (R) ou par câble : standard (H), centrale (Z) ou en Y (Y). Tendeur rapide pour les variantes de câble sur le luminaire pour un réglage en continu de la hauteur de montage. Tube de suspension correspondant dans la couleur du boîtier. Le driver LED est intégré dans le boîtier du luminaire - au choix en version on/off ou DALI. Températures de couleur 2700K, 3000K, 4000K ou blanc dynamique (2700K-6500K) - Rendu des couleurs CRI>80 ou CRI>90 - Mac Adam ≤3. Autres options de commande ou couleurs de lumière possibles sur demande. En outre, l'intégration de nombreux composants, tels que l'éclairage de secours ou la technologie des capteurs, une multitude d'autres options sont possibles.

## ÜBERSICHT | OVERVIEW | VUE D'ENSEMBLE

TECHNICAL DATA	
2700K / 3000K / 4000K / 2700-6500K	
CRI>80 / CRI>90	
MacAdam ≤ 3	
up to 175 lm/W	
on-off / DALI	
direct / direct + indirect	
opal / microprism / office special (UGR <19)	
L80 B10 50.000h	
HOUSING COLOUR	
schwarz   black   noir RAL 9005	
silber   silver   argent RAL 9006	
weiß   white   blanc RAL 9016	

RAL colour of your choice	Integration of Multisensor	Integration of emergency light	Design Cables	Contact us for more options...			
DECORATION RING COLOUR							
schwarz   black   noir RAL 9005		schlaggold   beaten gold   or texturés					
silber   silver   argent RAL 9006		schlagsilber   beaten silver   argent texturés					
weiß   white   blanc RAL 9016		schlagbronze   beaten bronze   bronze texturés					

**HÄNGELEUCHTE „SQ90“**  
**PENDANT LUMINAIRE “SQ90”**  
**LUMINAIRE SUSPENSION « SQ90 »**

Bestellbeispiel | Example order | Exemple de commande

Y-Suspension, 350 x 350 mm, CRI>90, 4000K, direct, low output on/off, white, beaten gold, microprism

**SQ90Y-359401-LOWGM**

1 2 3 4 5 6 7 8 9

<b>1</b>	<b>ABHÄNGUNG</b> SUSPENSION SUSPENSION	
	Standard	<b>H</b>
	Central	<b>Z</b>
	Y-Suspension	<b>Y</b>
	Rod Suspension	<b>R</b>
<b>2</b>	<b>GRÖSSE</b> SIZE TAILLE	
	350 x 350 mm	<b>35</b>
	450 x 450 mm	<b>45</b>
	650 x 650 mm	<b>65</b>
	950 x 950 mm	<b>95</b>
<b>3</b>	<b>FARBWIEDERGABE</b> COLOUR RENDERING RENDU DES COULEURS	
	CRI>80	<b>8</b>
	CRI>90	<b>9</b>

<b>4</b>	<b>FARBTEMPERATUR</b> COLOUR TEMPERATURE TEMPÉRATURE DE COULEUR	
	2700K (CRI>90 only)	<b>27</b>
	3000K	<b>30</b>
	4000K	<b>40</b>
	2700-6500K (CRI>90 only)	<b>DW</b>
<b>5</b>	<b>LICHTVERTEILUNG</b> LIGHT DISTRIBUTION DISTRIBUTION DE LA LUMIÈRE	
	direct	<b>1</b>
	direct + indirect	<b>2</b>
<b>6</b>	<b>LEISTUNG &amp; STEUERUNG</b> OUTPUT & CONTROL SORTIE & CONTRÔLE	
	low output on/off	<b>LO</b>
	low output DALI	<b>LD</b>
	high output on/off	<b>HO</b>
	high output DALI	<b>HD</b>
	dynamic white DALI DT8	<b>DW</b>

<b>7</b>	<b>GEHÄUSEFARBE</b> HOUSING COLOUR COULEUR DU BOÎTIER	
	black RAL 9005	<b>B</b>
	silver RAL 9006	<b>S</b>
	white RAL 9016	<b>W</b>
<b>8</b>	<b>DEKORRING FARBE</b> DECORATION RING COLOUR BAGUE DÉCORATIVE COULEUR	
	black RAL 9005	<b>B</b>
	silver RAL 9006	<b>S</b>
	white RAL 9016	<b>W</b>
	beaten gold	<b>G</b>
	beaten silver	<b>A</b>
	beaten bronze	<b>C</b>
<b>9</b>	<b>DIFFUSOR</b> DIFFUSER DIFFUSEUR	
	opal	<b>O</b>
	microprism	<b>M</b>
	office special	<b>B</b>

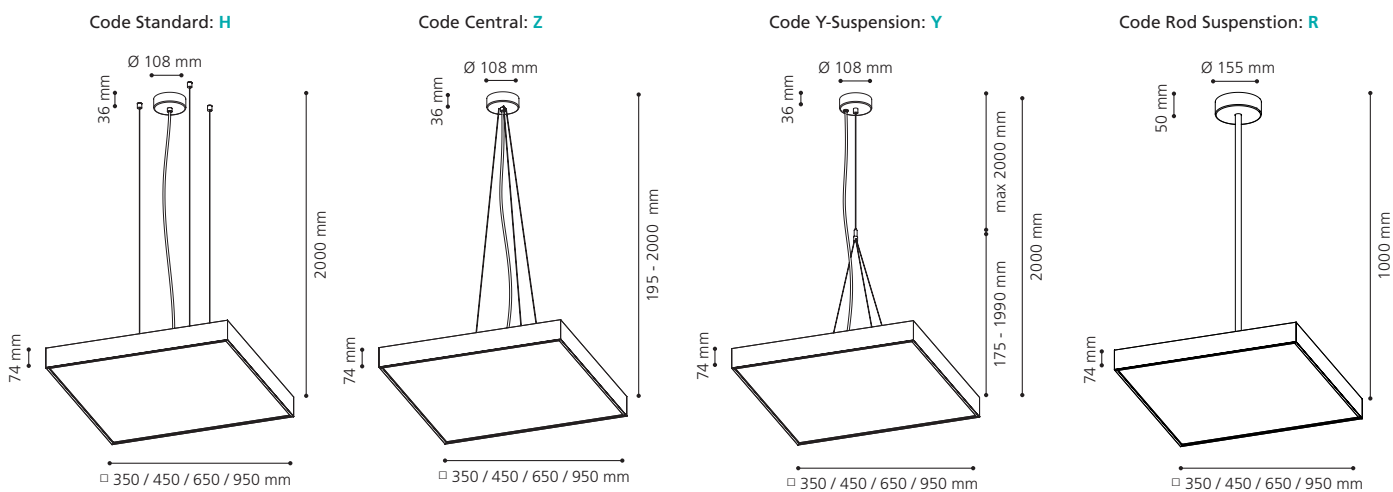

Size [mm]	opal direct		microprism direct		office special direct		opal direct + indirect		microprism direct + indirect		office special direct + indirect		kg
	low output [lm] / [W]	high output [lm] / [W]	low output [lm] / [W]	high output [lm] / [W]	low output [lm] / [W]	high output [lm] / [W]	low output [lm] / [W]	high output [lm] / [W]	low output [lm] / [W]	high output [lm] / [W]	low output [lm] / [W]	high output [lm] / [W]	
□ 350	1.349 / 9,9	2.365 / 16,7	1.256 / 9,9	2.208 / 16,7	1.402 / 9,9	2.470 / 16,7	2.029 / 13,8	3.488 / 23,1	1.923 / 13,8	3.308 / 23,1	2.081 / 13,8	3.579 / 23,1	4,4
□ 450	2.288 / 15,4	4.011 / 25,9	2.130 / 15,4	3.744 / 25,9	2.377 / 15,4	4.189 / 25,9	3.236 / 20,7	5.563 / 34,6	3.067 / 20,7	5.276 / 34,6	3.319 / 20,7	5.709 / 34,6	5,8
□ 650	4.711 / 30,5	8.258 / 51,6	4.385 / 30,5	7.708 / 51,6	4.894 / 30,5	8.624 / 51,6	5.845 / 37,0	10.048 / 61,8	5.845 / 37,0	9.530 / 61,8	5.995 / 37,0	10.312 / 61,8	9,8
□ 950	9.868 / 60,9	17.299 / 102,8	9.187 / 60,9	16.148 / 102,8	10.252 / 60,9	18.067 / 102,8	10.918 / 67,4	18.770 / 112,6	10.348 / 67,4	17.801 / 112,6	11.198 / 67,4	19.262 / 112,6	23,9

Alle Lumenangaben für 4000K, CRI>80, Gehäusefarbe weiß

All lumen values for 4000K, CRI>80, housing colour white

Toutes les données de lumens pour 4000K, CRI>80, couleur du boîtier blanc



# ROPE22

HÄNGELEUCHE | PENDANT LUMINAIRE | LUMINAIRE SUSPENSION

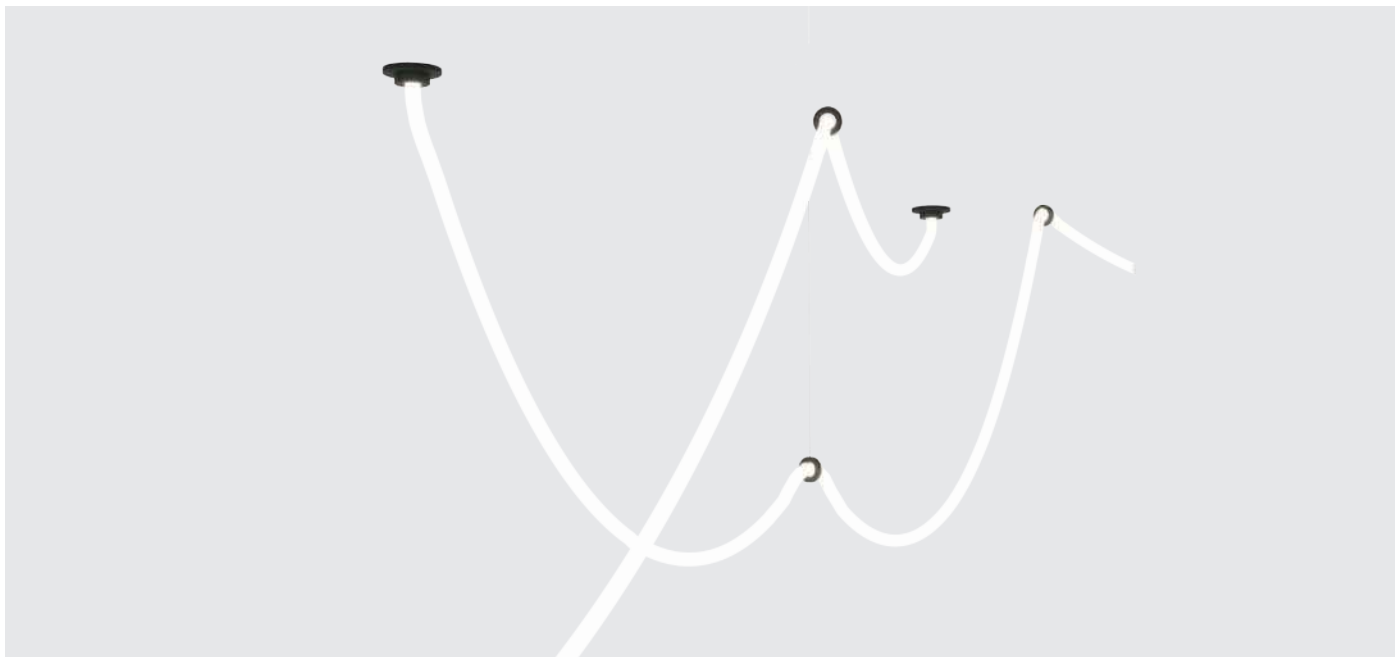

**LED Hängeleuchte** mit 360° Abstrahlcharakteristik. Lichtschlauch aus lebensmittelechtem Silikon mit einem Durchmesser von 22mm. Der Lichtschlauch ist erhältlich in verschiedenen Standardlängen von 1.200mm bis 10.000mm. Die Produktfamilie ROPE22 beinhaltet verschiedenstes Montagezubehör zur Aufbau-, Einbau-, und Pendelmontage. Die Zubehörteile sind in den feinstruktur matt pulverbeschichteten Standardfarben schwarz ähnlich RAL 9005 sowie weiß ähnlich RAL 9016 erhältlich – zusätzlich erhältlich sind alle Teile in eloxierter Variante mit den Standardfarben: gold, anthrazit oder mitternachtsblau. RAL nach Wahl steht Ihnen auf Anfrage zur Verfügung. Sämtliches Pendelzubehör wird mit Seilabhängungen zur stufenlosen Regulierung der Montagehöhe geliefert. Der LED-Treiber ist im Aufbaubaldachin integriert oder als Decken-Einwurf Gerät zum Einbaubaldachin integriert - wahlweise als on/off oder DALI-Variante. Farbtemperaturen 2700K, 3000K oder 4000K – Farbwiedergabe CRI>90 - Mac Adam ≤3. Weitere Steuerungsoptionen oder Lichtfarben auf Anfrage erhältlich.

**Pendant LED luminaire** with 360° beam characteristics. Light tube made of food-grade silicone with a diameter of 22mm. The light tube is available in various standard lengths from 1.200mm to 10.000mm. The ROPE22 product family includes a wide range of mounting accessories for surface, recessed and pendant mounting. The accessories are available in the fine-textured matt powder-coated standard colours black similar to RAL 9005 and similar to white RAL 9016 - all parts are also available in anodised versions with the standard colours: gold, anthracite or midnight blue. RAL colours of your choice are available on request. All pendant accessories are supplied with wire suspensions for infinitely variable adjustment of the mounting height. The LED driver is integrated into the surface-mounted canopy or integrated into the recessed canopy as a throw-in ceiling device - optionally as an on/off or DALI version. Colour temperatures 2700K, 3000K or 4000K - colour rendering CRI>90 - Mac Adam ≤3. Further control options or light colours available on request.

**Luminaire LED suspendu** avec un faisceau de 360°. Tube lumineux en silicone alimentaire d'un diamètre de 22 mm. Le tube lumineux est disponible en différentes longueurs standard de 1.200 mm à 10.000 mm. La famille de produits ROPE22 comprend une large gamme d'accessoires de montage pour les montages en surface, encastrés et suspendus. Les accessoires sont disponibles dans les couleurs standard noir similaire à RAL 9005 et blanc similaire à RAL 9016, avec un revêtement en poudre mat à texture fine. Toutes les pièces sont également disponibles en version anodisée dans les couleurs standard : or, anthracite ou bleu nuit. Les couleurs RAL de votre choix sont disponibles sur demande. Tous les accessoires suspendus sont livrés avec des suspensions en fil de fer permettant un réglage en continu de la hauteur de montage. Le pilote LED est intégré dans le boîtier en saillie ou dans le boîtier encastré en tant qu'élément de plafond à encastrer - au choix en version marchelarrêt ou DALI. Températures de couleur 2700K, 3000K ou 4000K - rendu des couleurs CRI>90 - Mac Adam ≤3. D'autres options de commande ou couleurs de lumière sont disponibles sur demande.

## ÜBERSICHT | OVERVIEW | VUE D'ENSEMBLE

TECHNICAL DATA
2700K / 3000K / 4000K
CRI>90
MacAdam ≤ 3
on-off / DALI
360° light emission
L80 B10 50.000h

--	--	--	--	--	--	--	--	--

RAL colour of your choice	Contact us for more options...

HOUSING COLOUR					
schwarz   black   noir RAL 9005		mitternachtsblau eloxiert   midnight blue anodised   bleu minuit anodisé		gold eloxiert   gold anodised   or anodisé	
weiß   white   blanc RAL 9016		anthrazit eloxiert   anthracite anodised   anthracite anodisé			

# HÄNGELEUCHE „ROPE22“

PENDANT LUMINAIRE “ROPE22”

LUMINAIRE SUSPENSION « ROPE22 »

## ROPE22:

1 LÄNGE LENGTH LONGEUR	
1.200 mm	01
2.500 mm	25
5.000 mm	50
7.500 mm	75
10.000 mm	10

2 FARBTEMPERATUR COLOUR TEMPERATURE TEMPÉRATURE DE COULEUR	
2700K	27
3000K	30
4000K	40

Bestellbeispiel | Example order | Exemple de commande  
10.000 mm, CRI>90, 4000K

**6 RP22C-10940**

1 2

## ROPE electrical accessories:

1 BESCHREIBUNG DESCRIPTION DESCRIPTION	
power supply surface	PA
power supply recessed	PE

2 LEISTUNG & STEUERUNG OUTPUT & CONTROL SORTIE & CONTRÔLE	
on/off	OO
DALI	DD

3 GEHÄUSEFARBE HOUSING COLOUR COULEUR DU BOÎTIER	
white RAL 9016	WH
black RAL 9005	BL
midnight blue anodised	BA
anthracite anodised	AA
gold anodised	GA

Bestellbeispiel | Example order | Exemple de commande  
power supply surface, DALI, black

**6 RP22C-PA-DDBL**

1 2 3

## ROPE mechanical accessories:

1 BESCHREIBUNG DESCRIPTION DESCRIPTION	
mounting-set recessed	IE
mounting-set surface	IA
mounting-ring surface	RA
mounting-ring suspended	RH
endcap	EC
surface-endcap	SC

2 GEHÄUSEFARBE HOUSING COLOUR COULEUR DU BOÎTIER	
white RAL 9016	WH
black RAL 9005	BL
midnight blue anodised	BA
anthracite anodised	AA
gold anodised	GA

Bestellbeispiel | Example order | Exemple de commande  
mounting-ring suspended, black

**6 RP22C-RH-BL**

1 2

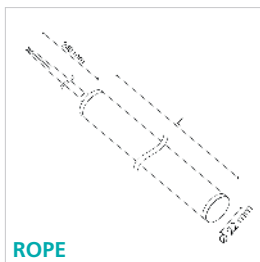

ROPE

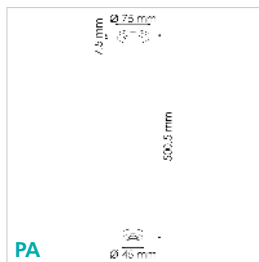

PA

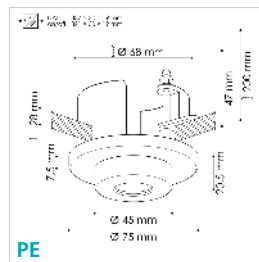

PE

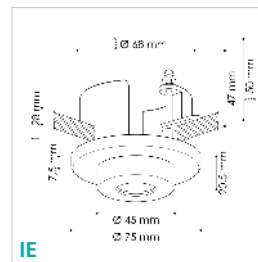

IE

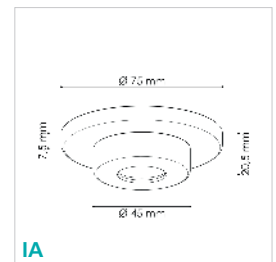

IA

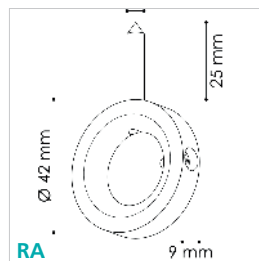
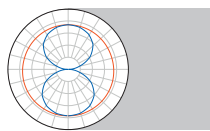

RA

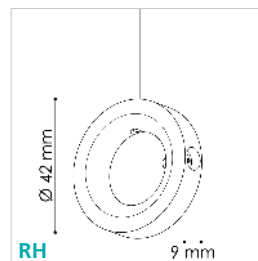

RH

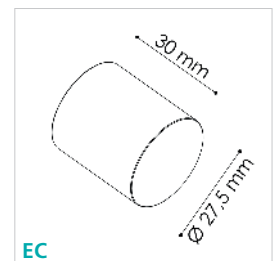

EC

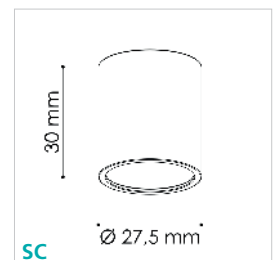

SC

Size [mm]	low output [lm] / [W]	 [kg]
1.200	1.968 / 18,0	0,56
2.500	4.100 / 37,5	1,18
5.000	8.200 / 75,0	2,35
7.500	12.300 / 112,5	3,53
10.000	16.400 / 150,0	4,7

Alle Lumenangaben für 4000K, CRI>90

All lumen values for 4000K, CRI>90

Toutes les données de lumens pour 4000K, CRI>90

# OVERVIEW

WANDLEUCHTEN | WALL LUMINAIRES | *APPLIQUES MURALES*



LINE40  
**182**



LINE50  
**184**



LINE70  
**186**



ROUND90  
**188**



SQUARE90  
**190**

# WANDLEUCHTEN

WALL LUMINAIRES

*APPLIQUES MURALES*

# LINE40

WANDLEUCHTE | WALL LUMINAIRE | APPLIQUE MURALE

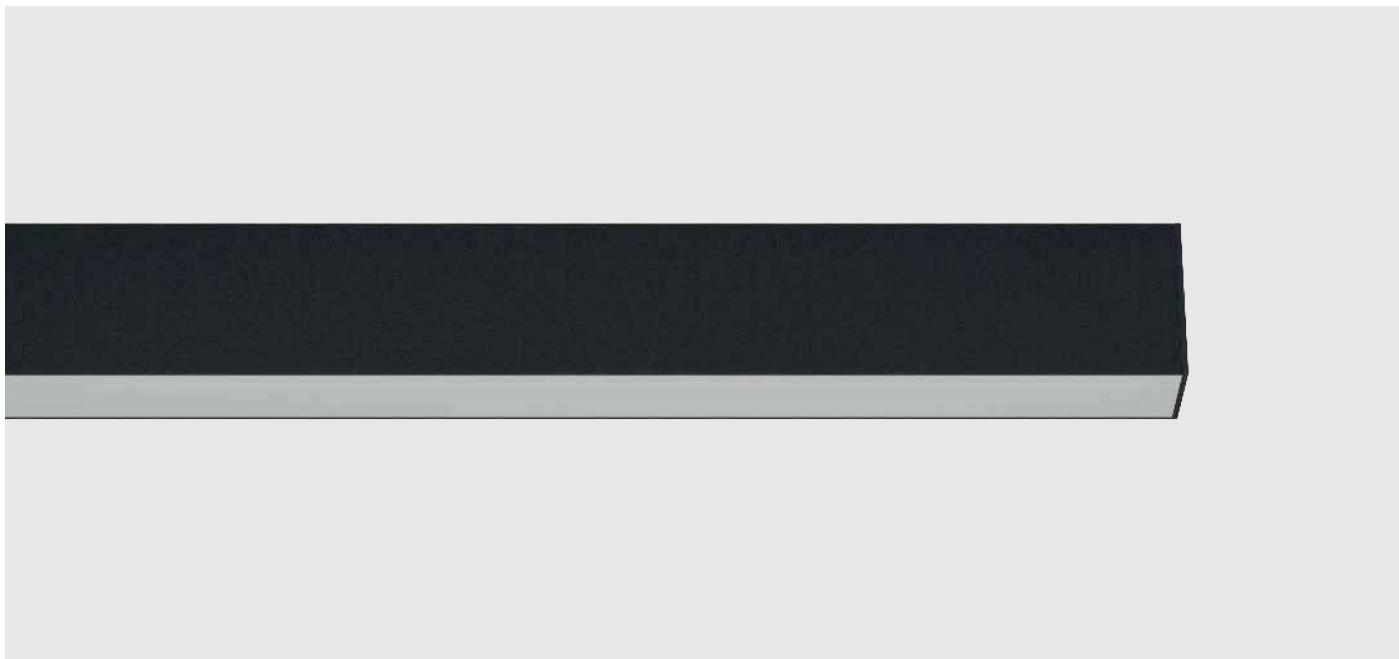

**LED-Wandleuchte** direktstrahlend oder direkt-indirektstrahlend. Lichtkanal aus Aluminium-Strangpressprofil mit einer Breite von 41 mm. Fertigung der Leuchtenlänge millimetergenau auf Kundenwunsch möglich. Oberfläche der Leuchte feinstruktur matt pulverbeschichtet ähnlich RAL 9016 weiß, RAL 9006 silber oder RAL 9005 schwarz – auf Anfrage in RAL nach Wahl. Diffusor wahlweise in PMMA opal oder PMMA klar mit eingeschobener mikroprismatischer Platte für eine reduzierte Leuchtdichte (UGR<19). Leuchte inkl. speziellem schnellmontage-Wandbaldachin (Montage mittels Stecker und Gegenstecker). Der LED-Treiber ist im Leuchtgehäuse integriert – wahlweise als on/off oder DALI-Variante. Farbtemperaturen 2700K, 3000K, 4000K oder dynamisch Weiß (2700K-6500K) – Farbwiedergabe CRI>80 oder CRI>90 – Mac Adam ≤3. Weitere Steuerungsoptionen oder Lichtfarben auf Anfrage erhältlich. Außerdem ist die Integration vieler Komponenten, wie beispielsweise Notlicht oder Sensortechnologie, sowie eine Vielzahl weiterer Optionen möglich.

**Wall-mounted LED luminaire** with direct beam or direct-indirect beam. Light channel made of extruded aluminium profile with a width of 41 mm. Luminaire length can be manufactured to the exact millimetre on customer request. Surface of the luminaire fine structure matt powder coated similar to RAL 9016 white, RAL 9006 silver or RAL 9005 black - on request in RAL of choice. Diffuser either in PMMA opal or PMMA clear with inserted microprismatic plate for reduced luminance (UGR<19). Luminaire incl. special quick-mount wall canopy (mounting with plug and counterplug). The LED driver is integrated in the luminaire housing - either as on/off or DALI version. Colour temperatures 2700K, 3000K, 4000K or dynamic white (2700K-6500K) - colour rendering CRI>80 or CRI>90 - Mac Adam ≤3. Further control options or light colours available on request. In addition, the integration of many components, such as emergency lighting or sensor technology, as well as a variety of other options is possible.

**Luminaire LED mural** à éclairage direct ou direct-indirect. Canal lumineux en profilé d'aluminium extrudé d'une largeur de 41 mm. Fabrication de la longueur du luminaire au millimètre près possible sur demande du client. Surface du luminaire à structure fine, revêtement par poudre mat similaire à RAL 9016 blanc, RAL 9006 argent ou RAL 9005 noir - sur demande en RAL au choix. Diffuseur au choix en PMMA opale ou en PMMA transparent avec plaque microprismatique insérée pour un éblouissement réduit (UGR<19). Luminaire avec A mural spécial à montage rapide (montage au moyen d'une fiche et d'une contre-fiche). Le pilote LED est intégré dans le boîtier du luminaire - au choix sous forme de variante on/off ou DALI. Températures de couleur 2700K, 3000K, 4000K ou blanc dynamique (2700K-6500K) - Rendu des couleurs CRI>80 ou CRI>90 - Mac Adam ≤3. Autres options de commande ou couleurs de lumière disponibles sur demande. En outre, l'intégration de nombreux composants, tels que l'éclairage de secours ou des capteurs, une multitude d'autres options sont possibles.

## ÜBERSICHT | OVERVIEW | VUE D'ENSEMBLE

### TECHNICAL DATA

2700K / 3000K / 4000K / 2700-6500K

CRI>80 / CRI>90

MacAdam ≤ 3

up to 142 lm/W, up to 6.245 lm/m

on-off / DALI

direct / direct + indirect

opal / microprism (UGR <19)

L80 B10 50.000h

### HOUSING COLOUR

schwarz | black | noir  
RAL 9005

silber | silver | argent  
RAL 9006

weiß | white | blanc  
RAL 9016



RAL colour of your choice



Integration of Multisensor



Welded mitre cuts



Integration of emergency light



Contact us for more options...

**WANDLEUCHTE „LINE40“**  
**WALL LUMINAIRE “LINE40”**  
**APPLIQUE MURALE « LINE40 »**

Bestellbeispiel | Example order | Exemple de commande  
 3.132 mm, CRI>90, 4000K, direct + indirect, low output on/off, black, microprism

**LI40W-319402-LOBLM**

1 2 3 4 5 6 7

1 LÄNGE LENGTH LONGEUR	
612 mm	06
972 mm	09
1.212 mm	12
1.452 mm	14
1.692 mm	16
1.932 mm	19
2.172 mm	21
2.412 mm	24
2.892 mm	28
3.132 mm	31
3.854 mm	38

2 FARBWIEDERGABE COLOUR RENDERING RENDU DES COULEURS	
CRI>80	8
CRI>90	9

3 FARBTEMPERATUR COLOUR TEMPERATURE TEMPÉRATURE DE COULEUR	
2700K (CRI>90 only)	27
3000K	30
4000K	40
2700-6500K (CRI>90 only)	DW

4 LICHTVERTEILUNG LIGHT DISTRIBUTION DISTRIBUTION DE LA LUMIÈRE	
direct	1
direct + indirect	2

5 LEISTUNG & STEUERUNG OUTPUT & CONTROL SORTIE & CONTRÔLE	
low output on/off	LO
low output DALI	LD
high output on/off	HO
high output DALI	HD
dynamic white DALI DT8	DW

6 GEHÄUSEFARBE HOUSING COLOUR COULEUR DU BÔITIER	
silver RAL 9006	SI
white RAL 9016	WH
black RAL 9005	BL

7 DIFFUSOR DIFFUSER DIFFUSEUR	
opal	O
microprism	M

direct

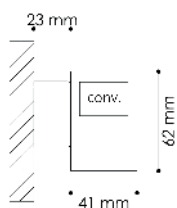

direct + indirect

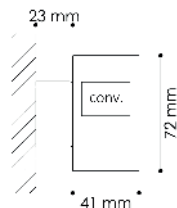

opal direct

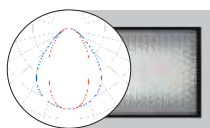

microprism direct

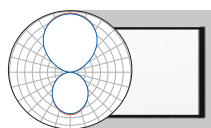

opal direct + indirect

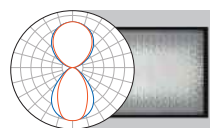

microprism direct + indirect

direct indirect

Size [mm]	opal direct		microprism direct		opal direct + indirect		microprism direct + indirect		direct	indirect
	low output [lm] / [W]	high output [lm] / [W]	low output [lm] / [W]	high output [lm] / [W]	low output [lm] / [W]	high output [lm] / [W]	low output [lm] / [W]	high output [lm] / [W]	kg	kg
612	840 / 8,8	1.495 / 16,3	876 / 8,8	1.560 / 16,3	1.923 / 16,3	3.668 / 30,0	1.962 / 16,3	3.761 / 30,0	1,4	1,7
972	1.324 / 13,0	2.461 / 25,0	1.381 / 13,0	2.567 / 25,0	3.077 / 23,7	5.869 / 46,3	3.139 / 23,7	6.018 / 46,3	2,1	2,8
1.212	1.777 / 16,3	3.150 / 30,0	1.854 / 16,3	3.286 / 30,0	3.845 / 29,1	7.336 / 57,2	3.924 / 29,1	7.522 / 57,2	2,6	3,4
1.452	2.010 / 18,5	3.763 / 35,8	2.097 / 18,5	3.925 / 35,8	4.615 / 34,5	8.803 / 68,1	4.709 / 34,5	9.026 / 68,1	3,2	4,2
1.692	2.398 / 21,2	4.470 / 41,1	2.501 / 21,2	4.663 / 41,1	5.384 / 39,5	10.270 / 80,8	5.494 / 39,5	10.531 / 80,8	3,7	4,8
1.932	2.779 / 23,7	5.222 / 46,3	2.889 / 23,7	5.448 / 46,3	6.154 / 44,6	11.738 / 91,7	6.278 / 44,6	12.035 / 91,7	4,2	5,5
2.172	3.157 / 26,6	5.931 / 52,0	3.293 / 26,6	6.187 / 52,0	6.923 / 50,0	13.205 / 103,0	7.063 / 50,0	13.540 / 103,0	4,7	6,1
2.412	3.441 / 29,2	6.544 / 57,3	3.590 / 29,2	6.826 / 57,3	7.690 / 56,0	14.672 / 113,0	7.848 / 56,0	15.044 / 113,0	5,3	6,8
2.892	3.880 / 34,3	7.570 / 69,6	4.048 / 34,3	7.897 / 69,6	9.230 / 67,0	17.606 / 135,0	9.418 / 67,0	18.053 / 135,0	6,4	8,2
3.132	4.326 / 36,9	8.516 / 75,5	4.513 / 36,9	8.884 / 75,5	9.999 / 72,3	19.074 / 145,3	10.202 / 72,3	19.557 / 145,3	6,8	8,9
3.854	5.558 / 47,4	10.444 / 92,6	5.798 / 47,4	10.896 / 92,6	12.308 / 89,2	23.476 / 183,4	12.556 / 89,2	24.070 / 183,4	8,5	11,1

Alle Lumenangaben für 4000K, CRI>80, Microprisma ohne Opalfolie

All lumen values for 4000K, CRI>80, microprism without opal foil

Toutes les données de lumens pour 4000K, CRI>80, microprisme sans feuille opale



# LINE50

WANDLEUCHTE | WALL LUMINAIRE | APPLIQUE MURALE

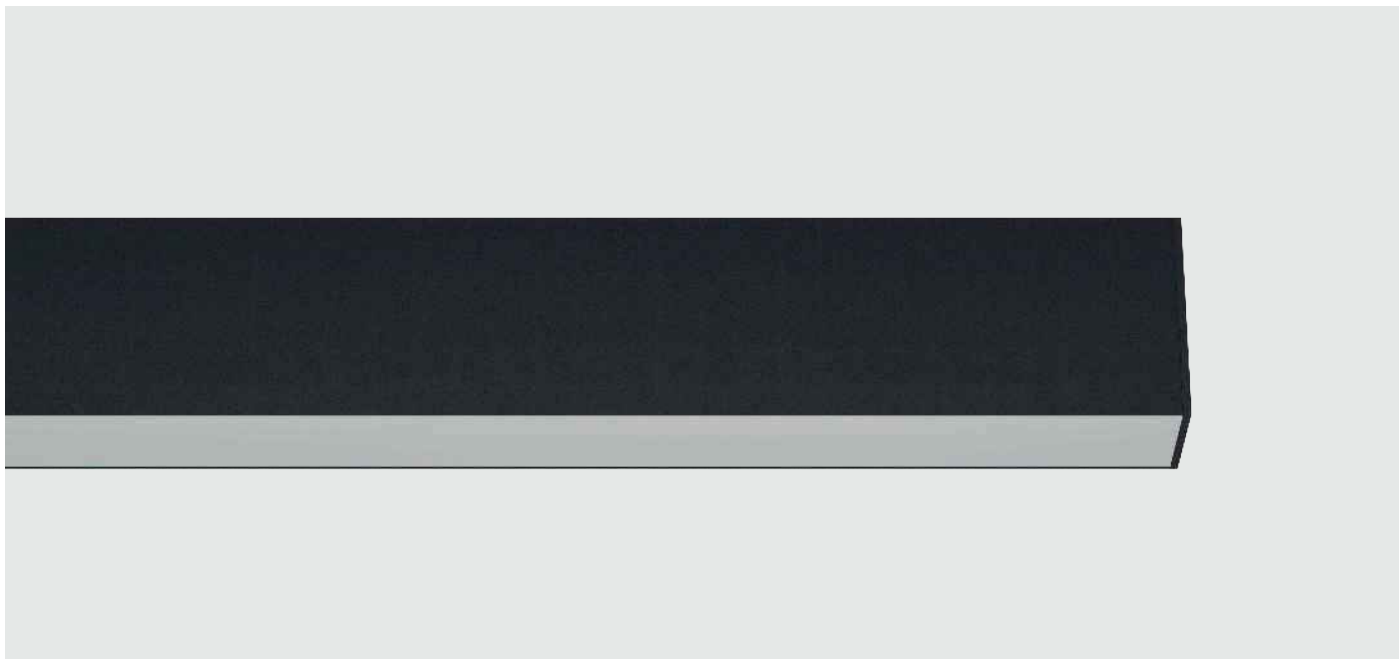

**LED-Wandleuchte** direktstrahlend oder direkt-indirektstrahlend. Lichtkanal aus Aluminium-Strangpressprofil mit einer Breite von 50 mm. Fertigung der Leuchtenlänge millimetergenau auf Kundenwunsch möglich. Oberfläche der Leuchte feinstrukturiert matt pulverbeschichtet ähnlich RAL 9016 weiß, RAL 9006 silber oder RAL 9005 schwarz – auf Anfrage in RAL nach Wahl. Diffusor wahlweise in PMMA opal oder PMMA klar mit eingeschobener mikroprismatischer Platte für eine reduzierte Leuchtdichte (UGR<19). Leuchte inkl. speziellem schnellmontage-Wandbaldachin (Montage mittels Stecker und Gegenstecker). Der LED-Treiber ist im Leuchtengehäuse integriert – wahlweise als on/off oder DALI-Variante. Farbtemperaturen 2700K, 3000K, 4000K oder dynamisch Weiß (2700K–6500K) – Farbwiedergabe CRI>80 oder CRI>90 – Mac Adam ≤3. Weitere Steuerungsoptionen oder Lichtfarben auf Anfrage erhältlich. Außerdem ist die Integration vieler Komponenten, wie beispielsweise Notlicht oder Sensortechnologie, sowie eine Vielzahl weiterer Optionen möglich.

**Wall-mounted LED luminaire** with direct beam or direct-indirect beam. Light channel made of extruded aluminium profile with a width of 50 mm. Luminaire length can be manufactured to the exact millimetre on customer request. Surface of the luminaire fine structure matt powder coated similar to RAL 9016 white, RAL 9006 silver or RAL 9005 black – on request in RAL of choice. Diffuser either in PMMA opal or PMMA clear with inserted microprismatic plate for reduced luminance (UGR<19). Luminaire incl. special quick-mount wall canopy (mounting with plug and counterplug). The LED driver is integrated in the luminaire housing - either as on/off or DALI version. Colour temperatures 2700K, 3000K, 4000K or dynamic white (2700K-6500K) - colour rendering CRI>80 or CRI>90 - Mac Adam ≤3. Further control options or light colours available on request. In addition, the integration of many components, such as emergency lighting or sensor technology, as well as a variety of other options is possible.

**Luminaire LED mural** à éclairage direct ou direct-indirect. Canal lumineux en profilé d'aluminium extrudé d'une largeur de 50 mm. Fabrication de la longueur du luminaire au millimètre près possible sur demande du client. Surface du luminaire à structure fine, revêtement par poudre mat similaire à RAL 9016 blanc, RAL 9006 argent ou RAL 9005 noir - sur demande en RAL au choix. Diffuseur au choix en PMMA opale ou en PMMA transparent avec plaque microprismatique insérée pour un éblouissement réduit (UGR<19). Luminaire mural spécial à montage rapide (montage au moyen d'une fiche et d'une contre-fiche). Le pilote LED est intégré dans le boîtier du luminaire - au choix sous forme de variante on/off ou DALI. Températures de couleur 2700K, 3000K, 4000K ou blanc dynamique (2700K-6500K) - Rendu des couleurs CRI>80 ou CRI>90 - Mac Adam ≤3. Autres options de commande ou couleurs de lumière disponibles sur demande. En outre, l'intégration de nombreux composants, tels que l'éclairage de secours ou la technologie de détection, une multitude d'autres options sont possibles.

## ÜBERSICHT | OVERVIEW | VUE D'ENSEMBLE

### TECHNICAL DATA

2700K / 3000K / 4000K / 2700-6500K

CRI>80 / CRI>90

MacAdam ≤ 3

up to 149 lm/W, up to 6.554 lm/m

on-off / DALI

direct / direct + indirect

opal / microprism (UGR <19)

L80 B10 50.000h

### HOUSING COLOUR

schwarz | black | noir  
RAL 9005

silber | silver | argent  
RAL 9006

weiß | white | blanc  
RAL 9016



RAL colour of your choice



Integration of 3-phase-track



Integration of Multisensor



Welded mitre cuts



Integration of emergency light



Integration of GLOWmini/  
GLOWsmall series



Contact us for more options...

**WANDLEUCHTE „LINE50“**  
**WALL LUMINAIRE “LINE50”**  
**APPLIQUE MURALE « LINE50 »**

Bestellbeispiel | Example order | Exemple de commande  
 3.134 mm, CRI>90, 4000K, direct + indirect, low output on/off, black, microprism

**LI50W-319402-LOBLM**

1 2 3 4 5 6 7

<b>1 LÄNGE</b> LENGTH LONGEUR	
614 mm	<b>06</b>
974 mm	<b>09</b>
1.214 mm	<b>12</b>
1.454 mm	<b>14</b>
1.694 mm	<b>16</b>
1.934 mm	<b>19</b>
2.174 mm	<b>21</b>
2.414 mm	<b>24</b>
2.894 mm	<b>28</b>
3.134 mm	<b>31</b>
3.856 mm	<b>38</b>

<b>2 FARBWIEDERGABE</b> COLOUR RENDERING RENDU DES COULEURS	
CRI>80	<b>8</b>
CRI>90	<b>9</b>

<b>3 FARBTEMPERATUR</b> COLOUR TEMPERATURE TEMPÉRATURE DE COULEUR	
2700K (CRI>90 only)	<b>27</b>
3000K	<b>30</b>
4000K	<b>40</b>
2700-6500K (CRI>90 only)	<b>DW</b>

<b>4 LICHTVERTEILUNG</b> LIGHT DISTRIBUTION DISTRIBUTION DE LA LUMIÈRE	
direct	<b>1</b>
direct + indirect	<b>2</b>

<b>5 LEISTUNG &amp; STEUERUNG</b> OUTPUT & CONTROL SORTIE & CONTRÔLE	
low output on/off	<b>LO</b>
low output DALI	<b>LD</b>
high output on/off	<b>HO</b>
high output DALI	<b>HD</b>
dynamic white DALI DT8	<b>DW</b>

<b>6 GEHÄUSEFARBE</b> HOUSING COLOUR COULEUR DU BOÎTIER	
silver RAL 9006	<b>SI</b>
white RAL 9016	<b>WH</b>
black RAL 9005	<b>BL</b>

<b>7 DIFFUSOR</b> DIFFUSER DIFFUSEUR	
opal	<b>O</b>
microprism	<b>M</b>

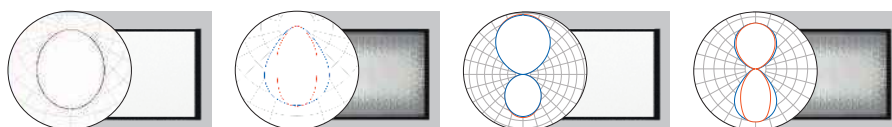
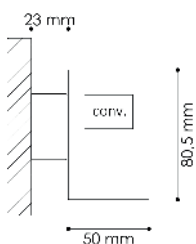

Size [mm]	opal direct		microprism direct		opal direct + indirect		microprism direct + indirect		direct	direct + indirect
	low output [lm] / [W]	high output [lm] / [W]	low output [lm] / [W]	high output [lm] / [W]	low output [lm] / [W]	high output [lm] / [W]	low output [lm] / [W]	high output [lm] / [W]	kg	kg
614	909 / 8,8	1.731 / 16,3	826 / 8,8	1.581 / 16,3	2.060 / 16,3	3.949 / 30,0	1.923 / 16,3	3.668 / 30,0	1,5	1,8
974	1.455 / 13,0	2.770 / 25,0	1.321 / 13,0	2.530 / 25,0	3.296 / 23,7	6.319 / 46,3	3.077 / 23,7	5.869 / 46,3	2,3	3,0
1.214	1.818 / 16,3	3.463 / 30,0	1.652 / 16,3	3.162 / 30,0	4.120 / 29,1	7.898 / 57,2	3.845 / 29,1	7.336 / 57,2	2,9	3,6
1.454	2.182 / 18,5	4.156 / 35,8	1.982 / 18,5	3.794 / 35,8	4.944 / 34,5	9.477 / 68,1	4.615 / 34,5	8.803 / 68,1	3,5	4,4
1.694	2.546 / 21,2	4.848 / 41,1	2.313 / 21,2	4.427 / 41,1	5.769 / 39,5	11.057 / 80,8	5.384 / 39,5	10.270 / 80,8	4,1	5,1
1.934	2.911 / 23,7	5.541 / 46,3	2.642 / 23,7	5.059 / 46,3	6.592 / 44,6	12.636 / 91,7	6.154 / 44,6	11.738 / 91,7	4,6	5,8
2.174	3.273 / 26,6	6.233 / 52,0	2.974 / 26,6	5.692 / 52,0	7.416 / 49,9	14.217 / 103,0	6.923 / 49,9	13.205 / 103,0	5,2	6,5
2.414	3.635 / 29,2	6.926 / 57,3	3.304 / 29,2	6.324 / 57,3	8.240 / 56,0	15.796 / 113,1	7.690 / 56,0	14.672 / 113,1	5,8	7,2
2.894	4.364 / 34,3	8.311 / 69,6	3.964 / 34,3	7.589 / 69,6	9.889 / 67,0	18.955 / 134,8	9.230 / 67,0	17.606 / 134,8	7,0	8,7
3.134	4.728 / 36,9	9.004 / 75,5	4.295 / 36,9	8.221 / 75,5	10.712 / 72,0	20.534 / 145,3	9.999 / 72,3	19.074 / 145,3	7,5	9,4
3.856	5.821 / 47,4	11.082 / 92,6	5.284 / 47,4	10.118 / 92,6	13.183 / 89,0	25.273 / 183,4	12.308 / 89,2	23.476 / 183,4	9,3	11,7

Alle Lumenangaben für 4000K, CRI>80, Microprisma ohne Opalfolie  
 All lumen values for 4000K, CRI>80, microprism without opal foil  
 Toutes les données de lumens pour 4000K, CRI>80, microprisme sans feuille opale

# LINE70

WANDLEUCHTE | WALL LUMINAIRE | APPLIQUE MURALE

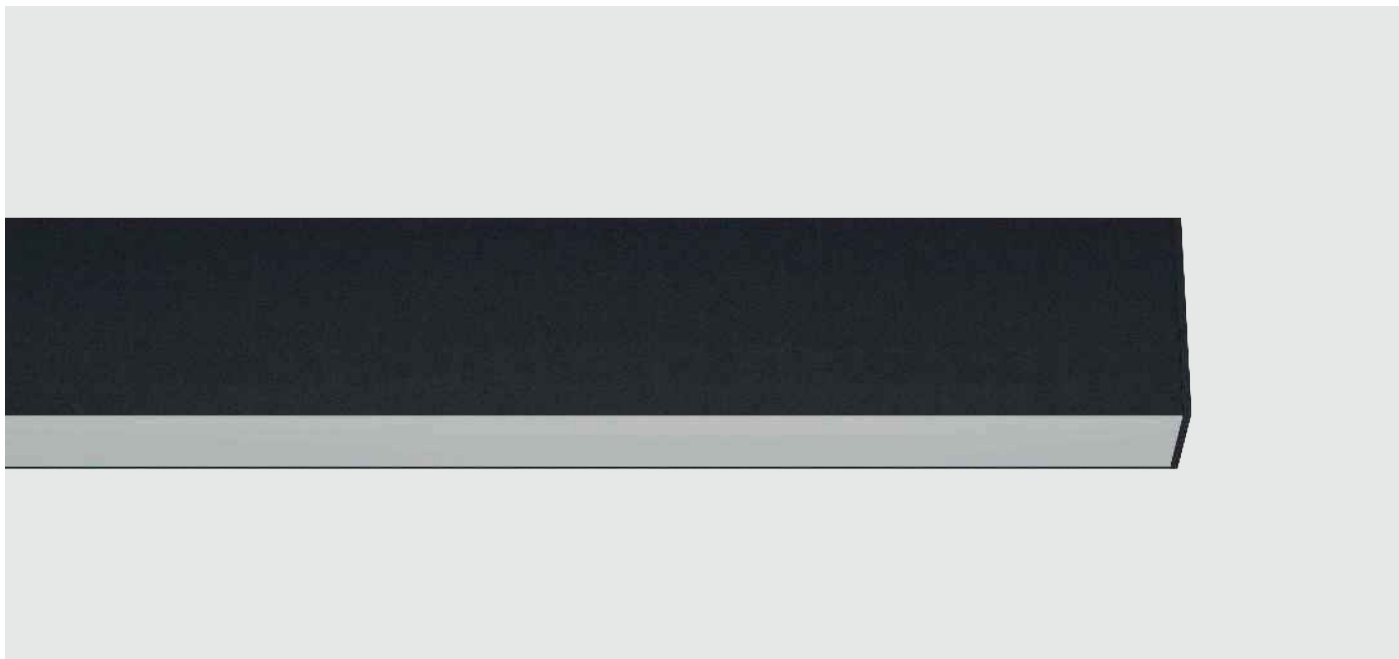

**LED-Wandleuchte** direktstrahlend oder direkt-indirektstrahlend. Lichtkanal aus Aluminium-Strangpressprofil mit einer Breite von 71 mm. Fertigung der Leuchtenlänge millimetergenau auf Kundenwunsch möglich. Oberfläche der Leuchte feinstrukturiert matt pulverbeschichtet ähnlich RAL 9016 weiß, RAL 9006 silber oder RAL 9005 schwarz – auf Anfrage in RAL nach Wahl. Diffusor wahlweise in PMMA opal oder PMMA klar mit eingeschobener mikroprismatischer Platte für eine reduzierte Leuchtdichte (UGR<19). Leuchte inkl. speziellem schnellmontage-Wandbaldachin (Montage mittels Stecker und Gegenstecker). Der LED-Treiber ist im Leuchtengehäuse integriert – wahlweise als on/off oder DALI-Variante. Farbtemperaturen 2700K, 3000K, 4000K oder dynamisch Weiß (2700K–6500K) – Farbwiedergabe CRI>80 oder CRI>90 – Mac Adam ≤3. Weitere Steuerungsoptionen oder Lichtfarben auf Anfrage erhältlich. Außerdem ist die Integration vieler Komponenten, wie beispielsweise Notlicht oder Sensortechnologie, sowie eine Vielzahl weiterer Optionen möglich.

**Wall-mounted LED luminaire** with direct beam or direct-indirect beam. Light channel made of extruded aluminium profile with a width of 71 mm. Luminaire length can be manufactured to the exact millimetre on customer request. Surface of the luminaire fine structure matt powder coated similar to RAL 9016 white, RAL 9006 silver or RAL 9005 black – on request in RAL of choice. Diffuser either in PMMA opal or PMMA clear with inserted microprismatic plate for reduced luminance (UGR<19). Luminaire incl. special quick-mount wall canopy (mounting with plug and counterplug). The LED driver is integrated in the luminaire housing - either as on/off or DALI version. Colour temperatures 2700K, 3000K, 4000K or dynamic white (2700K-6500K) - colour rendering CRI>80 or CRI>90 - Mac Adam ≤3. Further control options or light colours available on request. In addition, the integration of many components, such as emergency lighting or sensor technology, as well as a variety of other options is possible.

**Luminaire LED mural à éclairage** direct ou direct-indirect. Canal lumineux en profilé d'aluminium extrudé d'une largeur de 71 mm. Possibilité de fabriquer la longueur du luminaire au millimètre près sur demande du client. Surface du luminaire à structure fine, revêtement par poudre mat similaire à RAL 9016 blanc, RAL 9006 argent ou RAL 9005 noir - sur demande en RAL au choix. Diffuseur au choix en PMMA opale ou en PMMA transparent avec plaque microprismatique insérée pour un éblouissement réduit (UGR<19). Luminaire mural spécial à montage rapide (montage au moyen d'une fiche et d'une contre-fiche). Le pilote LED est intégré dans le boîtier du luminaire - au choix sous forme de variante on/off ou DALI. Températures de couleur 2700K, 3000K, 4000K ou blanc dynamique (2700K-6500K) - Rendu des couleurs CRI>80 ou CRI>90 - Mac Adam ≤3. Autres options de commande ou couleurs de lumière disponibles sur demande. En outre, l'intégration de nombreux composants, tels que l'éclairage de secours ou la technologie de détection, une multitude d'autres options sont possibles.

## ÜBERSICHT | OVERVIEW | VUE D'ENSEMBLE

### TECHNICAL DATA

2700K / 3000K / 4000K / 2700-6500K

CRI>80 / CRI>90

MacAdam ≤ 3

up to 161 lm/W, up to 6.958 lm/m

on-off / DALI

direct / direct + indirect

opal / microprism (UGR <19)

L80 B10 50.000h

### HOUSING COLOUR

schwarz | black | noir  
RAL 9005

silber | silver | argent  
RAL 9006

weiß | white | blanc  
RAL 9016



RAL colour of your choice



Integration of Multisensor



Welded mitre cuts



Integration of emergency light



Contact us for more options...

**WANDLEUCHTE „LINE70“**  
**WALL LUMINAIRE “LINE70”**  
**APPLIQUE MURALE « LINE70 »**

Bestellbeispiel | Example order | Exemple de commande  
 3.134 mm, CRI>90, 4000K, direct + indirect, low Output on/off, black, microprism

**LI70W-319402-LOBLM**

1 2 3 4 5 6 7

1 LÄNGE LENGTH LONGEUR	
614 mm	06
974 mm	09
1.214 mm	12
1.454 mm	14
1.694 mm	16
1.934 mm	19
2.174 mm	21
2.414 mm	24
2.894 mm	28
3.134 mm	31
3.856 mm	38

2 FARBWIEDERGABE COLOUR RENDERING RENDU DES COULEURS	
CRI>80	8
CRI>90	9

3 FARBTEMPERATUR COLOUR TEMPERATURE TEMPÉRATURE DE COULEUR	
2700K (CRI>90 only)	27
3000K	30
4000K	40
2700-6500K (CRI>90 only)	DW

4 LICHTVERTEILUNG LIGHT DISTRIBUTION DISTRIBUTION DE LA LUMIÈRE	
direct	1
direct + indirect	2

5 LEISTUNG & STEUERUNG OUTPUT & CONTROL SORTIE & CONTRÔLE	
low output on/off	LO
low output DALI	LD
high output on/off	HO
high output DALI	HD
dynamic white DALI DT8	DW

6 GEHÄUSEFARBE HOUSING COLOUR COULEUR DU BOÎTIER	
silver RAL 9006	SI
white RAL 9016	WH
black RAL 9005	BL

7 DIFFUSOR DIFFUSER DIFFUSEUR	
opal	O
microprism	M

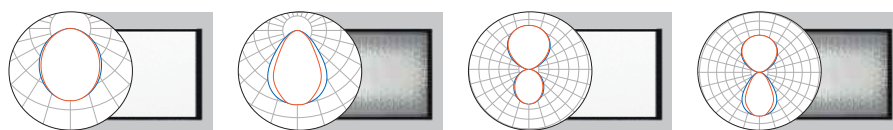
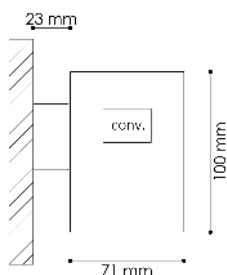

Size [mm]	opal direct		microprism direct		opal direct + indirect		microprism direct + indirect		direct	direct + indirect
	low output [lm] / [W]	high output [lm] / [W]	low output [lm] / [W]	high output [lm] / [W]	low output [lm] / [W]	high output [lm] / [W]	low output [lm] / [W]	high output [lm] / [W]	KG	KG
614	1.077 / 11,8	1.709 / 16,3	1.045 / 11,8	1.608 / 16,3	2.568 / 18,8	4.088 / 30,0	2.536 / 18,8	3.987 / 30	2,8	2,8
974	1.723 / 15,2	2.734 / 25,0	1.672 / 15,2	2.573 / 25,0	4.109 / 28,7	6.541 / 46,3	4.058 / 28,7	6.379 / 46,3	3,8	3,9
1.214	2.154 / 18,8	3.418 / 30,0	2.090 / 18,8	3.216 / 30,0	5.136 / 35,4	8.176 / 57,2	5.072 / 35,4	7.974 / 57,2	4,3	4,4
1.454	2.585 / 22,1	4.102 / 35,8	2.508 / 22,1	3.859 / 35,8	6.163 / 41,6	9.811 / 68,1	6.086 / 41,6	9.569 / 68,1	4,9	5,1
1.694	3.016 / 25,5	4.785 / 41,1	2.926 / 25,5	4.502 / 41,1	7.190 / 47,9	11.446 / 80,8	7.100 / 47,9	11.164 / 80,8	5,5	5,7
1.934	3.446 / 28,7	5.469 / 46,3	3.344 / 28,7	5.146 / 46,3	8.218 / 54,5	13.082 / 91,7	8.116 / 54,5	12.758 / 91,7	6,1	6,3
2.174	3.877 / 32,0	6.152 / 52,0	3.762 / 32,0	5.789 / 52,0	9.245 / 60,8	14.717 / 103,0	9.130 / 60,8	14.353 / 103,0	6,7	7,0
2.414	4.308 / 35,4	6.836 / 57,3	4.180 / 35,4	6.432 / 57,3	10.272 / 65,4	16.352 / 113,1	10.144 / 65,4	15.948 / 113,1	7,5	7,7
2.894	5.170 / 41,6	8.203 / 69,6	5.016 / 41,6	7.718 / 69,6	12.326 / 77,4	19.622 / 134,8	12.172 / 77,4	19.138 / 134,8	8,9	9,2
3.134	5.600 / 44,8	8.887 / 75,5	5.434 / 44,8	8.362 / 75,5	13.354 / 83,4	21.258 / 145,3	13.189 / 83,4	20.732 / 145,3	9,5	9,9
3.856	6.892 / 57,4	10.938 / 92,6	6.688 / 57,4	10.292 / 92,6	16.436 / 109	26.164 / 183,4	16.232 / 109	25.516 / 183,4	11,7	12,1

Alle Lumenangaben für 4000K, CRI>80, Microprisma ohne Opalfolie  
 All lumen values for 4000K, CRI>80, microprism without opal foil  
 Toutes les données de lumens pour 4000K, CRI>80, microprisme sans feuille opale

# ROUND90

WANDLEUCHE | WALL LUMINAIRE | APPLIQUE MURALE

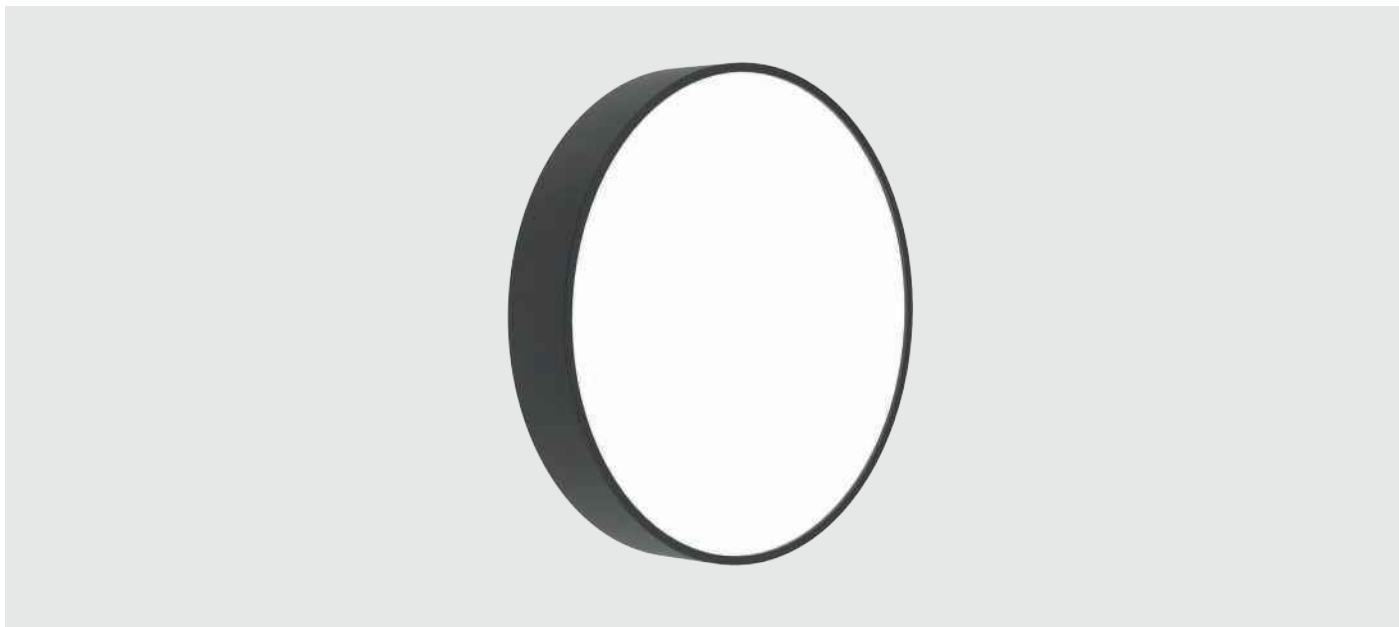

**Runde LED-Flächenleuchte zur Wandmontage.** Direktstrahlend oder direkt-indirektstrahlend. Gehäuse aus gerolltem Aluminiumprofil, nahtlos verschweißt. Fertigung der Leuchte in vier Durchmesser: 350, 450, 650 und 950 mm mit einer Gesamthöhe von 90 mm. Oberfläche pulverbeschichtet feinstruktur matt ähnlich RAL 9016 weiß, RAL 9006 silber oder RAL 9005 schwarz – auf Anfrage in RAL nach Wahl. Die durchdachte Konstruktion der Leuchte ermöglicht ein Design in zahlreichen Farbkombinationen – zwischen Gehäusefarbe und Dekorring kann beliebig kombiniert werden. Um der Leuchtenfamilie neben den Standardfarben einen dekorativen Touch zu verleihen, steht der Dekorring auch in den strukturierten Spezialoberflächen schlaggold, schlagsilber und schlagbronze zur Auswahl. Diffusor in PMMA wahlweise opal, mikroprismatisch inkl. Streufolie oder nur mikroprismatisch (office special) für eine reduzierte Leuchtdichte (UGR<19). Einfache Montage durch Einschieben des Leuchtgehäuses in den Baldachin. Der LED-Treiber ist im Leuchtgehäuse integriert – wahlweise als on/off oder DALI-Variante. Farbtemperaturen 2700K, 3000K, 4000K oder dynamisch Weiß (2700K–6500K) – Farbwiedergabe CRI>80 oder CRI>90 – Mac Adam ≤3. Weitere Steuerungsoptionen oder Lichtfarben auf Anfrage möglich. Außerdem ist die Integration vieler Komponenten, wie beispielsweise Notlicht oder Sensortechnologie, sowie eine Vielzahl weiterer Optionen möglich.

**Round wall-mounted LED luminaire.** Direct beam or direct-indirect beam. Housing made of rolled aluminium profile, seamlessly welded. Luminaire manufactured in four diameters: 350, 450, 650 and 950 mm with a total height of 90 mm. Surface powder coated fine structure matt similar to RAL 9016 white, RAL 9006 silver or RAL 9005 black - on request in RAL of choice. The sophisticated construction of the luminaire allows a design in numerous colour combinations - any combination of housing colour and decorative ring is also available in the special textured surfaces beaten gold, beaten silver and beaten bronze. Diffuser in PMMA either opal, microprism incl. diffuser foil or only microprism (office special) for reduced luminance (UGR<19). Easy installation by sliding the luminaire housing into the canopy. The LED driver is integrated in the luminaire housing - either as on/off or DALI version. Colour temperatures 2700K, 3000K, 4000K or dynamic white (2700K-6500K) - colour rendering CRI>80 or CRI>90 - Mac Adam ≤3. Further control options or light colours available on request. In addition, the integration of many components, such as emergency lighting or sensor technology, as well as a variety of other options is possible.

**Luminaire LED rond pour montage mural.** Éclairage direct ou éclairage direct-indirect. Boîtier en profilé d'aluminium roulé, soudé sans soudure. Fabrication du luminaire en quatre diamètres : 350, 450, 650 et 950 mm avec une hauteur totale de 90 mm. Surface revêtue par poudre à structure fine mate similaire à RAL 9016 blanc, RAL 9006 argent ou RAL 9005 noir - sur demande en RAL au choix. La construction bien pensée du luminaire permet un design dans de nombreuses combinaisons de couleurs - il est possible de combiner à volonté entre la couleur du boîtier et l'anneau décoratif. Pour donner à la famille de luminaires une touche décorative en plus des couleurs standard, l'anneau décoratif est également disponible dans les surfaces spéciales structurées or choc, argent choc et bronze choc. Diffuseur en PMMA au choix opale, microprismatique y compris feuille diffusante ou uniquement microprismatique (office special) pour un éblouissement réduit (UGR<19). Montage facile en insérant le corps du luminaire dans le canopy. Le driver LED est intégré dans le boîtier du luminaire - au choix en version on/off ou DALI. Températures de couleur 2700K, 3000K, 4000K ou blanc dynamique (2700K-6500K) - Rendu des couleurs CRI>80 ou CRI>90 - Mac Adam ≤3. Autres options de commande ou couleurs de lumière possibles sur demande. En outre, l'intégration de nombreux composants, tels que l'éclairage de secours ou la technologie des capteurs, une multitude d'autres options sont possibles.

## ÜBERSICHT | OVERVIEW | VUE D'ENSEMBLE

TECHNICAL DATA	
2700K / 3000K / 4000K / 2700-6500K	
CRI>80 / CRI>90	
MacAdam ≤ 3	
up to 174 lm/W	
on-off / DALI	
direct / direct + indirect	
opal / microprism / office special (UGR <19)	
L80 B10 50.000h	
HOUSING COLOUR	
schwarz   black   noir RAL 9005	
silber   silver   argent RAL 9006	
weiß   white   blanc RAL 9016	

RAL colour of your choice	Integration of Multisensor	Integration of emergency light	Contact us for more options...					
DECORATION RING COLOUR								
schwarz   black   noir RAL 9005		schlaggold   beaten gold   or texturés						
silber   silver   argent RAL 9006		schlagsilber   beaten silver   argent texturés						
weiß   white   blanc RAL 9016		schlagbronze   beaten bronze   bronze texturés						

**WANDLEUCHTE „ROUND90“**  
**WALL LUMINAIRE "ROUND90"**  
**APPLIQUE MURALE « ROUND90 »**

Bestellbeispiel | Example order | Exemple de commande  
 350 mm, CRI>90, 4000K, direct, low output on/off, black, beaten gold, microprism

**RO90W-359401-LOBGM**

1 2 3 4 5 6 7 8

<b>1</b>	<b>DURCHMESSER</b> DIAMETER DIAMÈTRE	
	350 mm	<b>35</b>
	450 mm	<b>45</b>
	650 mm	<b>65</b>
	950 mm	<b>95</b>
<b>2</b>	<b>FARBWIEDERGABE</b> COLOUR RENDERING RENDU DES COULEURS	
	CRI>80	<b>8</b>
	CRI>90	<b>9</b>
<b>3</b>	<b>FARBTEMPERATUR</b> COLOUR TEMPERATURE TEMPÉRATURE DE COULEUR	
	2700K (CRI>90 only)	<b>27</b>
	3000K	<b>30</b>
	4000K	<b>40</b>
	2700-6500K (CRI>90 only)	<b>DW</b>

<b>4</b>	<b>LICHTVERTEILUNG</b> LIGHT DISTRIBUTION DISTRIBUTION DE LA LUMIÈRE	
	direct	<b>1</b>
	direct + indirect	<b>2</b>
<b>5</b>	<b>LEISTUNG &amp; STEUERUNG</b> OUTPUT & CONTROL SORTIE & CONTRÔLE	
	low output on/off	<b>LO</b>
	low output DALI	<b>LD</b>
	high output on/off	<b>HO</b>
	high output DALI	<b>HD</b>
	dynamic white DALI DT8	<b>DW</b>
<b>6</b>	<b>GEHÄUSEFARBE</b> HOUSING COLOUR COULEUR DU BOÎTIER	
	black RAL 9005	<b>B</b>
	silver RAL 9006	<b>S</b>
	white RAL 9016	<b>W</b>

<b>7</b>	<b>DEKORRING FARBE</b> DECORATION RING COLOUR BAGUE DÉCORATIVE COULEUR	
	black RAL 9005	<b>B</b>
	silver RAL 9006	<b>S</b>
	white RAL 9016	<b>W</b>
	beaten gold	<b>G</b>
	beaten silver	<b>A</b>
	beaten bronze	<b>C</b>
<b>8</b>	<b>DIFFUSOR</b> DIFFUSER DIFFUSEUR	
	opal	<b>O</b>
	microprism	<b>M</b>
	office special	<b>B</b>

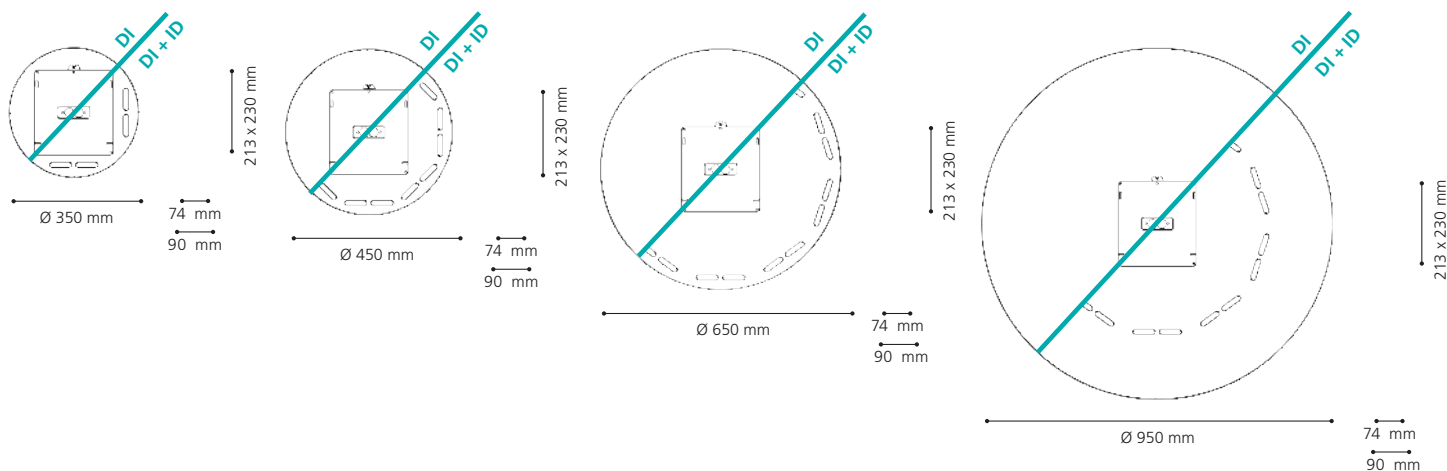

Size [mm]	opal direct		microprism direct		office special direct		opal direct + indirect		microprism direct + indirect		office special direct + indirect		KG
	low output [lm] / [W]	high output [lm] / [W]	low output [lm] / [W]	high output [lm] / [W]	low output [lm] / [W]	high output [lm] / [W]	low output [lm] / [W]	high output [lm] / [W]	low output [lm] / [W]	high output [lm] / [W]	low output [lm] / [W]	high output [lm] / [W]	
Ø 350	1.158 / 8,5	1.826 / 12,9	1.077 / 8,5	1.697 / 12,9	1.213 / 8,5	1.905 / 12,9	1.747 / 11,9	2.625 / 17,5	1.661 / 11,9	2.493 / 17,5	1.795 / 11,9	2.691 / 17,5	3,4
Ø 450	2.258 / 15,5	3.561 / 23,5	2.099 / 15,5	3.309 / 23,5	2.364 / 15,5	3.715 / 23,5	3.207 / 20,7	4.820 / 30,3	3.050 / 20,7	4.577 / 30,2	3.296 / 20,7	4.942 / 30,3	4,0
Ø 650	4.114 / 27,2	6.489 / 41,3	3.825 / 27,2	6.029 / 41,3	4.309 / 27,2	6.770 / 41,3	5.534 / 35,2	8.317 / 51,3	5.263 / 35,2	7.897 / 51,3	5.687 / 35,2	8.526 / 51,3	7,6
Ø 950	9.102 / 56,7	14.360 / 86,0	8.466 / 56,7	13.342 / 86,0	9.535 / 56,7	14.982 / 86,0	11.036 / 67,7	16.585 / 99,1	10.494 / 67,7	15.748 / 99,1	11.342 / 67,7	17.004 / 99,1	19,0

Alle Lumenangaben für 4000K, CRI>80, Gehäusefarbe weiß  
 All lumen values for 4000K, CRI>80, housing colour white  
 Toutes les données de lumens pour 4000K, CRI>80, couleur du boîtier blanc



# SQUARE90

WANDLEUCHTE | WALL LUMINAIRE | APPLIQUE MURALE

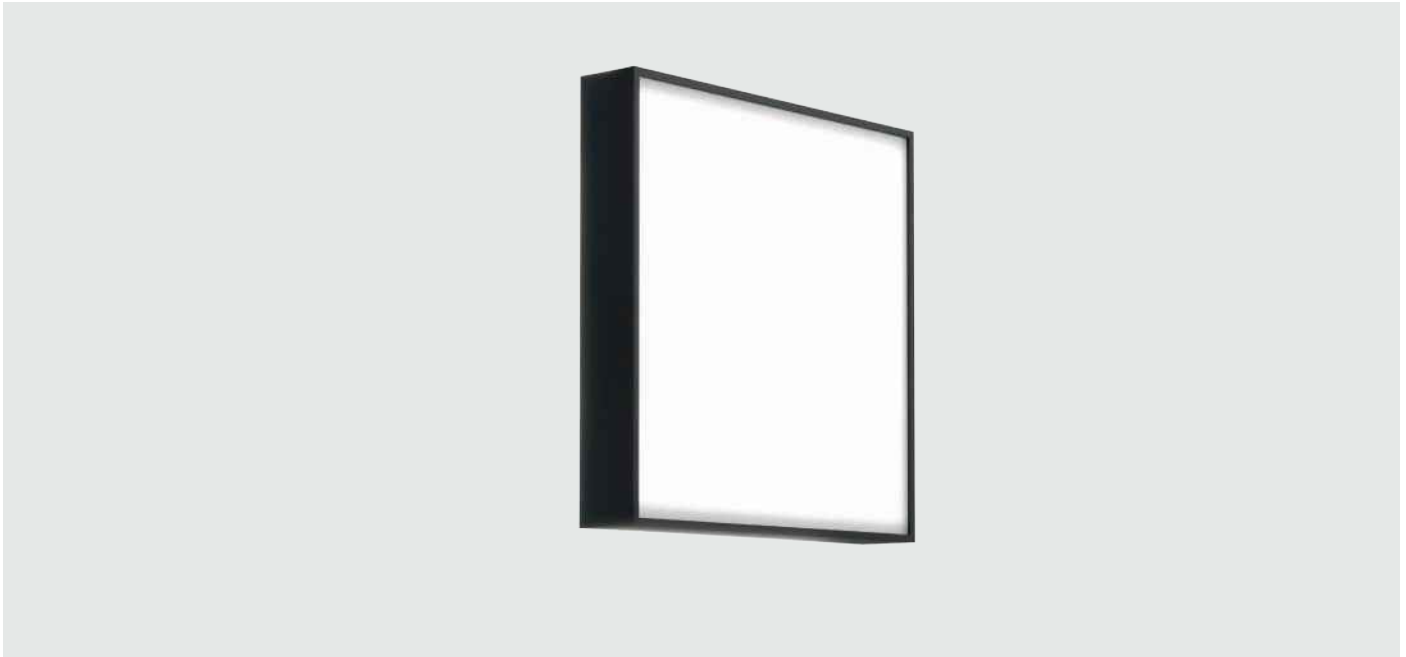

**Quadratische LED-Flächenleuchte zur Wandmontage.** Direktstrahlend oder direkt-indirektstrahlend. Gehäuse aus Aluminiumprofil, nahtlos verschweißt. Fertigung der Leuchte in vier Größen: 350, 450, 650 und 950 mm mit einer Gesamthöhe von 90 mm. Oberfläche pulverbeschichtet feinstruktur matt ähnlich RAL 9016 weiß, RAL 9006 silber oder RAL 9005 schwarz – auf Anfrage in RAL nach Wahl. Die durchdachte Konstruktion der Leuchte ermöglicht ein Design in zahlreichen Farbkombinationen – zwischen Gehäusefarbe und Dekorring kann beliebig kombiniert werden. Um der Leuchtenfamilie neben den Standardfarben einen dekorativen Touch zu verleihen, steht der Dekorring auch in den strukturierten Spezialoberflächen schlaggold, schlagsilber und schlagbronze zur Auswahl. Diffuser in PMMA wahlweise opal, mikroprismatisch inkl. Streufolie oder nur mikroprismatisch (office special) für eine reduzierte Leuchtdichte (UGR<19). Einfache Montage durch Einschieben des Leuchtengehäuses in den Baldachin. Der LED-Treiber ist im Leuchtengehäuse integriert – wahlweise als on/off oder DALI-Variante. Farbtemperaturen 2700K, 3000K, 4000K oder dynamisch Weiß (2700K–6500K) – Farbwiedergabe CRI>80 oder CRI>90 – Mac Adam ≤3. Weitere Steuerungsoptionen oder Lichtfarben auf Anfrage möglich. Außerdem ist die Integration vieler Komponenten, wie beispielsweise Notlicht oder Sensortechnologie, sowie eine Vielzahl weiterer Optionen möglich.

**Square wall-mounted LED luminaire.** Direct beam or direct-indirect beam. Housing made of aluminium profile, seamlessly welded. Luminaire manufactured in four sizes: 350, 450, 650 and 950 mm with a total height of 90 mm. Surface powder coated fine structure matt similar to RAL 9016 white, RAL 9006 silver or RAL 9005 black - on request in RAL of choice. The sophisticated construction of the luminaire allows a design in numerous colour combinations - any combination of housing colour and decorative ring is possible. To give the luminaire family a decorative touch in addition to the standard colours, the decorative ring is also available in the structured special surfaces of beaten gold, beaten silver and beaten bronze. Diffuser in PMMA either opal, microprism incl. diffuser foil or only microprism (office special) for reduced luminance (UGR<19). Easy mounting by sliding the luminaire housing into the canopy. The LED driver is integrated in the luminaire housing - either as on/off or DALI version. Colour temperatures 2700K, 3000K, 4000K or dynamic white (2700K-6500K) - colour rendering CRI>80 or CRI>90 - Mac Adam ≤3. Further control options or light colours available on request. In addition, the integration of many components, such as emergency lighting or sensor technology, as well as a variety of other options is possible.

**Luminaire mural carré LED.** Éclairage direct ou direct-indirect. Boîtier en profilé d'aluminium, soudé sans soudure. Fabrication du luminaire en quatre dimensions : 350, 450, 650 et 950 mm avec une hauteur totale de 90 mm. Surface revêtue par poudre à structure fine mate similaire à RAL 9016 blanc, RAL 9006 argent ou RAL 9005 noir - sur demande en RAL au choix. La construction bien pensée du luminaire permet un design dans de nombreuses combinaisons de couleurs - il est possible de combiner à volonté entre la couleur du boîtier et l'anneau décoratif. Pour donner à la famille de luminaires une touche décorative en plus des couleurs standard, l'anneau décoratif est également disponible dans les surfaces spéciales structurées or choc, argent choc et bronze choc. Diffuseur en PMMA au choix opale, microprismatique y compris film diffusant ou uniquement microprismatique (office special) pour un éblouissement réduit (UGR<19). Montage facile en insérant le corps du luminaire dans le canopy. Le driver LED est intégré dans le boîtier du luminaire - au choix en version on/off ou DALI. Températures de couleur 2700K, 3000K, 4000K ou blanc dynamique (2700K-6500K) - Rendu des couleurs CRI>80 ou CRI>90 - Mac Adam ≤3. Autres options de commande ou couleurs de lumière possibles sur demande. En outre, l'intégration de nombreux composants, tels que l'éclairage de secours ou la technologie des capteurs, une multitude d'autres options sont possibles.

## ÜBERSICHT | OVERVIEW | VUE D'ENSEMBLE

### TECHNICAL DATA

2700K / 3000K / 4000K / 2700-6500K

CRI>80 / CRI>90

MacAdam ≤ 3

up to 175 lm/W

on-off / DALI

direct / direct + indirect

opal / microprism / office special (UGR <19)

L80 B10 50.000h



RAL colour of your choice



Integration of Multisensor



Integration of emergency light



Contact us for more options...

### HOUSING COLOUR

schwarz | black | noir  
RAL 9005



silber | silver | argent  
RAL 9006



weiß | white | blanc  
RAL 9016



### DECORATION RING COLOUR

schwarz | black | noir  
RAL 9005



silber | silver | argent  
RAL 9006



weiß | white | blanc  
RAL 9016



schlaggold | beaten gold | or texturés



schlagsilber | beaten silver | argent texturés



schlagbronze | beaten bronze | bronze texturés



**WANDLEUCHTE „SQARE90“**  
**WALL LUMINAIRE “SQARE90”**  
**APPLIQUE MURALE « SQUARE90 »**

Bestellbeispiel | Example order | Exemple de commande  
 350 mm, CRI>90, 4000K, direct, low output on/off, black, beaten gold, microprism

**SQ90W-359401-LOBGM**

1 2 3 4 5 6 7 8

**1 GRÖSSE**  
**SIZE**  
**TAILLE**

350 x 350 mm	<b>35</b>
450 x 450 mm	<b>45</b>
650 x 650 mm	<b>65</b>
950 x 950 mm	<b>95</b>

**2 FARBWIEDERGABE**  
**COLOUR RENDERING**  
**RENDU DES COULEURS**

CRI>80	<b>8</b>
CRI>90	<b>9</b>

**3 FARBTEMPERATUR**  
**COLOUR TEMPERATURE**  
**TEMPÉRATURE DE COULEUR**

2700K (CRI>90 only)	<b>27</b>
3000K	<b>30</b>
4000K	<b>40</b>
2700-6500K (CRI>90 only)	<b>DW</b>

**4 LICHTVERTEILUNG**  
**LIGHT DISTRIBUTION**  
**DISTRIBUTION DE LA LUMIÈRE**

direct	<b>1</b>
direct + indirect	<b>2</b>

**5 LEISTUNG & STEUERUNG**  
**OUTPUT & CONTROL**  
**SORTIE & CONTRÔLE**

low output on/off	<b>LO</b>
low output DALI	<b>LD</b>
high output on/off	<b>HO</b>
high output DALI	<b>HD</b>
dynamic white DALI DT8	<b>DW</b>

**6 GEHÄUSEFARBE**  
**HOUSING COLOUR**  
**COULEUR DU BOÎTIER**

black RAL 9005	<b>B</b>
silver RAL 9006	<b>S</b>
white RAL 9016	<b>W</b>

**7 DEKORRING FARBE**  
**DECORATION RING COLOUR**  
**BAGUE DÉCORATIVE COULEUR**

black RAL 9005	<b>B</b>
silver RAL 9006	<b>S</b>
white RAL 9016	<b>W</b>
beaten gold	<b>G</b>
beaten silver	<b>A</b>
beaten bronze	<b>C</b>

**8 DIFFUSOR**  
**DIFFUSER**  
**DIFFUSEUR**

opal	<b>O</b>
microprism	<b>M</b>
office special	<b>B</b>

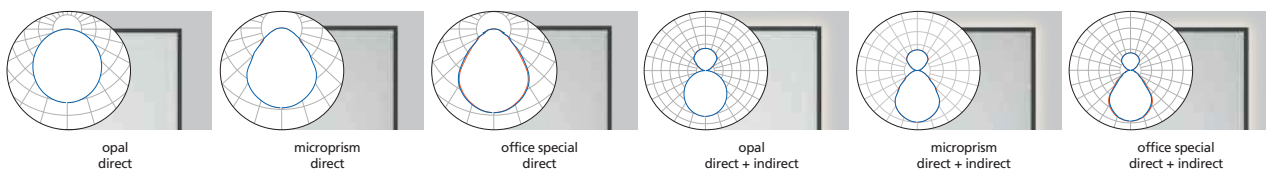
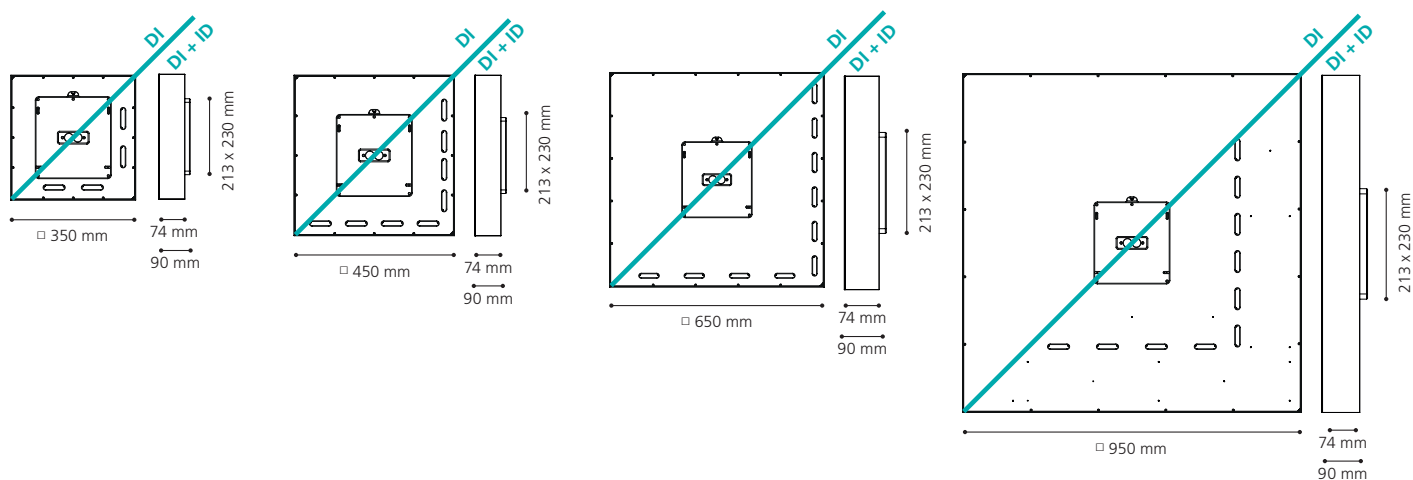

Size [mm]	opal direct		microprism direct		office special direct		opal direct + indirect		microprism direct + indirect		office special direct + indirect		kg
	low output [lm] / [W]	high output [lm] / [W]	low output [lm] / [W]	high output [lm] / [W]	low output [lm] / [W]	high output [lm] / [W]	low output [lm] / [W]	high output [lm] / [W]	low output [lm] / [W]	high output [lm] / [W]	low output [lm] / [W]	high output [lm] / [W]	
□ 350	1.349 / 9,9	2.365 / 16,7	1.256 / 9,9	2.208 / 16,7	1.402 / 9,9	2.470 / 16,7	2.029 / 13,8	3.488 / 23,1	1.923 / 13,8	3.308 / 23,1	2.081 / 13,8	3.579 / 23,1	3,9
□ 450	2.288 / 15,4	4.011 / 26,0	2.130 / 15,4	3.744 / 26,0	2.377 / 15,4	4.189 / 26,0	3.236 / 20,7	5.563 / 34,6	3.067 / 20,7	5.276 / 34,6	3.319 / 20,7	5.709 / 34,6	5,4
□ 650	4.711 / 30,5	8.258 / 51,6	4.385 / 30,5	7.708 / 51,6	4.894 / 30,5	8.624 / 51,6	5.845 / 37,0	10.048 / 61,8	5.845 / 37,0	9.530 / 61,8	5.995 / 37,0	10.312 / 61,8	9,3
□ 950	9.868 / 60,9	17.299 / 102,8	9.187 / 60,9	16.148 / 102,8	10.252 / 60,9	18.067 / 102,8	10.918 / 67,4	18.770 / 112,6	10.348 / 67,4	17.801 / 112,6	11.198 / 67,4	19.262 / 112,6	23,4

Alle Lumenangaben für 4000K, CRI>80, Gehäusefarbe weiß  
 All lumen values for 4000K, CRI>80, housing colour white  
 Toutes les données de lumens pour 4000K, CRI>80, couleur du boîtier blanc

# OVERVIEW

EINBAULEUCHTEN | RECESSED LUMINAIRES | LUMINAIRES ENCASTRABLES



LINE40  
**194**



LINE50  
**196**



LINE50splash  
**198**



officeLINE50  
**200**



LINE70  
**202**



RING50  
**204**



FLEX50  
**206**



ROUND90  
**208**



DOWN75  
**210**



designDOT  
**212**



designSQOT  
**214**



techDOT  
**216**



techSQOT  
**218**

# EINBAULEUCHTEN

RECESSED LUMINAIRES

*LUMINAIRES ENCASTRABLES*

# LINE40

EINBAULEUCHE | RECESSED LUMINAIRE | LUMINAIRE ENCASTRABLE

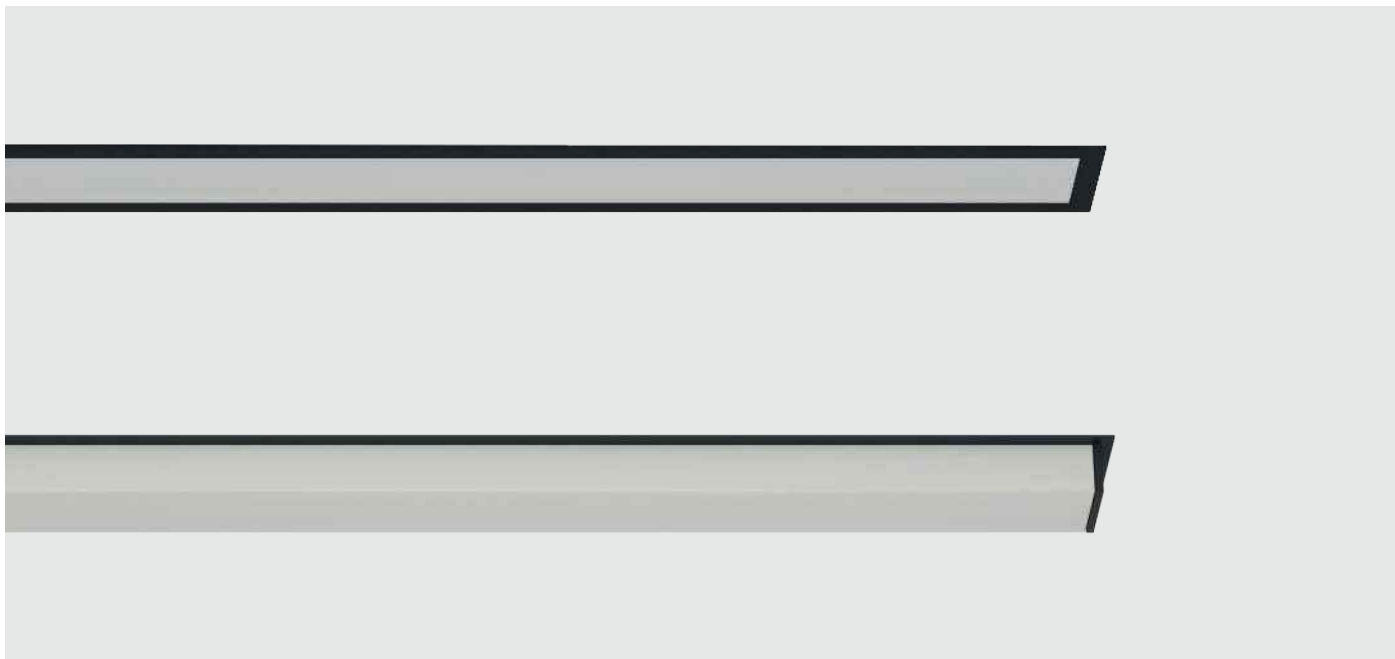

**LED-Einbauleuchte** mit umlaufendem Rahmen, direktstrahlend. Lichtkanal aus Aluminium-Strangpressprofil mit einer Gesamtbreite von 54 mm. Fertigung der Leuchtenlänge millimetergenau auf Kundenwunsch möglich. Oberfläche der Leuchte feinstruktur matt pulverbeschichtet ähnlich RAL 9016 weiß, RAL 9006 silber oder RAL 9005 schwarz – auf Anfrage in RAL nach Wahl. Diffusor wahlweise in PMMA opal, oder PMMA klar mit eingeschobener mikroprismatischer Platte für eine reduzierte Leuchtdichte (UGR<19). Der LED-Treiber ist im Leuchtengehäuse integriert – wahlweise als on/off oder DALI-Variante. Farbtemperaturen 2700K, 3000K, 4000K oder dynamisch Weiß (2700K-6500K) – Farbwiedergabe CRI>80 oder CRI>90 – Mac Adam ≤3. Weitere Steuerungsoptionen oder Lichtfarben auf Anfrage erhältlich. Außerdem ist die Integration vieler Komponenten, wie beispielsweise Notlicht oder Sensortechnologie, sowie eine Vielzahl weiterer Optionen möglich.

**Recessed LED luminaire** with surrounding frame, direct beam. Light channel made of extruded aluminium profile with a total width of 54 mm. Luminaire length can be manufactured to the exact millimetre on customer request. Surface of the luminaire fine structure matt powder coated similar to RAL 9016 white, RAL 9006 silver or RAL 9005 black - on request in RAL of choice. Diffuser either in PMMA opal or PMMA clear with inserted microprismatic plate for reduced luminance (UGR<19). The LED driver is integrated in the luminaire housing - either as on/off or DALI version. Colour temperatures 2700K, 3000K, 4000K or dynamic white (2700K-6500K) - colour rendering CRI>80 or CRI>90 - Mac Adam ≤3. Further control options or light colours available on request. In addition, the integration of many components, such as emergency lighting or sensor technology, as well as a variety of other options is possible.

**Luminaire LED encastré** avec cadre périphérique à éclairage direct. Canal lumineux en profilé d'aluminium extrudé d'une largeur totale de 54 mm. Fabrication de la longueur du luminaire au millimètre près possible sur demande du client. Surface du luminaire à structure fine, revêtement par poudre mat similaire à RAL 9016 blanc, RAL 9006 argent ou RAL 9005 noir - sur demande en RAL au choix. Diffuseur au choix en PMMA opale ou en PMMA transparent avec plaque microprismatique insérée pour un éblouissement réduit (UGR<19). Le pilote LED est intégré dans le boîtier du luminaire - au choix sous forme de variante on/off ou DALI. Températures de couleur 2700K, 3000K, 4000K ou blanc dynamique (2700K-6500K) - Rendu des couleurs CRI>80 ou CRI>90 - Mac Adam ≤3. Autres options de commande ou couleurs de lumière disponibles sur demande. En outre, l'intégration de nombreux composants, tels que l'éclairage de secours ou des capteurs, une multitude d'autres options sont possibles.

## ÜBERSICHT | OVERVIEW | VUE D'ENSEMBLE

### TECHNICAL DATA

2700K / 3000K / 4000K / 2700-6500K

CRI>80 / CRI>90

MacAdam ≤ 3

up to 124 lm/W, up to 2.849 lm/m

on-off / DALI

direct

opal / U-cover / microprism (UGR <19)

L80 B10 50.000h

### HOUSING COLOUR

schwarz | black | *noir*  
RAL 9005

silber | silver | *argent*  
RAL 9006

weiß | white | *blanc*  
RAL 9016



RAL colour of your choice



Integration of Multisensor



Welded mitre cuts



Integration of emergency light



Contact us for more options...

**EINBAULEUCHE „LINE40“**  
**RECESSED LUMINAIRE “LINE40”**  
**LUMINAIRE ENCASTRABLE « LINE40 »**

Bestellbeispiel | Example order | Exemple de commande  
 3.141 mm, CRI>90, 4000K, **direct**, low output on/off, black, microprism

**LI40E-319401-LOBLM**

1 2 3 4 5 6

**1 LÄNGE**  
**LENGTH**  
**LONGUEUR**

621 mm	<b>06</b>
981 mm	<b>09</b>
1.221 mm	<b>12</b>
1.461 mm	<b>14</b>
1.701 mm	<b>17</b>
1.941 mm	<b>19</b>
2.181 mm	<b>21</b>
2.421 mm	<b>24</b>
2.901 mm	<b>29</b>
3.141 mm	<b>31</b>
3.863 mm	<b>38</b>

**2 FARBWIEDERGABE**  
**COLOUR RENDERING**  
**RENDU DES COULEURS**

CRI>80	<b>8</b>
CRI>90	<b>9</b>

**3 FARBTEMPERATUR**  
**COLOUR TEMPERATURE**  
**TEMPÉRATURE DE COULEUR**

2700K (CRI>90 only)	<b>27</b>
3000K	<b>30</b>
4000K	<b>40</b>
2700-6500K (CRI>90 only)	<b>DW</b>

**4 LEISTUNG & STEUERUNG**  
**OUTPUT & CONTROL**  
**SORTIE & CONTRÔLE**

low output on/off	<b>LO</b>
low output DALI	<b>LD</b>
high output on/off	<b>HO</b>
high output DALI	<b>HD</b>
dynamic white DALI DT8	<b>DW</b>

**5 GEHÄUSEFARBE**  
**HOUSING COLOUR**  
**COULEUR DU BOÎTIER**

silver RAL 9006	<b>SI</b>
white RAL 9016	<b>WH</b>
black RAL 9005	<b>BL</b>

**6 DIFFUSOR**  
**DIFFUSER**  
**DIFFUSEUR**

opal	<b>O</b>
microprism	<b>M</b>
U-cover	<b>U</b>

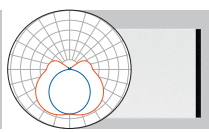
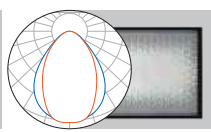
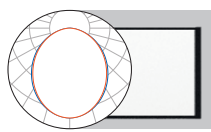
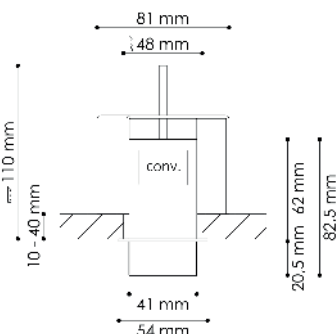
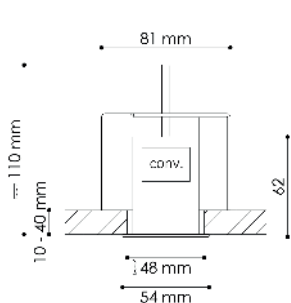

opal direct

microprism direct

U-cover direct

Size [mm]	low output [lm] / [W]	high output [lm] / [W]	low output [lm] / [W]	high output [lm] / [W]	low output [lm] / [W]	high output [lm] / [W]	
621	840 / 8,8	1.495 / 16,3	876 / 8,8	1.560 / 16,3	864 / 8,8	1.538 / 16,3	1,4
981	1.324 / 13,0	2.461 / 25,0	1.381 / 13,0	2.567 / 25,0	1.362 / 13,0	2.532 / 25,0	2,1
1.221	1.777 / 16,3	3.150 / 30,0	1.854 / 16,3	3.286 / 30,0	1.828 / 16,3	3.241 / 30,0	2,7
1.461	2.010 / 18,5	3.763 / 35,8	2.097 / 18,5	3.925 / 35,8	2.068 / 18,5	3.871 / 35,8	3,2
1.701	2.398 / 21,2	4.470 / 41,1	2.501 / 21,2	4.663 / 41,1	2.467 / 21,2	4.599 / 41,1	3,8
1.941	2.779 / 23,7	5.222 / 46,3	2.889 / 23,7	5.448 / 46,3	2.859 / 23,7	5.373 / 46,3	4,3
2.181	3.157 / 26,6	5.931 / 52,0	3.293 / 26,6	6.187 / 52,0	3.248 / 26,6	6.102 / 52,0	4,8
2.421	3.441 / 29,2	6.544 / 57,3	3.590 / 29,2	6.826 / 57,3	3.541 / 29,2	6.732 / 57,3	5,4
2.901	3.880 / 34,3	7.570 / 69,6	4.048 / 34,3	7.897 / 69,6	3.992 / 34,3	7.788 / 69,6	6,5
3.141	4.326 / 36,9	8.516 / 75,5	4.513 / 36,9	8.884 / 75,5	4.451 / 36,9	8.761 / 75,5	6,9
3.863	5.558 / 47,4	10.444 / 92,6	5.798 / 47,4	10.896 / 92,6	5.718 / 47,4	10.746 / 92,6	8,6



**CUTOUT**

Size [mm]	length [mm]	width [mm]	depth [mm]
621	616	48	110
981	976	48	110
1.221	1.216	48	110
1.461	1.456	48	110
1.701	1.696	48	110
1.941	1.936	48	110
2.181	2.176	48	110
2.421	2.416	48	110
2.901	2.896	48	110
3.141	3.136	48	110
3.863	3.858	48	110

Alle Lumenangaben für 4000K, CRI>80, Microprisma ohne Opalfolie  
 All lumen values for 4000K, CRI>80, microprism without opal foil  
 Toutes les données de lumens pour 4000K, CRI>80, microprisme sans feuille opale



# LINE50

EINBAULEUCHE | RECESSED LUMINAIRE | LUMINAIRE ENCASTRABLE



**LED-Einbauleuchte** mit umlaufendem Rahmen, direktstrahlend. Lichtkanal aus Aluminium-Strangpressprofil mit einer Gesamtbreite von 63 mm. Fertigung der Leuchtenlänge millimetergenau auf Kundenwunsch möglich. Oberfläche der Leuchte feinstruktur matt pulverbeschichtet ähnlich RAL 9016 weiß, RAL 9006 silber oder RAL 9005 schwarz – auf Anfrage in RAL nach Wahl. Diffusor wahlweise in PMMA opal, PMMA klar mit eingeschobener mikroprismatischer Platte für eine reduzierte Leuchtdichte (UGR<19). Der LED-Treiber ist im Leuchtengehäuse integriert – wahlweise als on/off oder DALI-Variante. Farbtemperaturen 2700K, 3000K, 4000K oder dynamisch Weiß (2700K–6500K) – Farbwiedergabe CRI>80 oder CRI>90 – Mac Adam ≤3. Weitere Steuerungsoptionen oder Lichtfarben auf Anfrage erhältlich. Außerdem ist die Integration vieler Komponenten, wie beispielsweise Notlicht oder Sensortechnologie, sowie eine Vielzahl weiterer Optionen möglich.

**Recessed LED luminaire** with surrounding frame, direct beam. Light channel made of extruded aluminium profile with a total width of 63 mm. Luminaire length can be manufactured to the exact millimetre on customer request. Surface of the luminaire fine structure matt powder coated similar to RAL 9016 white, RAL 9006 silver or RAL 9005 black - on request in RAL of choice. Diffuser either in PMMA opal, PMMA clear with inserted asymmetrical foil or PMMA clear with inserted microprismatic plate for reduced luminance (UGR<19). The LED driver is integrated in the luminaire housing - either as on/off or DALI version. Colour temperatures 2700K, 3000K, 4000K or dynamic white (2700K-6500K) - colour rendering CRI>80 or CRI>90 - Mac Adam ≤3. Further control options or light colours available on request. In addition, the integration of many components, such as emergency lighting or sensor technology, as well as a variety of other options is possible.

**Luminaire LED encastré** avec cadre périphérique à éclairage direct. Canal lumineux en profilé d'aluminium extrudé d'une largeur totale de 63 mm. Fabrication de la longueur du luminaire au millimètre près possible sur demande du client. Surface du luminaire à structure fine, revêtement par poudre mat similaire à RAL 9016 blanc, RAL 9006 argent ou RAL 9005 noir - sur demande en RAL au choix. Diffuseur au choix en PMMA opale, PMMA transparent avec feuille asymétrique insérée ou PMMA transparent avec plaque microprismatique insérée pour un éblouissement réduit (UGR<19). Le pilote LED est intégré dans le boîtier du luminaire - au choix sous forme de variante on/off ou DALI. Températures de couleur 2700K, 3000K, 4000K ou blanc dynamique (2700K-6500K) - Rendu des couleurs CRI>80 ou CRI>90 - Mac Adam ≤3. Autres options de commande ou couleurs de lumière disponibles sur demande. En outre, l'intégration de nombreux composants, tels que l'éclairage de secours ou la technologie de détection, une multitude d'autres options sont possibles.

## ÜBERSICHT | OVERVIEW | VUE D'ENSEMBLE

### TECHNICAL DATA

2700K / 3000K / 4000K / 2700-6500K

CRI>80 / CRI>90

MacAdam ≤ 3

up to 130 lm/W, up to 2.939 lm/m

on-off / DALI

direct

opal / microprism (UGR <19)

L80 B10 50.000h

### HOUSING COLOUR

schwarz | black | *noir*  
RAL 9005



silber | silver | *argent*  
RAL 9006



weiß | white | *blanc*  
RAL 9016



RAL colour of your choice



Integration of 3-phase-track



Integration of Multisensor



Welded mitre cuts



Integration of emergency light



Integration of GLOWmini/  
GLOWsmall series



Contact us for more options...

**EINBAULEUCHE „LINE50“**  
**RECESSED LUMINAIRE “LINE50”**  
**LUMINAIRE ENCASTRABLE « LINE50 »**

Bestellbeispiel | Example order | Exemple de commande  
 3.141 mm, CRI>90, 4000K, **direct**, low output on/off, black, microprism

**LI50E-319401-LOBLM**

1 2 3 4 5 6

**1 LÄNGE**  
**LENGTH**  
**LONGEUR**

621 mm	<b>06</b>
981 mm	<b>09</b>
1.221 mm	<b>12</b>
1.461 mm	<b>14</b>
1.701 mm	<b>17</b>
1.941 mm	<b>19</b>
2.181 mm	<b>21</b>
2.421 mm	<b>24</b>
2.901 mm	<b>29</b>
3.141 mm	<b>31</b>
3.863 mm	<b>38</b>

**2 FARBWIEDERGABE**  
**COLOUR RENDERING**  
**RENDU DES COULEURS**

CRI>80	<b>8</b>
CRI>90	<b>9</b>

**3 FARBTEMPERATUR**  
**COLOUR TEMPERATURE**  
**TEMPÉRATURE DE COULEUR**

2700K (CRI>90 only)	<b>27</b>
3000K	<b>30</b>
4000K	<b>40</b>
2700-6500K (CRI>90 only)	<b>DW</b>

**4 LEISTUNG & STEUERUNG**  
**OUTPUT & CONTROL**  
**SORTIE & CONTRÔLE**

low output on/off	<b>LO</b>
low output DALI	<b>LD</b>
high output on/off	<b>HO</b>
high output DALI	<b>HD</b>
dynamic white DALI DT8	<b>DW</b>

**5 GEHÄUSEFARBE**  
**HOUSING COLOUR**  
**COULEUR DU BOÎTIER**

silver RAL 9006	<b>SI</b>
white RAL 9016	<b>WH</b>
black RAL 9005	<b>BL</b>

**6 DIFFUSOR**  
**DIFFUSER**  
**DIFFUSEUR**

opal	<b>O</b>
microprism	<b>M</b>
asymmetric	<b>A</b>

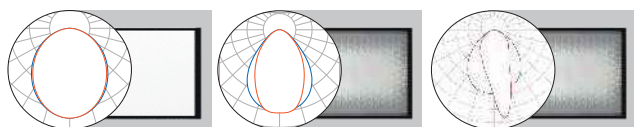
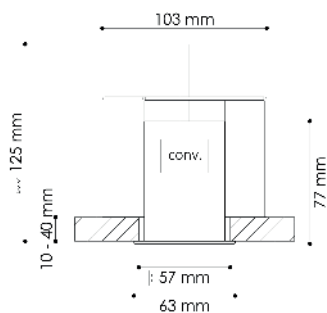

opal direct

microprism direct

asymmetric direct

Size [mm]	low output [lm] / [W]		high output [lm] / [W]		low output [lm] / [W]		high output [lm] / [W]		kg
	low	high	low	high	low	high	low	high	
621	909	8,8	1.731	16,3	826	8,8	1.581	16,3	1,5
981	1455	13,0	2.770	25,0	1.321	13,0	2.530	25,0	2,3
1.221	1.818	16,3	3.463	30,0	1.652	16,3	3.162	30,0	2,9
1.461	2.182	18,5	4.156	35,8	1.982	18,5	3.794	35,8	3,5
1.701	2.546	21,2	4.848	41,1	2.313	21,2	4.427	41,1	4,1
1.941	2.911	23,7	5.541	46,3	2.642	23,7	5.059	46,3	4,6
2.181	3.273	26,6	6.233	52,0	2.974	26,6	5.692	52,0	5,2
2.421	3.635	29,2	6.926	57,3	3.304	29,2	6.324	57,3	5,8
2.901	4.364	34,3	8.311	69,6	3.964	34,3	7.589	69,6	7,0
3.141	4.728	36,9	9.004	75,5	4.295	36,9	8.221	75,5	7,5
3.863	5.821	47,4	11.082	92,6	5.284	47,4	10.118	92,6	9,3



**CUTOUT**

Size [mm]	length [mm]	width [mm]	depth [mm]
621	616	57	125
981	976	57	125
1.221	1.216	57	125
1.461	1.456	57	125
1.701	1.696	57	125
1.941	1.936	57	125
2.181	2.176	57	125
2.421	2.416	57	125
2.901	2.896	57	125
3.141	3.136	57	125
3.863	3.858	57	125

Alle Lumenangaben für 4000K, CRI>80, Microprisma ohne Opalfolie  
 All lumen values for 4000K, CRI>80, microprism without opal foil  
 Toutes les données de lumens pour 4000K, CRI>80, microprisme sans feuille opale

# LINE50splash

EINBAULEUCHE | RECESSED LUMINAIRE | LUMINAIRE ENCASTRABLE

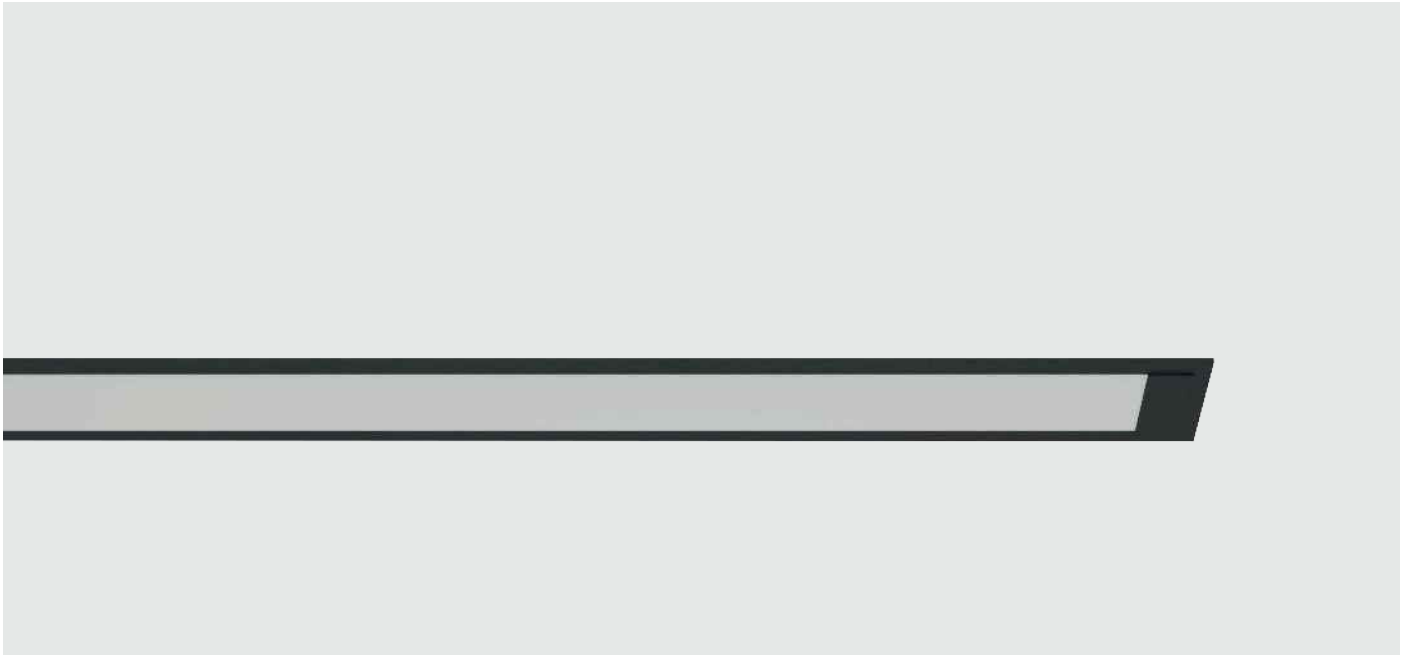

**LED-Einbauleuchte** mit erhöhter Schutzart IP54 mit umlaufendem Rahmen direktstrahlend. Lichtkanal aus Aluminium-Strangpressprofil mit einer Breite von 63 mm. Oberfläche der Leuchte feinstruktur matt pulverbeschichtet ähnlich RAL 9016 weiß, RAL 9006 silber oder RAL 9005 schwarz – auf Anfrage in RAL nach Wahl. Diffusor wahlweise in PMMA opal, PMMA klar mit eingeschobener asymmetrischer Folie oder PMMA klar mit eingeschobener mikroprismatischer Platte für eine reduzierte Leuchtdichte (UGR<19). Der LED-Treiber ist im Leuchtgehäuse integriert – wahlweise als on/off oder DALI-Variante – Farbtemperaturen 2700K, 3000K, 4000K oder dynamisch Weiß (2700K–6500K) – Farbwiedergabe CRI>80 oder CRI>90 – Mac Adam ≤3. Weitere Steuerungsoptionen oder Lichtfarben auf Anfrage erhältlich. Außerdem ist die Integration vieler Komponenten, wie beispielsweise Notlicht, sowie eine Vielzahl weiterer Optionen möglich.

**Recessed LED luminaire** with surrounding frame with increased protection rating IP54 and direct beam. Light channel made of extruded aluminium profile with a width of 63 mm. Surface of the luminaire fine structure matt powder coated similar to RAL 9016 white, RAL 9006 silver or RAL 9005 black - on request in RAL of choice. Diffuser either in PMMA opal, PMMA clear with inserted asymmetric foil or PMMA clear with inserted microprismatic plate for reduced luminance (UGR<19). The LED driver is integrated in the luminaire housing - either as on/off or DALI version - colour temperatures 2700K, 3000K, 4000K or dynamic white (2700K-6500K) - colour rendering CRI>80 or CRI>90 - Mac Adam ≤3. Further control options or light colours available on request. In addition, the integration of many components, such as emergency lighting, as well as a variety of other options is possible.

**Luminaire LED encastré** avec cadre périphérique et avec un degré de protection élevé IP54 à éclairage direct. Canal lumineux en profilé d'aluminium extrudé d'une largeur de 63 mm. Surface du luminaire à structure fine, revêtement par poudre mat similaire à RAL 9016 blanc, RAL 9006 argent ou RAL 9005 noir - sur demande en RAL au choix. Diffuseur au choix en PMMA opale, PMMA transparent avec feuille asymétrique insérée ou PMMA transparent avec plaque microprismatique insérée pour un éblouissement réduit (UGR<19). Le pilote LED est intégré dans le boîtier du luminaire - au choix sous forme de variante on/off ou DALI - températures de couleur 2700K, 3000K, 4000K ou blanc dynamique (2700K-6500K) - rendu des couleurs CRI>80 ou CRI>90 - Mac Adam ≤3. Autres options de commande ou couleurs de lumière disponibles sur demande. En outre, l'intégration de nombreux composants, tels que l'éclairage de secours, une multitude d'autres options sont possibles.

## ÜBERSICHT | OVERVIEW | VUE D'ENSEMBLE

### TECHNICAL DATA

2700K / 3000K / 4000K / 2700-6500K

CRI>80 / CRI>90

MacAdam ≤ 3

up to 130 lm/W, up to 2.930 lm/m

on-off / DALI

direct

opal / microprism (UGR <19) / asymmetric

L80 B10 50.000h

### HOUSING COLOUR

schwarz | black | noir  
RAL 9005

silber | silver | argent  
RAL 9006

weiß | white | blanc  
RAL 9016



RAL colour of your choice



Integration of emergency light



Contact us for more options...

**EINBAULEUCHE „LINE50splash“**  
 RECESSED LUMINAIRE “LINE50splash”  
 LUMINAIRE ENCASTRABLE « LINE50splash »

Bestellbeispiel | Example order | Exemple de commande  
 3.152 mm, CRI90, 4000K, direct, low output on/off, black, microprism

**LS50E-319401-LOBLM**

1 2 3 4 5 6

**1 LÄNGE**  
 LENGTH  
 LONGEUR

632 mm	<b>06</b>
992 mm	<b>09</b>
1.232 mm	<b>12</b>
1.472 mm	<b>14</b>
1.712 mm	<b>17</b>
1.952 mm	<b>19</b>
2.192 mm	<b>21</b>
2.432 mm	<b>24</b>
2.912 mm	<b>29</b>
3.152 mm	<b>31</b>
3.874 mm	<b>38</b>

**2 FARBWIEDERGABE**  
 COLOUR RENDERING  
 RENDU DES COULEURS

CRI>80	<b>8</b>
CRI>90	<b>9</b>

**3 FARBTEMPERATUR**  
 COLOUR TEMPERATURE  
 TEMPÉRATURE DE COULEUR

2700K (CRI>90 only)	<b>27</b>
3000K	<b>30</b>
4000K	<b>40</b>
2700-6500K (CRI>90 only)	<b>DW</b>

**4 LEISTUNG & STEUERUNG**  
 OUTPUT & CONTROL  
 SORTIE & CONTRÔLE

low output on/off	<b>LO</b>
low output DALI	<b>LD</b>
high output on/off	<b>HO</b>
high output DALI	<b>HD</b>
dynamic white DALI DT8	<b>DW</b>

**5 GEHÄUSEFARBE**  
 HOUSING COLOUR  
 COULEUR DU BOÎTIER

silver RAL 9006	<b>SI</b>
white RAL 9016	<b>WH</b>
black RAL 9005	<b>BL</b>

**6 DIFFUSOR**  
 DIFFUSER  
 DIFFUSEUR

opal	<b>O</b>
microprism	<b>M</b>
asymmetric	<b>A</b>

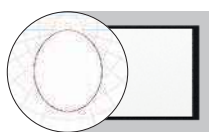
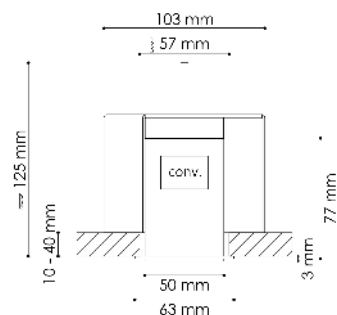

opal direct

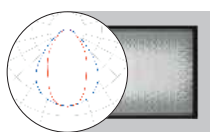

microprism direct

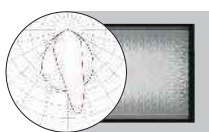

asymmetric direct

direct



**CUTOUT**

Size [mm]	low output [lm] / [W]	high output [lm] / [W]	low output [lm] / [W]	high output [lm] / [W]	low output [lm] / [W]	high output [lm] / [W]	38 kg
632	908 / 8,8	1.731 / 16,3	826 / 8,8	1.731 / 16,3	867 / 8,8	1.660 / 16,3	1,9
992	1.455 / 13,0	2.770 / 25,0	1.321 / 13,0	2.770 / 25,0	1.387 / 13,0	2.656 / 25,0	2,7
1.232	1.818 / 16,3	3.463 / 30,0	1.652 / 16,3	3.162 / 30,0	1.735 / 16,3	3.320 / 30,0	3,3
1.472	2.182 / 18,5	4.156 / 35,8	1.982 / 18,5	3.794 / 35,8	2.081 / 18,5	3.984 / 35,8	3,9
1.712	2.546 / 21,2	4.848 / 41,1	2.313 / 21,2	4.427 / 41,1	2.429 / 21,2	4.648 / 41,1	4,5
1.952	2.911 / 23,7	5.541 / 46,3	2.642 / 23,7	5.059 / 46,3	2.774 / 23,7	5.312 / 46,3	5,0
2.192	3.273 / 26,6	6.233 / 52,0	2.974 / 26,6	5.692 / 52,0	3.123 / 26,6	5.977 / 52,0	5,6
2.432	3.635 / 29,2	6.926 / 57,3	3.304 / 29,2	6.324 / 57,3	3.469 / 29,2	6.640 / 57,3	6,2
2.912	4.364 / 34,3	8.311 / 69,6	3.964 / 34,3	7.589 / 69,6	4.162 / 34,3	7.968 / 69,6	7,4
3.152	4.728 / 36,9	9.004 / 75,5	4.295 / 36,9	8.221 / 75,5	4.510 / 36,9	8.632 / 75,5	7,9
3.874	5.821 / 47,4	11.082 / 92,6	5.284 / 47,4	10.118 / 92,6	5.548 / 47,4	10.624 / 92,6	9,7

Size [mm]	length [mm]	width [mm]	depth [mm]
632	628	57	125
992	988	57	125
1.232	1.228	57	125
1.472	1.468	57	125
1.712	1.708	57	125
1.952	1.948	57	125
2.192	2.188	57	125
2.432	2.428	57	125
2.912	2.908	57	125
3.152	3.148	57	125
3.874	3.870	57	125

Alle Lumenangaben für 4000K, CRI>80, Microprisma ohne Opalfolie  
 All lumen values for 4000K, CRI>80, microprism without opal foil  
 Toutes les données de lumens pour 4000K, CRI>80, microprisme sans feuille opale

# officeLINE50

Einbauleuchte | Recessed Luminaire | Luminaire Encastrable



**LED-Einbauleuchte** mit umlaufendem Rahmen, direktstrahlend. Lichtkanal aus Aluminium-Strangpressprofil mit einer Gesamtbreite von 63 mm. Fertigung der Leuchtenlänge millimetergenau auf Kundenwunsch möglich. Oberfläche der Leuchte feinstruktur matt pulverbeschichtet ähnlich RAL 9016 weiß, RAL 9006 silber oder RAL 9005 schwarz – auf Anfrage in RAL nach Wahl. Die Leuchte ist ausgestattet mit einem hochwertigen, facettierten BAP-Raster mit einer Auswahl an sieben verschiedenen Farben – Oberfläche hochglänzend bzw. matt. Der LED-Treiber ist im Leuchtengehäuse integriert – wahlweise als on/off oder DALI-Variante. Farbtemperaturen 2700K, 3000K, 4000K oder dynamisch Weiß (2700K–6500K) – Farbwiedergabe CRI>80 oder CRI>90 – Mac Adam ≤3. Weitere Steuerungsoptionen oder Lichtfarben auf Anfrage erhältlich. Außerdem ist die Integration vieler Komponenten, wie beispielsweise Notlicht oder Sensortechnologie, sowie eine Vielzahl weiterer Optionen möglich.

**Recessed LED luminaire** with surrounding frame, direct beam. Light channel made of extruded aluminium profile with a total width of 63 mm. Luminaire length can be manufactured to the exact millimetre on customer request. Surface of the luminaire fine structure matt powder coated similar to RAL 9016 white, RAL 9006 silver or RAL 9005 black - on request in RAL of choice. The luminaire is equipped with a high-quality, faceted BAP louvre with a choice of seven different colours - specular or matt finish. The LED driver is integrated in the luminaire housing - either as on/off or DALI version. Colour temperatures 2700K, 3000K, 4000K or dynamic white (2700K-6500K) - Colour rendering CRI>80 or CRI>90 - Mac Adam ≤3. Further control options or light colours available on request. In addition, the integration of many components, such as emergency lighting or sensor technology, as well as a variety of other options is possible.

**Luminaire LED encastré** avec cadre périphérique à éclairage direct. Canal lumineux en profilé d'aluminium extrudé d'une largeur totale de 63 mm. Fabrication de la longueur du luminaire au millimètre près possible sur demande du client. Surface du luminaire à structure fine matte revêtue par poudre similaire à RAL 9016 blanc, RAL 9006 argent ou RAL 9005 noir - sur demande en RAL au choix. Le luminaire est équipé d'une grille BAP à facettes de haute qualité avec un choix de sept couleurs différentes - surface brillante ou mate. Le pilote LED est intégré dans le boîtier du luminaire - au choix sous forme de variante on/off ou DALI. Températures de couleur 2700K, 3000K, 4000K ou blanc dynamique (2700K-6500K) -Rendu des couleurs CRI>80 ou CRI>90 - Mac Adam ≤3. Autres options de commande ou couleurs de lumière disponibles sur demande. En outre, l'intégration de nombreux composants, tels que l'éclairage de secours ou la technologie de détection, une multitude d'autres options sont possibles.

## ÜBERSICHT | OVERVIEW | VUE D'ENSEMBLE

### TECHNICAL DATA

2700K / 3000K / 4000K / 2700-6500K

CRI>80 / CRI>90

MacAdam ≤ 3

up to 152 lm/W, up to 4.383 lm/m

on-off / DALI

direct

BAP-Louvre (UGR <19)

L80 B10 50.000h



RAL colour of your choice



Integration of 3-phase-track



Integration of Multisensor



Welded mitre cuts



Integration of emergency light



Integration of GLOWmini/  
GLOWsmall series



Contact us for more options...

### HOUSING COLOUR

schwarz | black | noir  
RAL 9005



silber | silver | argent  
RAL 9006



weiß | white | blanc  
RAL 9016



### DECORATION RING COLOUR

silber hochglanz | silver specular | argenté brillant



gold hochglanz | gold specular | doré brillant



silber matt | silver matt | argenté mat



bronze hochglanz | bronze specular | bronze brillant



schwarz hochglanz | black specular | noir brillant



titan hochglanz | titan specular | titan brillant



schwarz matt | black matt | noir mat



**EINBAULEUCHE „officeLINE50“**  
**RECESSED LUMINAIRE “officeLINE50”**  
**LUMINAIRE ENCASTRABLE « officeLINE50 »**

Bestellbeispiel | Example order | Exemple de commande  
 3.379 mm, CRI>90, 4000K, **direct**, low output on/off, black, gold specular

**OL50E-339401-LOBLG**

1 2 3 4 5 6

**1 LÄNGE**  
**LENGTH**  
**LONGEUR**

498 mm	<b>04</b>
978 mm	<b>09</b>
1.218 mm	<b>12</b>
1.458 mm	<b>14</b>
1.698 mm	<b>16</b>
2.178 mm	<b>21</b>
2.898 mm	<b>28</b>
3.379 mm	<b>33</b>

**2 FARBWIEDERGABE**  
**COLOUR RENDERING**  
**RENDU DES COULEURS**

CRI>80	<b>8</b>
CRI>90	<b>9</b>

**3 FARBTEMPERATUR**  
**COLOUR TEMPERATURE**  
**TEMPÉRATURE DE COULEUR**

2700K (CRI>90 only)	<b>27</b>
3000K	<b>30</b>
4000K	<b>40</b>
2700-6500K (CRI>90 only)	<b>DW</b>

**4 LEISTUNG & STEUERUNG**  
**OUTPUT & CONTROL**  
**SORTIE & CONTRÔLE**

low output on/off	<b>LO</b>
low output DALI	<b>LD</b>
high output on/off	<b>HO</b>
high output DALI	<b>HD</b>
dynamic white DALI DT8	<b>DW</b>

**5 GEHÄUSEFARBE**  
**HOUSING COLOUR**  
**COULEUR DU BOÎTIER**

silver RAL 9006	<b>SI</b>
white RAL 9016	<b>WH</b>
black RAL 9005	<b>BL</b>

**6 BAP-RASTER FARBE**  
**BAP LOUVRE COLOUR**  
**GRILLE BAP COULEUR**

silver specular	<b>S</b>
silver matt	<b>M</b>
black specular	<b>N</b>
black matt	<b>B</b>
gold specular	<b>G</b>
bronze specular	<b>C</b>
titan specular	<b>T</b>

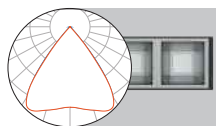
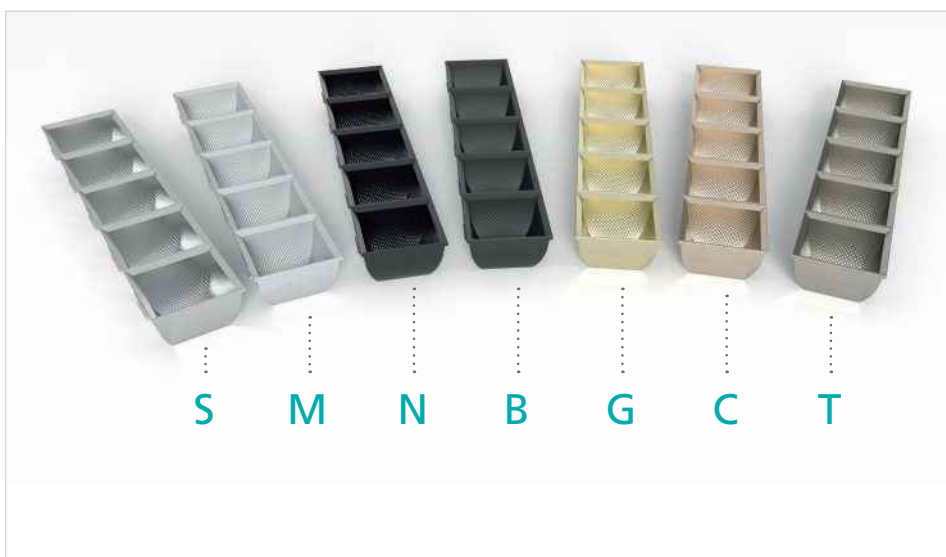
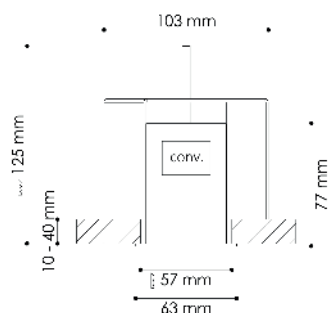

direct

Size [mm]	low output [lm] / [W]	high output [lm] / [W]	 [kg]
498	1.106 / 8,6	2.064 / 16,5	1,6
978	2.212 / 16,7	4.128 / 31,9	2,5
1.218	2.765 / 20,0	5.160 / 39,0	2,9
1.458	3.318 / 23,5	6.192 / 46,0	3,4
1.698	3.871 / 27,0	7.224 / 53,2	4,0
2.178	4.977 / 33,9	9.288 / 67,0	4,9
2.898	6.636 / 43,8	12.384 / 87,9	6,4
3.379	7.742 / 54,0	14.448 / 106,4	7,7



**CUTOUT**

Size [mm]	length [mm]	width [mm]	depth [mm]
498	493	57	125
978	973	57	125
1.218	1.213	57	125
1.458	1.453	57	125
1.698	1.693	57	125
2.178	2.173	57	125
2.898	2.893	57	125
3.379	3.374	57	125

Alle Lumenangaben für 4000K, CRI>80, Reflektor silber hochglanz  
 All lumen values for 4000K, CRI>80, reflector silver specular  
 Toutes les données de lumens pour 4000K, CRI>80, réflecteur argenté brillant



# LINE70

EINBAULEUCHE | RECESSED LUMINAIRE | LUMINAIRE ENCASTRABLE

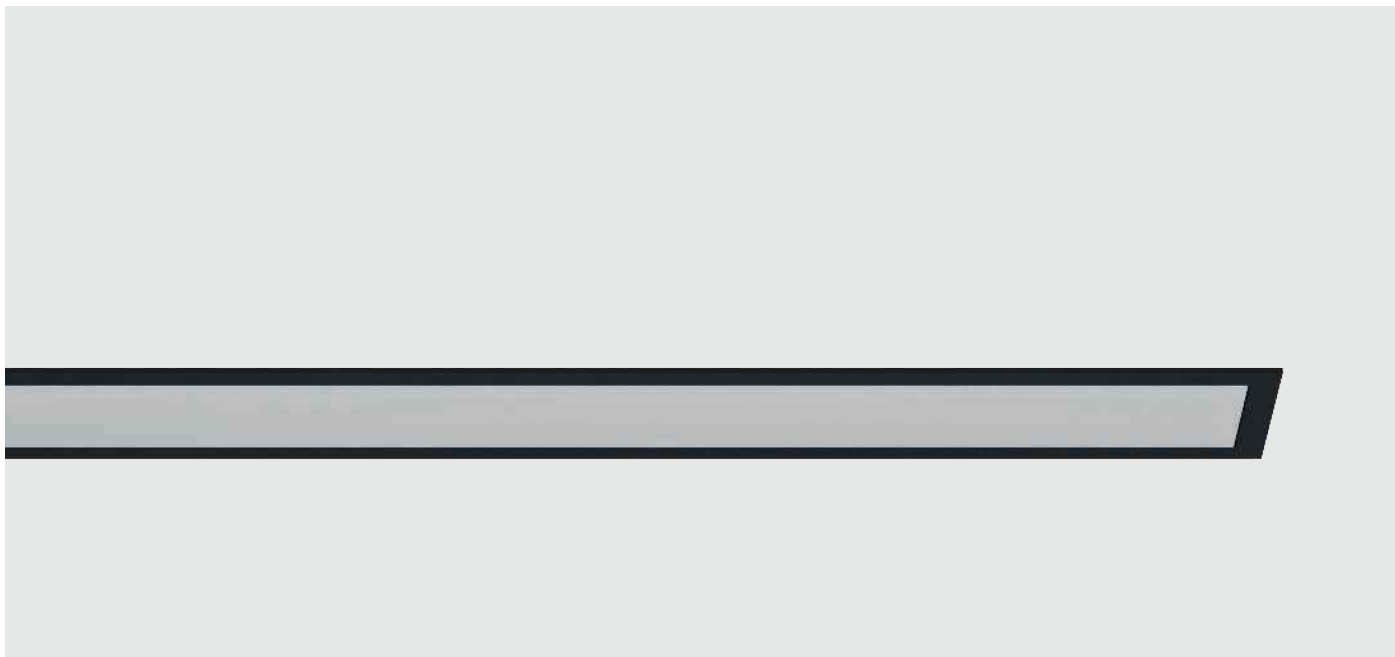

**LED-Einbauleuchte** mit umlaufendem Rahmen direktstrahlend. Lichtkanal aus Aluminium-Strangpressprofil mit einer Gesamtbreite von 88 mm. Fertigung der Leuchtenlänge millimetergenau auf Kundenwunsch möglich. Oberfläche der Leuchte feinstruktur matt pulverbeschichtet ähnlich RAL 9016 weiß, RAL 9006 silber oder RAL 9005 schwarz – auf Anfrage in RAL nach Wahl. Diffusor wahlweise in PMMA opal oder PMMA klar mit eingeschobener mikroprismatischer Platte für eine reduzierte Leuchtdichte (UGR<19). Der LED-Treiber ist im Leuchtengehäuse integriert – wahlweise als on/off oder DALI-Variante. Farbtemperaturen 2700K, 3000K, 4000K oder dynamisch Weiß (2700K–6500K) – Farbwiedergabe CRI>80 oder CRI>90 – Mac Adam ≤3. Weitere Steuerungsoptionen oder Lichtfarben auf Anfrage erhältlich. Außerdem ist die Integration vieler Komponenten, wie beispielsweise Notlicht oder Sensortechnologie, sowie eine Vielzahl weiterer Optionen möglich.

**Recessed LED luminaire** with surrounding frame, direct beam. Light channel made of extruded aluminium profile with a total width of 88 mm. Luminaire length can be manufactured to the exact millimetre on customer request. Surface of the luminaire fine structure matt powder coated similar to RAL 9016 white, RAL 9006 silver or RAL 9005 black - on request in RAL of choice. Diffuser either in PMMA opal or PMMA clear with inserted microprismatic plate for reduced luminance (UGR<19). The LED driver is integrated in the luminaire housing - either as on/off or DALI version. Colour temperatures 2700K, 3000K, 4000K or dynamic white (2700K-6500K) - colour rendering CRI>80 or CRI>90 - Mac Adam ≤3. Further control options or light colours available on request. In addition, the integration of many components, such as emergency lighting or sensor technology, as well as a variety of other options is possible.

**Luminaire de surface LED** encastré avec cadre périphérique à éclairage direct. Canal lumineux en profilé d'aluminium extrudé d'une largeur totale de 88 mm. Fabrication de la longueur du luminaire au millimètre près possible sur demande du client. Surface du luminaire à structure fine, revêtement par poudre mat similaire à RAL 9016 blanc, RAL 9006 argent ou RAL 9005 noir - sur demande en RAL au choix. Diffuseur au choix en PMMA opale ou en PMMA transparente avec plaque microprismatique insérée pour un éblouissement réduit (UGR<19). Le pilote LED est intégré dans le boîtier du luminaire - au choix sous forme de variante on/off ou DALI. Températures de couleur 2700K, 3000K, 4000K ou blanc dynamique (2700K-6500K) - Rendu des couleurs CRI>80 ou CRI>90 - Mac Adam ≤3. Autres options de commande ou couleurs de lumière disponibles sur demande. En outre, l'intégration de nombreux composants, tels que l'éclairage de secours ou la technologie de détection, une multitude d'autres options sont possibles.

## ÜBERSICHT | OVERVIEW | VUE D'ENSEMBLE

### TECHNICAL DATA

2700K / 3000K / 4000K / 2700-6500K

CRI>80 / CRI>90

MacAdam ≤ 3

up to 125 lm/W, up to 2.836 lm/m

on-off / DALI

direct

opal / microprism (UGR <19)

L80 B10 50.000h

### HOUSING COLOUR

schwarz | black | noir  
RAL 9005

silber | silver | argent  
RAL 9006

weiß | white | blanc  
RAL 9016



RAL colour of your choice



Integration of Multisensor



Welded mitre cuts



Integration of emergency light



Contact us for more options...

**EINBAULEUCHE „LINE70“**  
**RECESSED LUMINAIRE “LINE70”**  
**LUMINAIRE ENCASTRABLE « LINE70 »**

Bestellbeispiel | Example order | Exemple de commande  
 3.152 mm, CRI>90, 4000K, **direct**, low output on/off, black, microprism

**LI70E-319401-LOBLM**

1 2 3 4 5 6

**1 LÄNGE**  
**LENGTH**  
**LONGUEUR**

632 mm	<b>06</b>
992 mm	<b>09</b>
1.232 mm	<b>12</b>
1.472 mm	<b>14</b>
1.712 mm	<b>17</b>
1.952 mm	<b>19</b>
2.192 mm	<b>21</b>
2.432 mm	<b>24</b>
2.912 mm	<b>29</b>
3.152 mm	<b>31</b>
3.874 mm	<b>38</b>

**2 FARBWIEDERGABE**  
**COLOUR RENDERING**  
**RENDU DES COULEURS**

CRI>80	<b>8</b>
CRI>90	<b>9</b>

**3 FARBTEMPERATUR**  
**COLOUR TEMPERATURE**  
**TEMPÉRATURE DE COULEUR**

2700K (CRI>90 only)	<b>27</b>
3000K	<b>30</b>
4000K	<b>40</b>
2700-6500K (CRI>90 only)	<b>DW</b>

**4 LEISTUNG & STEUERUNG**  
**OUTPUT & CONTROL**  
**SORTIE & CONTRÔLE**

low output on/off	<b>LO</b>
low output DALI	<b>LD</b>
high output on/off	<b>HO</b>
high output DALI	<b>HD</b>
dynamic white DALI DT8	<b>DW</b>

**5 GEHÄUSEFARBE**  
**HOUSING COLOUR**  
**COULEUR DU BOÎTIER**

silver RAL 9006	<b>SI</b>
white RAL 9016	<b>WH</b>
black RAL 9005	<b>BL</b>

**6 DIFFUSOR**  
**DIFFUSER**  
**DIFFUSEUR**

opal	<b>O</b>
microprism	<b>M</b>

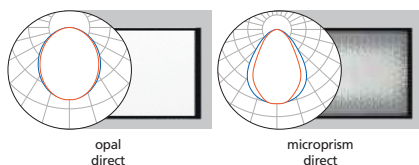
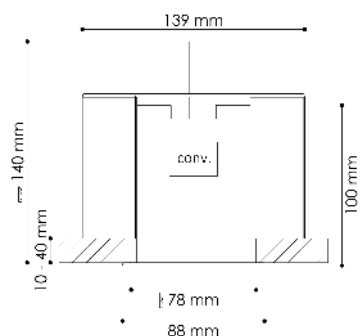

Size [mm]	low output		high output		
	[lm] / [W]	[lm] / [W]	[lm] / [W]	[lm] / [W]	
632	1.077 / 11,8	1.709 / 16,3	1.045 / 11,8	1.608 / 16,3	2,5
992	1.723 / 15,2	2.734 / 25,0	1.672 / 15,2	2.573 / 25,0	3,4
1.232	2.154 / 18,8	3.418 / 30,0	2.090 / 18,8	3.216 / 30,0	3,9
1.472	2.585 / 22,1	4.102 / 35,8	2.508 / 22,1	3.859 / 35,8	4,5
1.712	3.016 / 25,5	4.785 / 41,1	2.926 / 25,5	4.502 / 41,1	5,2
1.952	3.446 / 28,7	5.469 / 46,3	3.344 / 28,7	5.146 / 46,3	5,8
2.192	3.877 / 32,0	6.152 / 52,0	3.762 / 32,0	5.789 / 52,0	6,6
2.432	4.308 / 35,4	6.836 / 57,3	4.180 / 35,4	6.432 / 57,3	7,2
2.912	5.170 / 41,6	8.203 / 69,6	5.016 / 41,6	7.718 / 69,6	8,5
3.152	5.600 / 44,8	8.887 / 75,5	5.434 / 44,8	8.362 / 75,5	9,2
3.874	6.892 / 57,4	10.938 / 92,6	6.688 / 57,4	10.292 / 92,6	11,4



**CUTOUT**

Size [mm]	length [mm]	width [mm]	depth [mm]
632	624	78	140
992	984	78	140
1.232	1.224	78	140
1.472	1.464	78	140
1.712	1.704	78	140
1.952	1.944	78	140
2.192	2.184	78	140
2.432	2.424	78	140
2.912	2.904	78	140
3.152	3.144	78	140
3.874	3.866	78	140

Alle Lumenangaben für 4000K, CRI>80, Microprisma ohne Opalfolie  
 All lumen values for 4000K, CRI>80, microprism without opal foil  
 Toutes les données de lumens pour 4000K, CRI>80, microprisme sans feuille opale

# RING50

EINBAULEUCHE | RECESSED LUMINAIRE | LUMINAIRE ENCASTRABLE

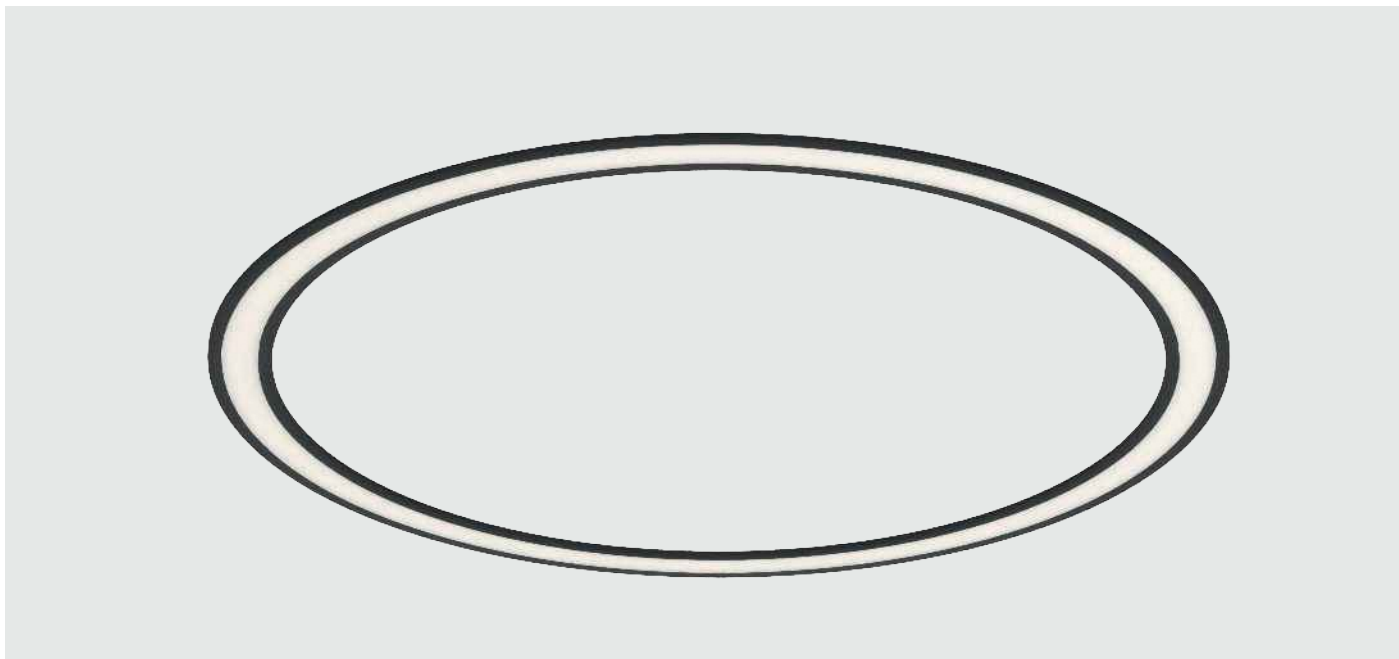

Ringförmige LED-Einbauleuchte mit umlaufendem Rahmen, direktstrahlend. Lichtkanal aus gerolltem Aluminiumprofil mit einer Gesamtbreite von 63 mm. Leuchte erhältlich in neun verschiedenen Durchmessern – 1233 und 1588 mm in einem Stück nahtlos verschweißt – die restlichen Größen (2033, 2608, 3103, 3548, 4083, 5063, 6088 mm) bestehend aus zwei bis neun gleich großen Segmenten. Oberfläche der Leuchte feinstruktur matt pulverbeschichtet ähnlich RAL 9016 weiß, RAL 9006 silber oder RAL 9005 schwarz – auf Anfrage in RAL nach Wahl. Diffusor wahlweise in PMMA opal oder PMMA klar mit mikroprismatischer Prägung für eine reduzierte Leuchtdichte (UGR<19). Der LED-Treiber ist im Leuchtgehäuse integriert – wahlweise als on/off oder DALI-Variante. Farbtemperaturen 2700K, 3000K, 4000K oder dynamisch Weiß (2700K–6500K) – Farbwiedergabe CRI>80 oder CRI>90 – Mac Adam ≤3. Weitere Steuerungsoptionen oder Lichtfarben auf Anfrage erhältlich. Außerdem ist die Integration vieler Komponenten, wie beispielsweise Notlicht oder Sensortechnologie, sowie eine Vielzahl weiterer Optionen möglich.

Ring-shaped recessed LED luminaire with surrounding frame, direct beam. Light channel made of rolled aluminium profile with a total width of 63 mm. Luminaire available in nine different diameters - 1233 and 1588 mm seamlessly welded in one piece - the remaining sizes (2033, 2608, 3103, 3548, 4083, 5063, 6088 mm) consisting of two to nine equally sized segments. Surface of the luminaire fine structure matt powder coated similar to RAL 9016 white, RAL 9006 silver or RAL 9005 black - on request in RAL of choice. Diffuser either in PMMA opal or PMMA clear with microprismatic pattern for reduced luminance (UGR<19). The LED driver is integrated in the luminaire housing - either as on/off or DALI version. Colour temperatures 2700K, 3000K, 4000K or dynamic white (2700K-6500K) - colour rendering CRI>80 or CRI>90 - Mac Adam ≤3. Further control options or light colours available on request. In addition, the integration of many components, such as emergency lighting or sensor technology, as well as a variety of other options is possible.

Luminaire LED encastré en forme d'anneau avec cadre périphérique, éclairage direct. Canal lumineux en profilé d'aluminium roulé d'une largeur totale de 63 mm. Luminaire disponible en neuf diamètres différents - 1233 et 1588 mm en une seule pièce soudée sans soudure - les autres tailles (2033, 2608, 3103, 3548, 4083, 5063, 6088 mm) se composent de deux à neuf segments de même taille. Surface du luminaire à structure fine matte revêtue par poudre similaire à RAL 9016 blanc, RAL 9006 argent ou RAL 9005 noir - sur demande en RAL au choix. Diffuseur au choix en PMMA opale ou en PMMA transparent avec gaufrage microprismatique pour un éblouissement réduit (UGR<19). Le driver LED est intégré dans le boîtier du luminaire - au choix en version on/off ou DALI. Températures de couleur 2700K, 3000K, 4000K ou blanc dynamique (2700K-6500K) - Rendu des couleurs CRI>80 ou CRI>90 - Mac Adam ≤3. Autres options de commande ou couleurs de lumière disponibles sur demande. En outre, l'intégration de nombreux composants, tels que l'éclairage de secours ou la technologie des capteurs, une multitude d'autres options sont possibles.

## ÜBERSICHT | OVERVIEW | VUE D'ENSEMBLE

### TECHNICAL DATA

2700K / 3000K / 4000K / 2700-6500K

CRI>80 / CRI>90

MacAdam ≤ 3

up to 131 lm/W

on-off / DALI

direct

opal / microprism (UGR <19)

L80 B10 50.000h

### HOUSING COLOUR

schwarz | black | noir  
RAL 9005

silber | silver | argent  
RAL 9006

weiß | white | blanc  
RAL 9016



RAL colour of your choice



Integration of emergency light



Contact us for more options...

**EINBAULEUCHE „RING50“**  
**RECESSED LUMINAIRE “RING50”**  
**LUMINAIRE ENCASTRABLE « RING50 »**

Bestellbeispiel | Example order | Exemple de commande  
 6.088 mm, CRI>90, 4000K, **direct**, low output on/off, black, microprism

**RG50E-609401-LOBLM**

1 2 3 4 5 6

**1 DURCHMESSER**  
**DIFFUSER**  
**DIFFUSEUR**

1.233 mm (no DW)	<b>12</b>
1.588 mm (no DW)	<b>15</b>
2.033 mm	<b>20</b>
2.608 mm	<b>26</b>
3.103 mm	<b>31</b>
3.548 mm	<b>35</b>
4.083 mm	<b>40</b>
5.063 mm	<b>50</b>
6.088 mm	<b>60</b>

**2 FARBWIEDERGABE**  
**COLOUR RENDERING**  
**RENDU DES COULEURS**

CRI>80	<b>8</b>
CRI>90	<b>9</b>

**3 FARBTEMPERATUR**  
**COLOUR TEMPERATURE**  
**TEMPÉRATURE DE COULEUR**

2700K (CRI>90 only)	<b>27</b>
3000K	<b>30</b>
4000K	<b>40</b>
2700-6500K (CRI>90 only)	<b>DW</b>

**4 LEISTUNG & STEUERUNG**  
**OUTPUT & CONTROL**  
**SORTIE & CONTRÔLE**

low output on/off	<b>LO</b>
low output DALI	<b>LD</b>
high output on/off	<b>HO</b>
high output DALI	<b>HD</b>
dynamic white DALI DT8	<b>DW</b>

**5 GEHÄUSEFARBE**  
**HOUSING COLOUR**  
**COULEUR DU BOÎTIER**

silver RAL 9006	<b>SI</b>
white RAL 9016	<b>WH</b>
black RAL 9005	<b>BL</b>

**6 DIFFUSOR**  
**DIFFUSER**  
**DIFFUSEUR**

opal	<b>O</b>
microprism	<b>M</b>

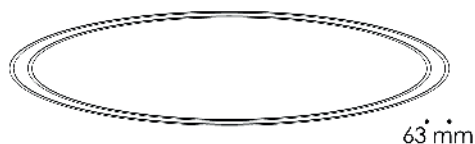

Ø 1233 / 1588 / 2033 / 2608 / 3103 /  
 3548 / 4083 / 5063 / 6088 mm

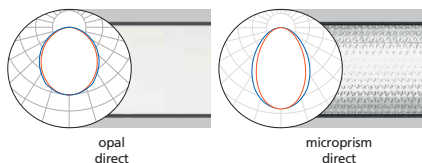
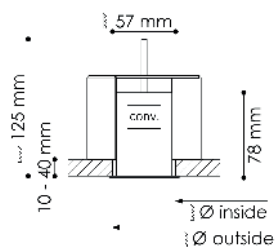

**CUTOUT**

Size [mm]	low output [lm] / [W]	high output [lm] / [W]	low output [lm] / [W]	high output [lm] / [W]	 [kg]
Ø 1.233	4.888 / 38,3	8.376 / 66,3	5.026 / 38,3	8.616 / 66,3	10,3
Ø 1.588	6.110 / 51,2	10.470 / 86,6	6.283 / 51,2	10.770 / 86,6	13,3
Ø 2.033	7.943 / 65,0	13.611 / 113,2	8.168 / 65,0	14.001 / 113,2	17,0
Ø 2.608	10.387 / 85,0	17.799 / 147,9	10.681 / 85,0	18.309 / 147,9	21,9
Ø 3.103	12.220 / 102,4	20.940 / 178,0	12.566 / 102,4	21.540 / 178,0	26,1
Ø 3.548	14.053 / 120,7	24.081 / 209,0	14.451 / 120,7	24.771 / 209,0	29,8
Ø 4.083	15.886 / 137,0	27.222 / 238,0	16.336 / 137,0	28.002 / 238,0	34,3
Ø 5.063	20.163 / 172,0	34.551 / 298,0	20.734 / 172,0	35.541 / 298,0	42,6
Ø 6.088	23.829 / 205,5	40.833 / 357,0	24.504 / 205,5	42.003 / 357,0	51,3

Size [mm]	inside [mm]	outside [mm]	depth [mm]
Ø 1.233	Ø 1.113	Ø 1.227	125
Ø 1.588	Ø 1.468	Ø 1.582	125
Ø 2.033	Ø 1.913	Ø 2.027	125
Ø 2.608	Ø 2.488	Ø 2.602	125
Ø 3.103	Ø 2.983	Ø 3.097	125
Ø 3.548	Ø 3.428	Ø 3.542	125
Ø 4.083	Ø 3.963	Ø 4.077	125
Ø 5.063	Ø 4.943	Ø 5.057	125
Ø 6.088	Ø 5.968	Ø 6.082	125

Alle Lumenangaben für 4000K, CRI>80, Gehäusefarbe weiß  
 All lumen values for 4000K, CRI>80, housing colour white  
 Toutes les données de lumens pour 4000K, CRI>80, couleur du boîtier blanc

# FLEX50

EINBAULEUCHE | RECESSED LUMINAIRE | LUMINAIRE ENCASTRABLE

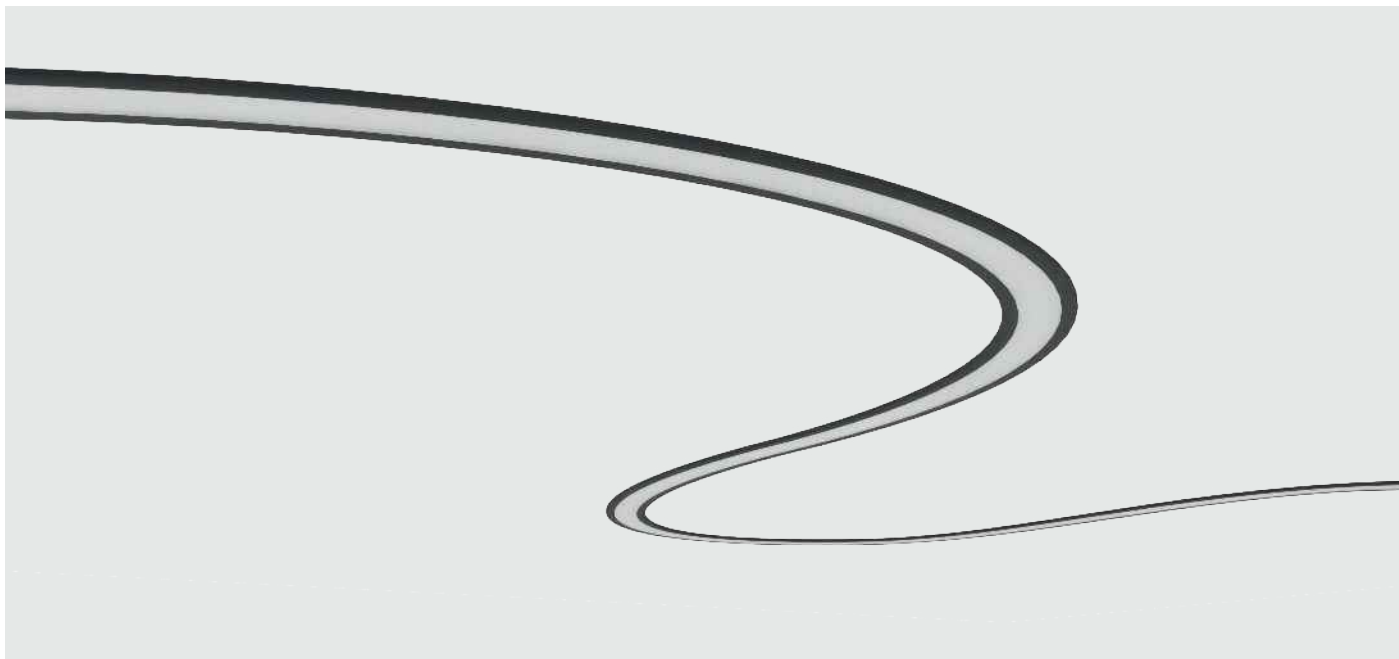

**LED-Einbauleuchte als Segment** zur individuellen Kombination. Direktstrahlend. Lichtkanal aus gerolltem Aluminiumprofil mit einer Breite von 63 mm. Segmente erhältlich in 13 verschiedenen Varianten – zwei Stück als gerades Profil 980 oder 1960 mm – die restlichen Segmente sind als 40°, 45°, 60°- bzw. 90°-Stücke mit einem Mittenradius von 585 bis 3012,5 mm erhältlich. Oberfläche der Leuchte feinstruktur matt pulverbeschichtet ähnlich RAL 9016 weiß, RAL 9006 silber oder RAL 9005 schwarz – auf Anfrage in RAL nach Wahl. Diffusor wahlweise in PMMA opal oder PMMA mit mikroprismatischer Prägung für eine reduzierte Leuchtdichte (UGR<19). Der LED-Treiber ist im Leuchtgehäuse integriert – wahlweise als on/off oder DALI-Variante. Farbtemperaturen 2700K, 3000K, 4000K oder dynamisch Weiß (2700K–6500K) – Farbwiedergabe CRI>80 oder CRI>90 – Mac Adam ≤3. Weitere Steuerungsoptionen oder Lichtfarben auf Anfrage erhältlich. Außerdem ist die Integration vieler Komponenten, wie beispielsweise Notlicht oder Sensortechnologie, sowie eine Vielzahl weiterer Optionen möglich.

**Recessed LED luminaire as segment** for individual combination. Direct beam. Light channel made of rolled aluminium profile with a width of 63 mm. Segments available in 13 different versions - two pieces as straight profile 980 or 1960 mm - the remaining segments are available as 40°, 45°, 60° or 90° pieces with a middle radius of 585 to 3012.5 mm. Surface of the luminaire fine structure matt powder coated similar to RAL 9016 white, RAL 9006 silver or RAL 9005 black - on request in RAL of choice. Diffuser either in PMMA opal or PMMA clear with microprismatic pattern for reduced luminance (UGR<19). The LED driver is integrated in the luminaire housing - either as on/off or DALI version. Colour temperatures 2700K, 3000K, 4000K or dynamic white (2700K-6500K) - colour rendering CRI>80 or CRI>90 - Mac Adam ≤3. Further control options or light colours available on request. In addition, the integration of many components, such as emergency lighting or sensor technology, as well as a variety of other options is possible.

**Luminaire LED encastré a segment** pour une combinaison individuelle. Éclairage direct de la surface. Canal lumineux en profilé d'aluminium roulé d'une largeur de 63 mm. Segments disponibles en 13 variantes différentes - deux pièces sous forme de profilé droit de 980 ou 1960 mm - les autres segments sont disponibles sous forme de pièces de 40°, 45°, 60° ou 90° avec un rayon central de 585 à 3012,5 mm. Surface du luminaire à structure fine matte revêtue par poudre similaire à RAL 9016 blanc, RAL 9006 argent ou RAL 9005 noir - sur demande en RAL au choix. Diffuseur au choix en PMMA opale ou en PMMA transparent avec gaufrage microprismatique pour un éblouissement réduit (UGR<19). Le pilote LED est intégré dans le boîtier du luminaire - au choix sous forme de variante on/off ou DALI. Températures de couleur 2700K, 3000K, 4000K ou blanc dynamique (2700K-6500K) - Rendu des couleurs CRI>80 ou CRI>90 - Mac Adam ≤3. Autres options de commande ou couleurs de lumière disponibles sur demande. En outre, l'intégration de nombreux composants, tels que l'éclairage de secours ou la technologie de détection, une multitude d'autres options sont possibles.

## ÜBERSICHT | OVERVIEW | VUE D'ENSEMBLE

### TECHNICAL DATA

2700K / 3000K / 4000K / 2700-6500K

CRI>80 / CRI>90

MacAdam ≤ 3

up to 119 lm/W

on-off / DALI

direct

opal / microprism (UGR <19)

L80 B10 50.000h

### HOUSING COLOUR

schwarz | black | noir  
RAL 9005

silber | silver | argent  
RAL 9006

weiß | white | blanc  
RAL 9016



RAL colour of your choice



Integration of emergency light



Contact us for more options...

**EINBAULEUCHE „FLEX50“**  
**RECESSED LUMINAIRE “FLEX50”**  
**LUMINAIRE ENCASTRABLE « FLEX50 »**

Bestellbeispiel | Example order | Exemple de commande  
 straight, 1.960 mm, CRI>90, 4000K, **direct**, low output on/off, black, microprism

**FX50E-L29401-LOBLM**

1 2 3 4 5 6

1 GRÖSSE SIZE TAILLE	
straight, L 980 mm	<b>L1</b>
straight, L 1.960 mm	<b>L2</b>
90°, R 585 mm (no DW)	<b>19</b>
90°, R 762,5 mm (no DW)	<b>29</b>
90°, R 985 mm	<b>39</b>
45°, R 1.272,5 mm	<b>44</b>
90°, R 1.272,5 mm	<b>49</b>
60°, R 1.520 mm	<b>56</b>
90°, R 1.520 mm	<b>59</b>
60°, R 1.742,5 mm	<b>66</b>
60°, R 2.010 mm	<b>76</b>
45°, R 2.500 mm	<b>84</b>
40°, R 3.012,5 mm	<b>94</b>

2 FARBWIEDERGABE COLOUR RENDERING RENDU DES COULEURS	
CRI>80	<b>8</b>
CRI>90	<b>9</b>

3 FARBTEMPERATUR COLOUR TEMPERATURE TEMPÉRATURE DE COULEUR	
2700K (CRI>90 only)	<b>27</b>
3000K	<b>30</b>
4000K	<b>40</b>
2700-6500K (CRI>90 only)	<b>DW</b>

4 LEISTUNG & STEUERUNG OUTPUT & CONTROL SORTIE & CONTRÔLE	
low output on/off	<b>LO</b>
low output DALI	<b>LD</b>
high output on/off	<b>HO</b>
high output DALI	<b>HD</b>
dynamic white DALI DT8	<b>DW</b>

5 GEHÄUSEFARBE HOUSING COLOUR COULEUR DU BOÎTIER	
silver RAL 9006	<b>SI</b>
white RAL 9016	<b>WH</b>
black RAL 9005	<b>BL</b>

6 DIFFUSOR DIFFUSER DIFFUSEUR	
opal	<b>O</b>
microprism	<b>M</b>

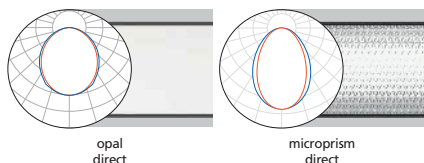
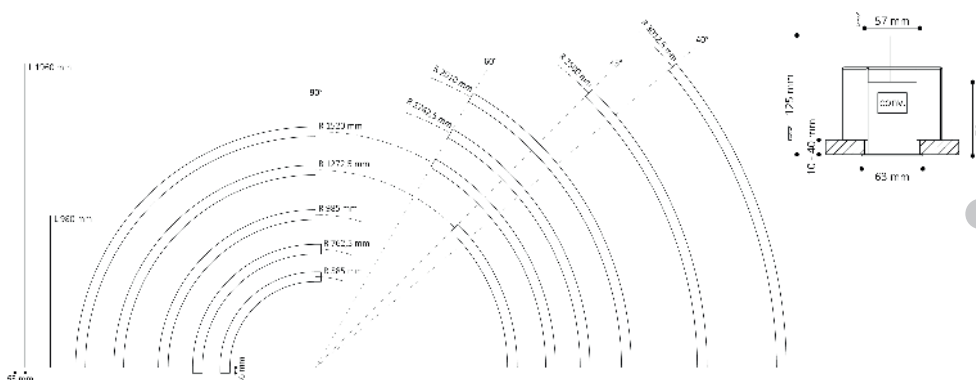

Size [mm]	opal direct		microprism direct		kg
	low output [lm] / [W]	high output [lm] / [W]	low output [lm] / [W]	high output [lm] / [W]	
straight, L 980	1.222 / 11,2	2.094 / 18,1	1.257 / 11,2	2.153 / 18,1	2,6
straight, L 1.960	2.554 / 23,3	4.377 / 37,8	2.626 / 23,3	4.377 / 37,8	5,3
90°, R 585	1.224 / 9,6	2.096 / 16,6	1.256 / 9,6	2.156 / 16,6	2,6
90°, R 762,5	1.530 / 12,8	2.620 / 21,6	1.570 / 12,8	2.695 / 21,6	3,3
90°, R 985	1.836 / 16,3	3.144 / 28,3	1.884 / 16,3	3.234 / 28,3	4,3
45°, R 1.272,5	1.224 / 10,6	2.096 / 18,5	1.256 / 10,6	2.156 / 18,5	2,7
90°, R 1.272,5	2.448 / 21,3	4.192 / 37,0	2.512 / 21,3	4.312 / 37,0	5,5
60°, R 1.520	1.836 / 17,1	3.144 / 29,6	1.884 / 17,1	3.234 / 29,6	4,3
90°, R 1.520	3.060 / 25,6	5.240 / 44,5	3.140 / 25,6	5.390 / 44,5	6,5
60°, R 1.742,5	2.142 / 20,1	3.668 / 34,8	2.198 / 20,1	3.773 / 34,8	5,0
60°, R 2.010	2.754 / 22,8	4.716 / 39,7	2.826 / 22,8	4.851 / 39,7	5,7
45°, R 2.500	2.448 / 21,5	4.192 / 37,2	2.512 / 21,5	4.312 / 37,2	5,3
40°, R 3.012,5	2.754 / 22,8	4.716 / 39,7	2.826 / 22,8	4.851 / 39,7	5,7

**ACCESSORIES**

**END CAPS - 2 pcs.**

black	<b>FX50E-EC-BL</b>
silver	<b>FX50E-EC-SI</b>
white	<b>FX50E-EC-WH</b>



**CUTOUT**

Size [mm]	width [mm]	depth [mm]
	57	125

Alle Lumenangaben für 4000K, CRI>80, Gehäusefarbe weiß

All lumen values for 4000K, CRI>80, housing colour white

Toutes les données de lumens pour 4000K, CRI>80, couleur du boîtier blanc



# ROUND90

Einbauleuchte | Recessed luminaire | Luminaire encastrable



**Runde LED-Flächenleuchte zur Einbaumontage.** Direktstrahlend mit umlaufendem Rahmen. Gehäuse und Einbaurahmen aus gerolltem Aluminiumprofil, nahtlos verschweißt. Fertigung der Leuchte inkl. Rahmen in vier Durchmessern: 380, 480, 680 und 980 mm mit einer Gesamthöhe von 93 mm. Benötigte Einbauhöhe 120mm. Oberfläche pulverbeschichtet feinststruktur matt ähnlich RAL 9016 weiß, RAL 9006 silber oder RAL 9005 schwarz – auf Anfrage in RAL nach Wahl. Die durchdachte Konstruktion der Leuchte ermöglicht ein Design in zahlreichen Farbkombinationen – zwischen Gehäusefarbe und Dekorring kann beliebig kombiniert werden. Um der Leuchtenfamilie neben den Standardfarben einen dekorativen Touch zu verleihen, steht der Dekorring auch in den strukturierten Spezialoberflächen schlaggold, schlagsilber und schlagbronze zur Auswahl. Diffusor in PMMA wahlweise opal, mikroprismatisch inkl. Streufole oder nur mikroprismatisch (office special) für eine reduzierte Leuchtdichte (UGR<19). Einfache Montage der Leuchte in den Einbaurahmen (separate Einheit) durch Einsetzen und Drehen. Der LED-Treiber wird als Einwurf-Gerät inkl. Zugentlastung mitgeliefert – wahlweise als on/off oder DALI-Variante. Farbtemperaturen 2700K, 3000K, 4000K oder dynamisch Weiß (2700K–6500K) – Farbwiedergabe CRI>80 oder CRI>90 – Mac Adam ≤3. Weitere Steuerungsoptionen oder Lichtfarben auf Anfrage möglich. Außerdem ist die Integration vieler Komponenten, wie beispielsweise Notlicht oder Sensortechnologie, sowie eine Vielzahl weiterer Optionen möglich.

**Round LED luminaire for recessed mounting.** Direct beam with surrounding frame. Housing and mounting frame made of rolled aluminium profile, seamlessly welded. Manufacture of luminaire incl. frame in four diameters: 380, 480, 680 and 980 mm with a total height of 93 mm. Required installation height 120mm. Surface powder coated fine structure matt similar to RAL 9016 white, RAL 9006 silver or RAL 9005 black - on request in RAL of your choice. The sophisticated construction of the luminaire allows a design in numerous colour combinations - any combination of housing colour and decorative ring is possible. To give the luminaire family a decorative touch in addition to the standard colours, the decorative ring is also available in the special textured surfaces beaten gold, beaten silver and beaten bronze. Diffuser in PMMA either opal, microprism incl. diffuser foil or only microprism (office special) for reduced luminance (UGR<19). Easy mounting of the luminaire in the mounting frame (separate unit) by inserting and turning. The LED driver is supplied as a throw-in unit incl. strain relief - either as on/off or DALI version. Colour temperatures 2700K, 3000K, 4000K or dynamic white (2700K-6500K) - colour rendering CRI>80 or CRI>90 - Mac Adam ≤3. Further control options or light colours available on request. In addition, the integration of many components, such as emergency lighting or sensor technology, as well as a variety of other options is possible.

**Luminaire rond LED encastré.** Éclairage direct avec cadre périphérique. Boîtier et cadre d'encastrement en profilé d'aluminium roulé, soudé sans soudure. Fabrication du luminaire, cadre inclus, en quatre diamètres : 380, 480, 680 et 980 mm avec une hauteur totale de 93 mm. Hauteur d'encastrement nécessaire : 120 mm. Surface revêtue par poudre, structure fine mate similaire à RAL 9016 blanc, RAL 9006 argent ou RAL 9005 noir - sur demande en RAL au choix. La construction bien pensée du luminaire permet un design dans de nombreuses combinaisons de couleurs - il est possible de combiner à volonté entre la couleur du boîtier et l'anneau décoratif. Pour donner à la famille de luminaires une touche décorative en plus des couleurs standard, l'anneau décoratif est également disponible dans les surfaces spéciales structurées or choc, argent choc et bronze choc. Diffuseur en PMMA au choix opale, microprismatique y compris feuille diffuseuse ou uniquement microprismatique (office special) pour un éblouissement réduit (UGR<19). Montage simple du luminaire dans le cadre d'encastrement (unité séparée) en l'insérant et en le tournant. Le driver LED est fourni sous forme d'appareil à insérer, décharge de traction incluse - au choix en version on/off ou DALI. Températures de couleur 2700K, 3000K, 4000K ou blanc dynamique (2700K-6500K) - Rendu des couleurs CRI>80 ou CRI>90 - Mac Adam ≤3. Autres options de commande ou couleurs de lumière possibles sur demande. En outre, l'intégration de nombreux composants, tels que l'éclairage de secours ou la technologie des capteurs, une multitude d'autres options sont possibles.

## ÜBERSICHT | OVERVIEW | VUE D'ENSEMBLE

### TECHNICAL DATA

2700K / 3000K / 4000K / 2700-6500K

CRI>80 / CRI>90

MacAdam ≤ 3

up to 174 lm/W

on-off / DALI

direct / direct + indirect

opal / microprism / office special (UGR <19)

L80 B10 50.000h



RAL colour of your choice



Integration of Multisensor



Integration of emergency light



Contact us for more options...

### HOUSING COLOUR

schwarz | black | noir  
RAL 9005



silber | silver | argent  
RAL 9006



weiß | white | blanc  
RAL 9016



### DECORATION RING COLOUR

schwarz | black | noir  
RAL 9005



schlaggold | beaten gold | or texturés



silber | silver | argent  
RAL 9006



schlagsilber | beaten silver | argent texturés



weiß | white | blanc  
RAL 9016



schlagbronze | beaten bronze | bronze texturés



**EINBAULEUCHE „ROUND90“**  
 RECESSED LUMINAIRE "ROUND90"  
 LUMINAIRE ENCASTRABLE « ROUND90 »

Bestellbeispiel | Example order | Exemple de commande  
 380 mm, CRI>90, 4000K, **direct**, low output on/off, black, beaten gold, microprism

**RO90E-359401-LOBGM**

1 2 3 4 5 6 7

<b>1</b>	<b>DURCHMESSER</b> DIAMETER DIAMÈTRE	
	380 mm	<b>35</b>
	480 mm	<b>45</b>
	680 mm	<b>65</b>
	980 mm	<b>95</b>
<b>2</b>	<b>FARBWIEDERGABE</b> COLOUR RENDERING RENDU DES COULEURS	
	CRI>80	<b>8</b>
	CRI>90	<b>9</b>
<b>3</b>	<b>FARBTEMPERATUR</b> COLOUR TEMPERATURE TEMPÉRATURE DE COULEUR	
	2700K (CRI>90 only)	<b>27</b>
	3000K	<b>30</b>
	4000K	<b>40</b>
	2700-6500K (CRI>90 only)	<b>DW</b>

<b>4</b>	<b>LEISTUNG &amp; STEUERUNG</b> OUTPUT & CONTROL SORTIE & CONTRÔLE	
	low output on/off	<b>LO</b>
	low output DALI	<b>LD</b>
	high output on/off	<b>HO</b>
	high output DALI	<b>HD</b>
	dynamic white DALI DT8	<b>DW</b>

<b>5</b>	<b>GEHÄUSEFARBE</b> HOUSING COLOUR COULEUR DU BOÎTIER	
	black RAL 9005	<b>B</b>
	silver RAL 9006	<b>S</b>
	white RAL 9016	<b>W</b>

<b>6</b>	<b>DEKORRING FARBE</b> DECORATION RING COLOUR BAGUE DÉCORATIVE COULEUR	
	black RAL 9005	<b>B</b>
	silver RAL 9006	<b>S</b>
	white RAL 9016	<b>W</b>
	beaten gold	<b>G</b>
	beaten silver	<b>A</b>
	beaten bronze	<b>C</b>

<b>7</b>	<b>DIFFUSOR</b> DIFFUSER DIFFUSEUR	
	opal	<b>O</b>
	microprism	<b>M</b>
	office special	<b>B</b>

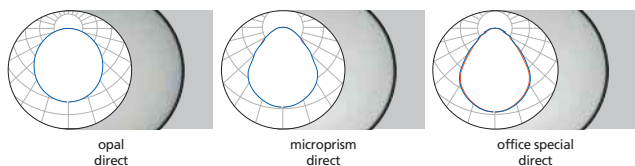
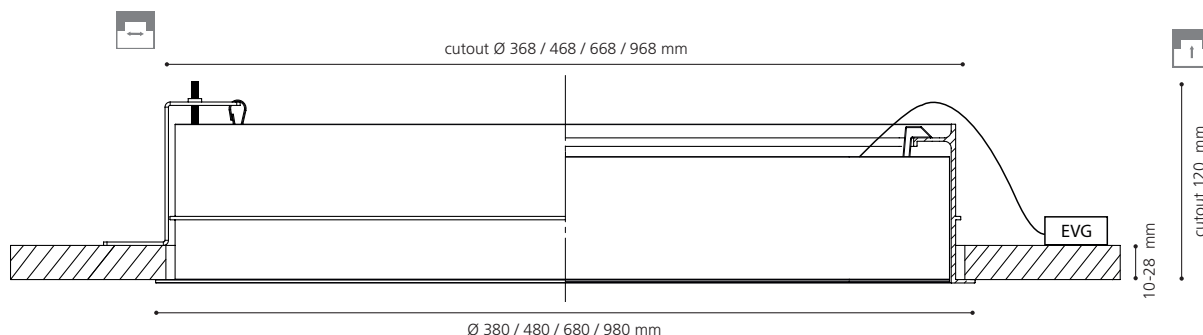

Size [mm]	low output [lm] / [W]	high output [lm] / [W]	low output [lm] / [W]	high output [lm] / [W]	low output [lm] / [W]	high output [lm] / [W]	KG
Ø 380	1.158 / 8,5	1.826 / 12,9	1.077 / 8,5	1.697 / 12,9	1.213 / 8,5	1.905 / 12,9	3,7
Ø 480	2.258 / 15,5	3.561 / 23,5	2.099 / 15,5	3.309 / 23,5	2.364 / 15,5	3.715 / 23,5	5,2
Ø 680	4.114 / 27,2	6.489 / 41,3	3.825 / 27,2	6.029 / 41,3	4.309 / 27,2	6.770 / 41,3	8,9
Ø 980	9.102 / 56,7	14.360 / 86,0	8.466 / 56,7	13.342 / 86,0	9.535 / 56,7	14.982 / 86,0	15,5



**CUTOUT**

Size [mm]	diameter [mm]	depth [mm]
Ø 380	Ø 368	120
Ø 480	Ø 468	120
Ø 680	Ø 668	120
Ø 980	Ø 968	120

Alle Lumenangaben für 4000K, CRI>80, Gehäusefarbe weiß  
 All lumen values for 4000K, CRI>80, housing colour white  
 Toutes les données de lumens pour 4000K, CRI>80, couleur du boîtier blanc

# DOWN75

Einbauleuchte | Recessed Luminaire | Luminaire Encastrable



Runder und quadratischer LED-Einbaustrahler direktstrahlend in der Größe Ø75mm bzw 75mm x 75mm für den Deckenausschnitt von Ø65mm. Leuchte aus Aluminium-Druckguss. Oberfläche der Leuchte feinstruktur matt pulverbeschichtet ähnlich RAL 9016 weiß, ähnlich RAL 9005 schwarz oder ähnlich RAL 9006. Leistungsstarke Downlightserie mit zwei verschiedenen Leistungsstufen - low Output (Einbautiefe: 80mm) oder high Output (Einbautiefe: 100mm). Zwei verschiedene Abstrahlcharakteristiken mit 23° und 45° wählbar. Die Leuchte ist inkl. LED-Treiber – on/off, TRIAC oder DALI – bestellbar. Farbtemperaturen 2700K, 3000K oder 4000K – Farbwiedergabe CRI>90 – Mac Adam ≤3. Weitere Optionen und Konfigurationen auf Anfrage möglich.

Round and square LED recessed downlight with direct beam in the size Ø75mm or 75mm x 75mm for the ceiling cut-out of Ø65mm. Luminaire made of die-cast aluminum. Surface of the luminaire fine structure matt powder-coated similar to RAL 9016 white, similar to RAL 9005 black or similar to RAL 9006. Powerful downlight series with two different output levels - low output (installation depth: 80mm) or high output (installation depth: 100mm). Two different beam characteristics with 23° and 45° selectable. The luminaire can be ordered including LED driver - on/off, TRIAC or DALI. Color temperatures 2700K, 3000K or 4000K - color rendering CRI>90 - Mac Adam ≤3. Further options and configurations available on request.

Spot LED encastré rond et carré à émission directe de Ø75mm ou 75mm x 75mm pour une découpe de plafond de Ø65mm. Luminaire en aluminium moulé sous pression. Surface du luminaire revêtue de poudre à structure fine mate similaire à RAL 9016 blanc, similaire à RAL 9005 noir ou similaire à RAL 9006. Série de downlights puissants avec deux niveaux de puissance différents - low output (profondeur d'encastrement : 80mm) ou high output (profondeur d'encastrement : 100mm). Deux caractéristiques de rayonnement différentes avec 23° et 45° au choix. Le luminaire peut être commandé avec un pilote LED - on/off, TRIAC ou DALI. Températures de couleur 2700K, 3000K ou 4000K - Rendu des couleurs CRI>90 - Mac Adam ≤3. Autres options et configurations possibles sur demande.

## ÜBERSICHT | OVERVIEW | VUE D'ENSEMBLE

### TECHNICAL DATA

2700K / 3000K / 4000K

CRI>90

MacAdam ≤ 3

on-off / DALI / TRIAC

beam angle: 23° / 45°

L80 B10 50.000h



RAL colour of your choice



Contact us for more options...

### HOUSING COLOUR

schwarz | black | noir  
RAL 9005



silber | silver | argent  
RAL 9006



weiß | white | blanc  
RAL 9016



**EINBAULEUCHE „DOWN75“**  
**RECESSED LUMINAIRE “DOWN75”**  
**LUMINAIRE ENCASTRABLE « DOWN75 »**

Bestellbeispiel | Example order | Exemple de commande  
 Ø 75 mm, 23°, **CR190**, 4000K, **direct**, incl. driver on/off low output, black, **silver specular**

**DWD7E-239401-LOBLS**

- 1 2 3 4 5

**1 ABMESSUNG**  
 DIMENSIONS  
 DIMENSIONS

Ø 75 mm	<b>D7</b>
□ 75 x 75 mm	<b>S7</b>

**2 ABSTRAHLWINKEL**  
 BEAM ANGLE  
 ANGLE DE DIFFUSION

23°	<b>23</b>
45°	<b>45</b>

**3 FARBTEMPERATUR**  
 COLOUR TEMPERATURE  
 TEMPÉRATURE DE COULEUR

2700K	<b>27</b>
3000K	<b>30</b>
4000K	<b>40</b>

**4 LEISTUNG & STEUERUNG**  
 OUTPUT & CONTROL  
 SORTIE & CONTRÔLE

incl. driver on/off low output	<b>LO</b>
incl. driver DALI low output	<b>LD</b>
incl. driver TRIAC low output	<b>LT</b>
incl. driver TRIAC high output	<b>HT</b>
incl. driver on/off high output	<b>HO</b>
incl. driver DALI high output	<b>HD</b>

**5 GEHÄUSEFARBE**  
 HOUSING COLOUR  
 COULEUR DU BOÎTIER

white RAL 9016	<b>WH</b>
black RAL 9005	<b>BL</b>
silver RAL 9006	<b>SI</b>

square low output

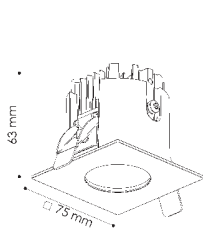

square high output

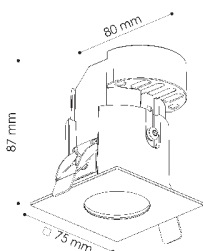

round low output

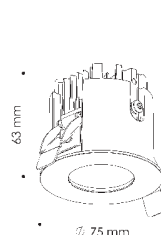

round high output

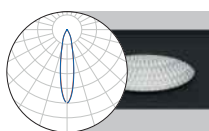
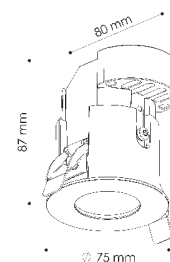

23°

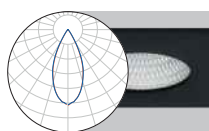

45°

low output high output

Size [mm]	low output [lm] / [W]	high output [lm] / [W]	low output [lm] / [W]	high output [lm] / [W]	low output [kg]	high output [kg]
Ø 75	957 / 10,5	1.330 / 14,2	959 / 10,5	1.341 / 14,2	0,30	0,45
□ 75 x 75	957 / 10,5	1.330 / 14,2	959 / 10,5	1.341 / 14,2	0,30	0,45



**CUTOUT**

Size [mm]	diameter [mm]	depth low [mm]	depth high [mm]
Ø 75	Ø 68	80	100
□ 75 x 75	Ø 68	80	100

Alle Lumenangaben für 4000K, CRI>90  
 All lumen values for 4000K, CRI>90  
 Toutes les données de lumens pour 4000K, CRI>90



**Runder LED-Einbaustrahler** direktstrahlend. Leuchte aus Aluminium-Druckguss mit einer Einbautiefe von 148 bzw. 171 mm. Durch den modularen Aufbau dieser Strahler-Familie gibt es die Leuchte wahlweise mit einem Durchmesser von 78 mm (Ausschnitt 68 mm) oder 110 mm (Ausschnitt 100 mm). Oberfläche der Leuchte feinstruktur matt pulverbeschichtet ähnlich RAL 9016 weiß oder ähnlich RAL 9005 schwarz. Das Baukasten-system ermöglicht das Auswählen von vier bzw. fünf unterschiedlichen Reflektoren: silber-hochglanz, silber-matt, schwarz-matt, gold-matt sowie silber-matt asymmetrisch für die Größe 110 mm. Die Leuchte kann wahlweise ohne Betriebsgerät oder inkl. LED-Treiber – on/off oder DALI – bestellt werden. Farbtemperaturen 2700K, 3000K oder 4000K – Farbwiedergabe CRI>90 – Mac Adam ≤3. Weitere Optionen und Konfigurationen auf Anfrage möglich.

**Round recessed LED spotlight** with direct beam. Luminaire made of die-cast aluminium with a mounting depth of 148 or 171 mm. Due to the modular design of this spotlight family, the luminaire is available either with a diameter of 78 mm (cut-out 68 mm) or 110 mm (cut-out 100 mm). Surface of the luminaire fine structure matt powder coated similar to RAL 9016 white or similar to RAL 9005 black. The modular system allows the selection of four or five different reflectors: silver specular, silver matt, black matt, gold matt as well as silver matt asymmetrical for the 110 mm size. The luminaire can be ordered either without power supply unit or incl. LED driver - on/off or DALI. Colour temperatures 2700K, 3000K or 4000K - colour rendering CRI>90 - Mac Adam ≤3. Further options and configurations available on request.

**Spot LED rond à encastrer** à éclairage direct. Luminaire en aluminium moulé sous pression avec une profondeur d'encastrement de 148 ou 171 mm. Grâce à la structure modulaire de cette famille de projecteurs, le luminaire est disponible au choix avec un diamètre de 78 mm (découpe de 68 mm) ou de 110 mm (découpe de 100 mm). La surface du luminaire est revêtue d'une structure fine mate, similaire au RAL 9016 blanc ou au RAL 9005 noir. Le système modulaire permet de choisir entre quatre ou cinq réflecteurs différents : argent brillant, argent mat, noir mat, or mat ainsi qu'argent mat asymétrique pour la taille 110 mm. Le luminaire peut être commandé au choix sans appareillage ou avec un pilote LED - on/off ou DALI. Températures de couleur 2700K, 3000K ou 4000K - Rendu des couleurs CRI>90 - Mac Adam ≤3. Autres options et configurations possibles sur demande.

## ÜBERSICHT | OVERVIEW | VUE D'ENSEMBLE

### TECHNICAL DATA

2700K / 3000K / 4000K

CRI>90

MacAdam ≤ 3

on-off / DALI

beam angle: 50° / 55° / asymmetric

L80 B10 50.000h



Contact us for more options...

### HOUSING COLOUR

schwarz | black | noir  
RAL 9005



weiß | white | blanc  
RAL 9016



### DECORATION RING COLOUR

silber hochglanz | silver specular |  
argenté brillant



schwarz matt | black matt | noir mat



silber matt | silver matt | argenté mat



gold matt | gold matt | doré mat



**EINBAULEUCHE „designDOT“**  
**RECESSED LUMINAIRE “designDOT”**  
**LUMINAIRE ENCASTRABLE « designDOT »**

Bestellbeispiel | Example order | Exemple de commande  
 78 mm, 55°, CRI>90, 4000K, direct, excl. driver, black, silver matt

**DD68E-559401-OOBLM**

1 2 3 4 5 6

<b>1</b>	<b>DURCHMESSER</b>	
	DIAMETER	
	DIAMÈTRE	
	78 mm	<b>68</b>
	110 mm	<b>10</b>

<b>2</b>	<b>ABSTRAHLWINKEL</b>	
	BEAM ANGLE	
	ANGLE DE DIFFUSION	
	50° (110 mm only)	<b>50</b>
	55° (78 mm only)	<b>55</b>
	asymmetric (110 mm only)	<b>AA</b>

<b>3</b>	<b>FARBTEMPERATUR</b>	
	COLOUR TEMPERATURE	
	TEMPÉRATURE DE COULEUR	
	2700K	<b>27</b>
	3000K	<b>30</b>
	4000K	<b>40</b>

<b>4</b>	<b>LEISTUNG &amp; STEUERUNG</b>	
	OUTPUT & CONTROL	
	SORTIE & CONTRÔLE	
	excl. driver	<b>NN</b>
	incl. driver on/off	<b>OO</b>
	incl. driver DALI	<b>DD</b>

<b>5</b>	<b>GEHÄUSEFARBE</b>	
	HOUSING COLOUR	
	COULEUR DU BOÎTIER	
	white RAL 9016	<b>WH</b>
	black RAL 9005	<b>BL</b>

<b>6</b>	<b>REFLEKTOR FARBE</b>	
	REFLECTOR COLOUR	
	COULEUR DU RÉFLECTEUR	
	silver specular	<b>S</b>
	silver matt	<b>M</b>
	black matt	<b>B</b>
	gold matt	<b>G</b>
	asymmetric (110 mm only)	<b>A</b>

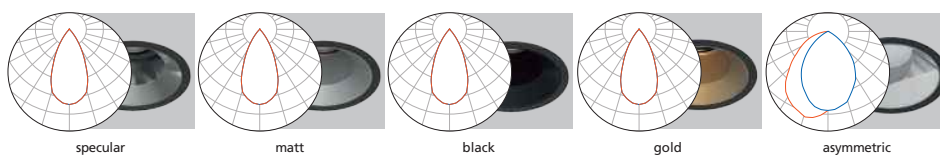
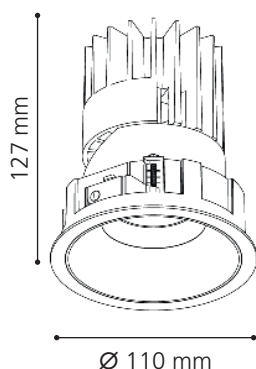
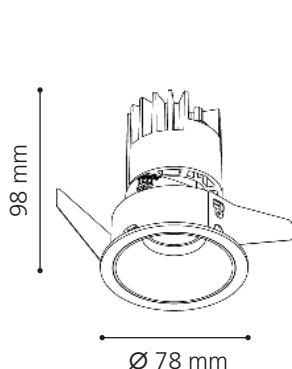

Size [mm]	specular single output [lm] / [W]	matt single output [lm] / [W]	black single output [lm] / [W]	gold single output [lm] / [W]	asymmetric single output [lm] / [W]	[kg]
Ø 78	873 / 13,0	860 / 13,0	869 / 13,0	873 / 13,0	-	0,5
Ø 110	1.382 / 20,0	1.389 / 20,0	1.389 / 20,0	1.382 / 20,0	553 / 20,0	0,8



**CUTOUT**

Size [mm]	diameter [mm]	depth [mm]
Ø 78	Ø 68	148
Ø 110	Ø 100	171

Alle Lumenangaben für 4000K  
 All lumen values for 4000K  
 Toutes les données de lumens pour 4000K





**Quadratischer LED-Einbaustrahler** direktstrahlend. Leuchte aus Aluminium-Druckguss mit einer Einbautiefe von 148 bzw. 171 mm. Durch den modularen Aufbau dieser Strahler-Familie gibt es die Leuchte wahlweise mit den Abmessungen 78x78 mm (Ausschnitt 68x68 mm) oder 107x107 mm (Ausschnitt 96x96 mm). Oberfläche der Leuchte feinstruktur matt pulverbeschichtet ähnlich RAL 9016 weiß oder ähnlich RAL 9005 schwarz. Das Baukastensystem ermöglicht das Auswählen von vier bzw. fünf unterschiedlichen Reflektoren: silberhochglanz, silber-matt, schwarz-matt, gold-matt sowie silber-matt asymmetrisch für die Größe 107x107 mm. Die Leuchte kann wahlweise ohne Betriebsgerät oder inkl. LED-Treiber – on/off oder DALI – bestellt werden. Farbtemperaturen 2700K, 3000K oder 4000K – Farbwiedergabe CRI>90 – Mac Adam ≤3. Weitere Optionen und Konfigurationen auf Anfrage möglich.

**Square recessed LED spotlight** with direct beam. Luminaire made of die-cast aluminium with a mounting depth of 148 or 171 mm. Due to the modular design of this spotlight family, the luminaire is available either with the dimensions 78x78 mm (cut-out 68x68 mm) or 107x107 mm (cut-out 96x96 mm). Surface of the luminaire fine structure matt powder coated similar to RAL 9016 white or similar to RAL 9005 black. The modular system allows the selection of four or five different reflectors: silver specular, silver matt, black matt, gold matt as well as silver matt asymmetrical for the size 107x107 mm. The luminaire can be ordered either without power supply unit or incl. LED driver - on/off or DALI. Colour temperatures 2700K, 3000K or 4000K - colour rendering CRI>90 - Mac Adam ≤3. Further options and configurations available on request.

**Spot LED encastré carré** à éclairage direct. Luminaire en aluminium moulé sous pression avec une profondeur d'encastrément de 148 ou 171 mm. Grâce à la structure modulaire de cette famille de projecteurs, le luminaire est disponible au choix dans les dimensions 78x78 mm (découpe 68x68 mm) ou 107x107 mm (découpe 96x96 mm). La surface du luminaire est revêtue d'une structure fine mate, similaire au RAL 9016 blanc ou au RAL 9005 noir. Le système modulaire permet de choisir entre quatre ou cinq réflecteurs différents : argent brillant, argent mat, noir mat, or mat ainsi qu'argent mat asymétrique pour la taille 107x107 mm. Le luminaire peut être commandé au choix sans appareillage ou avec un pilote LED - on/off ou DALI. Températures de couleur 2700K, 3000K ou 4000K - Rendu des couleurs CRI>90 - Mac Adam ≤3. Autres options et configurations possibles sur demand.

## ÜBERSICHT | OVERVIEW | VUE D'ENSEMBLE

### TECHNICAL DATA

2700K / 3000K / 4000K

CRI>90

MacAdam ≤ 3

on-off / DALI

beam angle: 50° / 55° / asymmetric

L80 B10 50.000h



Contact us for more options...

### HOUSING COLOUR

schwarz | black | noir  
RAL 9005



weiß | white | blanc  
RAL 9016



### DECORATION RING COLOUR

silber hochglanz | silver specular |  
argenté brillant



schwarz matt | black matt | noir mat



silber matt | silver matt | argenté mat



gold matt | gold matt | doré mat



**EINBAULEUCHE „designSQOT“**  
**RECESSED LUMINAIRE“ designSQOT“**  
**LUMINAIRE ENCASTRABLE « designSQOT »**

Bestellbeispiel | Example order | Exemple de commande  
 78 x 78 mm, 55°, CRI>90, 4000K, **direct**, excl. driver, black, silver matt

**DS68E-559401-OOBLM**

1 2 3 4 5 6

**1 GRÖSSE**  
 SIZE  
 TAILLE

78 x 78 mm	<b>68</b>
107 x 107 mm	<b>10</b>

**2 ABSTRAHLWINKEL**  
 BEAM ANGLE  
 ANGLE DE DIFFUSION

50° (107 mm only)	<b>50</b>
55° (78 mm only)	<b>55</b>
asymmetric (107 mm only)	<b>AA</b>

**3 FARBTemperatur**  
 COLOUR TEMPERATURE  
 TEMPÉRATURE DE COULEUR

2700K	<b>27</b>
3000K	<b>30</b>
4000K	<b>40</b>

**4 LEISTUNG & STEUERUNG**  
 OUTPUT & CONTROL  
 SORTIE & CONTRÔLE

excl. driver	<b>NN</b>
incl. driver on/off	<b>OO</b>
incl. driver DALI	<b>DD</b>

**5 GEHÄUSEFARBE**  
 HOUSING COLOUR  
 COULEUR DU BOÎTIER

white RAL 9016	<b>WH</b>
black RAL 9005	<b>BL</b>

**6 REFLEKTOR FARBE**  
 REFLECTOR COLOUR  
 COULEUR DU RÉFLECTEUR

silver specular	<b>S</b>
silver matt	<b>M</b>
black matt	<b>B</b>
gold matt	<b>G</b>
asymmetric (107 mm only)	<b>A</b>

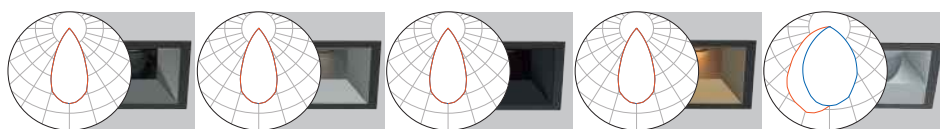
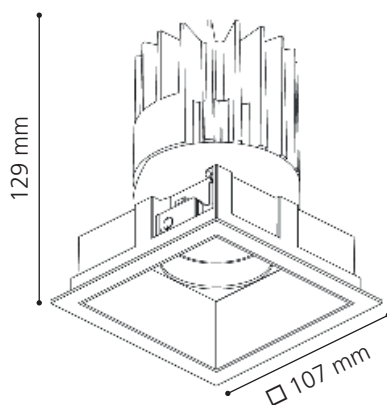
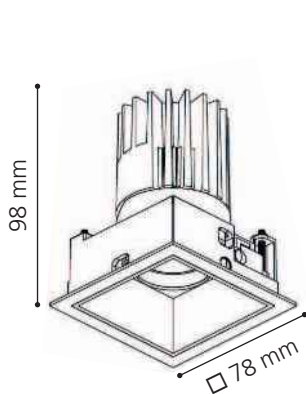

Size [mm]	specular single output [lm] / [W]	matt single output [lm] / [W]	black single output [lm] / [W]	gold single output [lm] / [W]	asymmetric single output [lm] / [W]	[kg]
□ 78	873 / 13,0	860 / 13,0	869 / 13,0	873 / 13,0	-	0,5
□ 107	1.382 / 20,0	1.389 / 20,0	1.389 / 20,0	1.382 / 20,0	553 / 20,0	0,8



**CUTOUT**

Size [mm]	cutout [mm]	depth [mm]
□ 78	□ 68	148
□ 107	□ 96	171

Alle Lumenangaben für 4000K  
 All lumen values for 4000K  
 Toutes les données de lumens pour 4000K



**Runder LED-Einbaudownlight direktstrahlend.** Leuchte aus Aluminium-Druckguss mit einer Einbautiefe von 122, 150 bzw. 180 mm. Durch den modularen Aufbau dieser Strahler-Familie gibt es die Leuchte wahlweise mit einem Durchmesser von 84 mm (Ausschnitt 75 mm), 162 mm (Ausschnitt 150 mm) oder 216 mm (Ausschnitt 200 mm). Oberfläche der Leuchte feinstruktur matt pulverbeschichtet ähnlich RAL 9016 weiß oder ähnlich RAL 9005 schwarz. Das Baukastensystem ermöglicht das Auswählen von zwei unterschiedliche Reflektor-Farben: silber-matt oder schwarz-matt für eine reduzierte Leuchtdichte (UGR<19). Die Leuchte kann wahlweise ohne Betriebsgerät oder inkl. LED-Treiber in verschiedenen Leistungsstufen – on/off oder DALI – bestellt werden. Farbtemperaturen 3000K oder 4000K für alle Größen, dynamisch Weiß (2700K–6500K) nur für die Größen 162 und 216 mm – Farbwiedergabe CRI>90 – Mac Adam ≤3. Weitere Optionen und Konfigurationen auf Anfrage möglich.

**Round recessed LED downlight with direct beam.** Luminaire made of die-cast aluminium with a mounting depth of 122, 150 or 180 mm. Due to the modular design of this spotlight family, the luminaire is available either with a diameter of 84 mm (cut-out 75 mm), 162 mm (cut-out 150 mm) or 216 mm (cut-out 200 mm). Surface of the luminaire fine structure matt powder coated similar to RAL 9016 white or similar to RAL 9005 black. The modular system allows the selection of two different reflector colours: matt silver or matt black for reduced luminance (UGR<19). The luminaire can be ordered either without power supply unit or incl. LED driver in various power levels - on/off or DALI. Colour temperatures 3000K or 4000K for all sizes, dynamic white (2700K-6500K) only for sizes 162 and 216 mm - colour rendering CRI>90 - Mac Adam ≤3. Further options and configurations available on request.

**Spot LED rond à encastrer à éclairage direct.** Luminaire en aluminium moulé sous pression avec une profondeur d'encastrement de 148 ou 171 mm. Grâce à la structure modulaire de cette famille de projecteurs, le luminaire est disponible au choix avec un diamètre de 78 mm (découpe de 68 mm) ou de 110 mm (découpe de 100 mm). La surface du luminaire est revêtue d'une structure fine mate, similaire au RAL 9016 blanc ou au RAL 9005 noir. Le système modulaire permet de choisir entre quatre ou cinq réflecteurs différents : argent brillant, argent mat, noir mat, or mat ainsi qu'argent mat asymétrique pour la taille 110 mm. Le luminaire peut être commandé au choix sans appareillage ou avec un pilote LED - on/off ou DALI. Températures de couleur 2700K, 3000K ou 4000K - Rendu des couleurs CRI>90 - Mac Adam ≤3. Autres options et configurations possibles sur demande.

## ÜBERSICHT | OVERVIEW | VUE D'ENSEMBLE

### TECHNICAL DATA

3000K / 4000K / 2700-6500K

CRI>90

MacAdam ≤ 3

on-off / DALI

beam angle: 50° / 60°

L80 B10 50.000h



Contact us for more options...

### HOUSING COLOUR

schwarz | black | noir  
RAL 9005



weiß | white | blanc  
RAL 9016



### REFLECTOR COLOUR

silber matt | silver matt | argenté mat



schwarz matt | black matt | noir mat



**EINBAULEUCHE „techDOT“**  
**RECESSED LUMINAIRE “techDOT”**  
**LUMINAIRE ENCASTRABLE « techDOT »**

Bestellbeispiel | Example order | Exemple de commande  
 162 mm, 60°, CRI>90, 4000K, direct, low output on/off, black, silver matt

**TD15E-609401-LOBLM**

1 2 3 4 5 6

**1 DURCHMESSER**  
**DIAMETER**  
**DIAMÈTRE**

84 mm (NN, OO, DD only)	<b>75</b>
162 mm	<b>15</b>
216 mm	<b>20</b>

**2 ABSTRAHLWINKEL**  
**BEAM ANGLE**  
**ANGLE DE DIFFUSION**

50° (84 mm only)	<b>50</b>
60° (162 & 216 mm only)	<b>60</b>

**3 FARBTEMPERATUR**  
**COLOUR TEMPERATURE**  
**TEMPÉRATURE DE COULEUR**

3000K	<b>30</b>
4000K	<b>40</b>
2700-6500K	<b>DW</b>

**4 LEISTUNG & STEUERUNG**  
**OUTPUT & CONTROL**  
**SORTIE & CONTRÔLE**

excl. driver	<b>NN</b>
driver on/off (84 mm only)	<b>OO</b>
driver DALI (84 mm only)	<b>DD</b>
low output on/off	<b>LO</b>
low output DALI (DM 216 mm only)	<b>LD</b>
high output on/off	<b>HO</b>
high output DALI	<b>HD</b>
dynamic white DALI DT8	<b>DW</b>

**5 GEHÄUSEFARBE**  
**HOUSING COLOUR**  
**COULEUR DU BOÎTIER**

white RAL 9016	<b>WH</b>
black RAL 9005	<b>BL</b>

**6 REFLEKTOR FARBE**  
**REFLECTOR COLOUR**  
**COULEUR DU RÉFLECTEUR**

silver matt	<b>M</b>
black matt	<b>B</b>

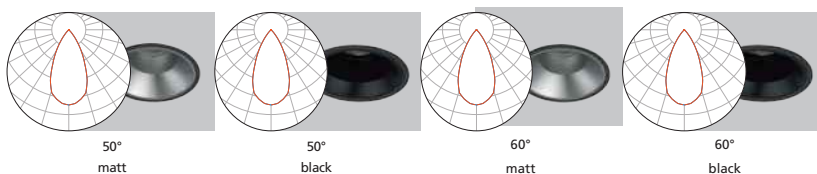
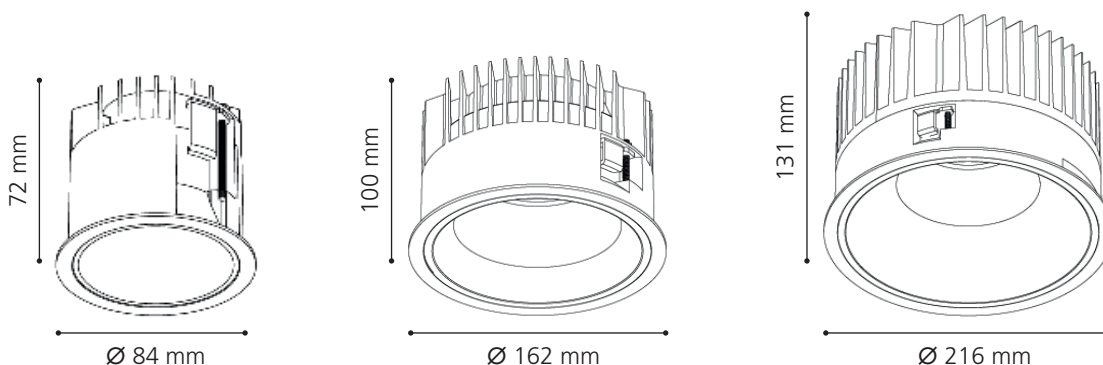

Size [mm]	output [lm] / [W]	output [lm] / [W]	low output [lm] / [W]	high output [lm] / [W]	low output [lm] / [W]	high output [lm] / [W]	KE
Ø 84	1.077 / 13,5	1.070 / 13,5	-	-	-	-	0,8
Ø 162	-	-	1.333 / 15,5	2.399 / 29,0	1.277 / 15,5	2.299 / 29,0	1,1
Ø 216	-	-	2.350 / 26	4.700 / 52,0	2.300 / 26,0	4.600 / 52,0	2,0



**CUTOUT**

Size [mm]	diameter [mm]	depth [mm]
Ø 84	Ø 75	122
Ø 162	Ø 150	150
Ø 216	Ø 200	180

Alle Lumenangaben für 4000K  
 All lumen values for 4000K  
 Toutes les données de lumens pour 4000K



Quadratischer LED-Einbaudownlight direktstrahlend. Leuchte aus Aluminium-Druckguss mit einer Einbautiefe von 150 bzw. 180 mm. Durch den modularen Aufbau dieser Strahler-Familie gibt es die Leuchte wahlweise mit den Abmessungen 167x167 mm (Ausschnitt 150x150 mm) oder 216x216 mm (Ausschnitt 200x200 mm). Oberfläche der Leuchte feinstruktur matt pulverbeschichtet ähnlich RAL 9016 weiß oder ähnlich RAL 9005 schwarz. Das Baukastensystem ermöglicht das Auswählen von zwei unterschiedlichen Reflektor-Farben: silber-matt oder schwarz-matt für eine reduzierte Leuchtdichte (UGR<19). Die Leuchte kann wahlweise ohne Betriebsgerät oder inkl. LED-Treiber in verschiedenen Leistungsstufen – on/off oder DALI – bestellt werden. Farbtemperaturen 3000K, 4000K oder dynamisch Weiß (2700K–6500K) – Farbwiedergabe CRI>90 – Mac Adam ≤3. Weitere Optionen und Konfigurationen auf Anfrage möglich.

Square recessed LED downlight with direct beam. Luminaire made of die-cast aluminium with a mounting depth of 150 or 180 mm. Due to the modular design of this spotlight family, the luminaire is available either with the dimensions 167x167 mm (cut-out 150x150 mm) or 216x216 mm (cut-out 200x200 mm). Surface of the luminaire fine structure matt powder coated similar to RAL 9016 white or similar to RAL 9005 black. The modular system allows the selection of two different reflector colours: matt silver or matt black for reduced luminance (UGR<19). The luminaire can either be ordered without power supply unit or incl. LED driver in various power levels - on/off or DALI. Colour temperatures 3000K, 4000K or dynamic white (2700K-6500K) - colour rendering CRI>90 - Mac Adam ≤3. Further options and configurations available on request.

Spot encastré à LED carré à éclairage direct. Luminaire en aluminium moulé sous pression avec une profondeur d'encastrément de 150 ou 180 mm. Grâce à la structure modulaire de cette famille de projecteurs, le luminaire est disponible au choix avec les dimensions 167x167 mm (découpe 150x150 mm) ou 216x216 mm (découpe 200x200 mm). La surface du luminaire est revêtue d'une structure fine mate, similaire au RAL 9016 blanc ou au RAL 9005 noir. Le système modulaire permet de choisir entre deux couleurs de réflecteur différentes : argent mat ou noir mat pour un éblouissement réduit (UGR<19). Le luminaire peut être commandé au choix sans appareillage ou avec un pilote LED à différents niveaux de puissance - on/off ou DALI. Températures de couleur 3000K, 4000K ou blanc dynamique (2700K-6500K) - Rendu des couleurs CRI>90 - Mac Adam ≤3. Autres options et configurations possibles sur demande.

## ÜBERSICHT | OVERVIEW | VUE D'ENSEMBLE

### TECHNICAL DATA

3000K / 4000K / 2700-6500K

CRI>90

MacAdam ≤ 3

on-off / DALI

beam angle: 70°

L80 B10 50.000h



Contact us for more options...

### HOUSING COLOUR

schwarz | black | noir  
RAL 9005



weiß | white | blanc  
RAL 9016



### REFLECTOR COLOUR

silber matt | silver matt | argenté mat



schwarz matt | black matt | noir mat



**EINBAULEUCHE „techSQOT“**  
**RECESSED LUMINAIRE “techSQOT”**  
**LUMINAIRE ENCASTRABLE « techSQOT »**

Bestellbeispiel | Example order | Exemple de commande  
 167 x 167 mm, 70°, CRI>90, 4000K, direct, low output on/off, black, silver matt

**TS15E-709401-LOBLM**

1 2 3 4 5

1 GRÖSSE SIZE TAILLE	
167 x 167 mm	15
220 x 220 mm	20

2 FARBTEMPERATUR COLOUR TEMPERATURE TEMPÉRATURE DE COULEUR	
3000K	30
4000K	40
2700-6500K	DW

3 LEISTUNG & STEUERUNG OUTPUT & CONTROL SORTIE & CONTRÔLE	
excl. driver	NN
low output on/off	LO
low output DALI (220 mm only)	LD
high output on/off	HO
high output DALI	HD
dynamic white DALI DT8	DW

4 GEHÄUSEFARBE HOUSING COLOUR COULEUR DU BOÎTIER	
white RAL 9016	WH
black RAL 9005	BL

5 REFLEKTOR FARBE REFLECTOR COLOUR COULEUR DU RÉFLECTEUR	
silver matt	M
black matt	B

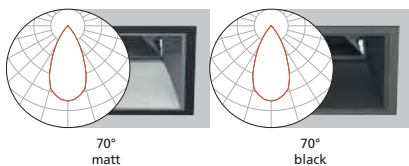
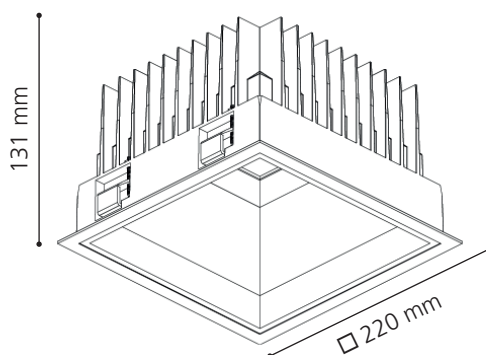
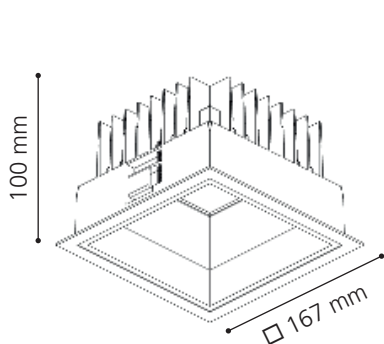

Size [mm]	70° matt		70° black		
	low output [lm] / [W]	high output [lm] / [W]	low output [lm] / [W]	high output [lm] / [W]	
□ 167	1.333 / 15,5	2.399 / 29,0	1.277 / 15,5	2.299 / 29,0	1,1
□ 220	2.350 / 26,0	4.700 / 52,0	2.300 / 26,0	4.600 / 52,0	1,8



**CUTOUT**

Size [mm]	cutout [mm]	depth [mm]
□ 167	150	150
□ 220	200	180

Alle Lumenangaben für 4000K  
 All lumen values for 4000K  
 Toutes les données de lumens pour 4000K



# OVERVIEW

**STEH- UND TISCHKLEMMLEUCHTEN** | FREE-STANDING AND DESK-MOUNTED LUMINAIRE | *LAMPADAIRE, MONTAGE SUR TABLE*



officeLINE50free

**222**



officeLINE50free

**224**

# STEH- UND TISCHKLEMMLEUCHTEN

FREE-STANDING AND DESK-MOUNTED LUMINAIRES

*LUMINAIRES SUR PIED ET SUR TABLE*

# officeLINE50free

STEHLEUCHE | FREE-STAND | LAMPADAIRE

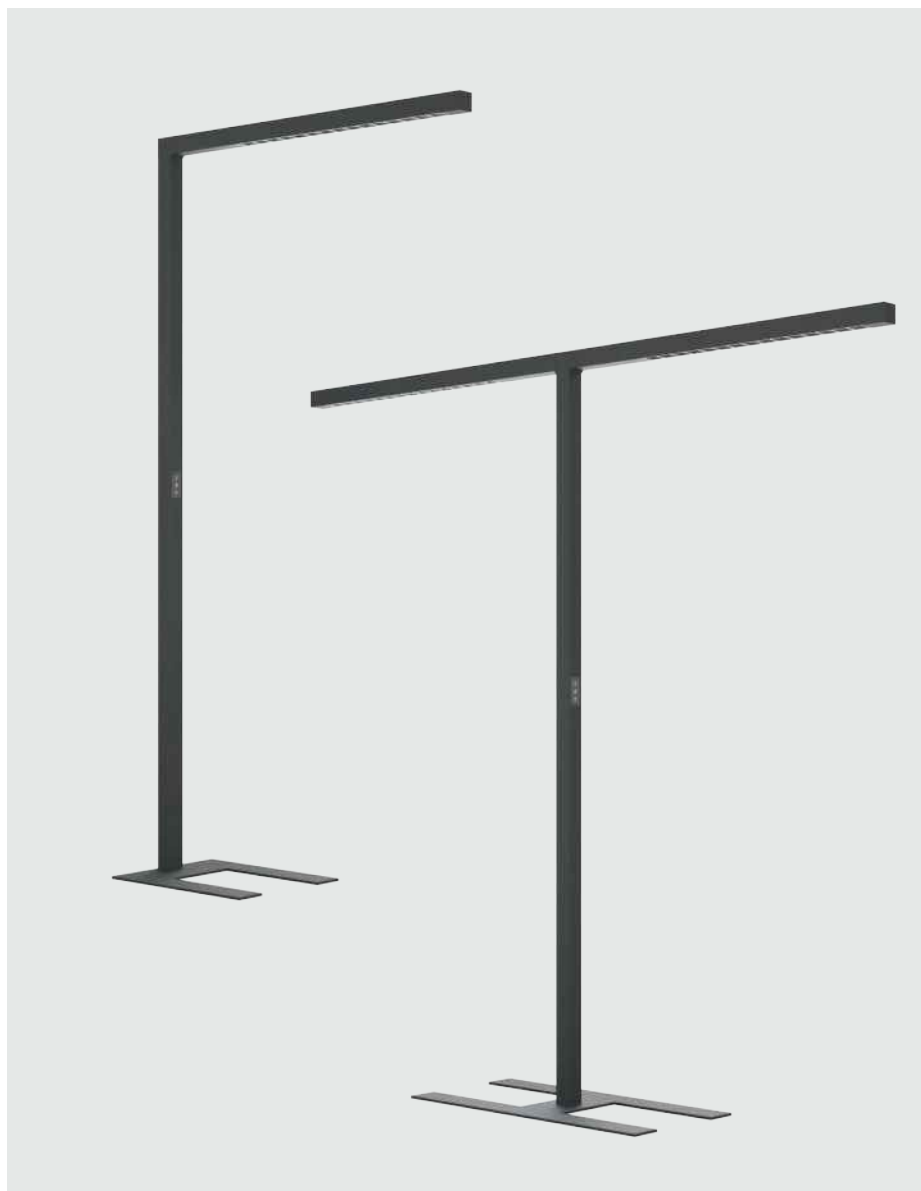

**LED-Stehleuchte** direkt/indirektstrahlend für Büroanwendungen. Lichtkanal aus Aluminium-Strangpressprofil mit einer Breite von 50mm. Oberfläche der Leuchte feinstrukturiert matt pulverbeschichtet ähnlich RAL 9016 weiß, RAL 9006 silber oder RAL 9005 schwarz – auf Anfrage in RAL nach Wahl. Die Stehleuchte ist ausgestattet mit einem hochwertigen, facettierten BAP-Raster mit einer Auswahl an sieben verschiedenen Farben – Oberfläche hochglänzend bzw. matt. Die Steuerung der Leuchte erfolgt über ein Touchpanel – wahlweise direkt/indirekt getrennt schalt- und dimmbar oder mit Multisensor (Bewegungs- und Tageslichtsensor). Farbtemperaturen 2700K, 3000K, 4000K oder dynamisch Weiß (2700K-6500K) – Farbwiedergabe CRI>80 oder CRI>90 – Mac Adam ≤3. Wählbar zwischen einer Single Head Variante für Doppelarbeitsplätze oder einer Double Head Variante für Vierfcharbeitsplätze. 3000mm Anschlusskabel wahlweise mit länderspezifischem Stecker Schuko CEE 7/7 (Type E+F), CH T12 (Type J) oder UK BS 1363 (Type G).

**Free-standing LED luminaire** with direct/indirect beam for office applications. Light channel made of extruded aluminium profile with a width of 50 mm. Surface of the luminaire fine structured matt powder coated finish similar to RAL 9016 white, RAL 9006 silver or RAL 9005 black – on request in RAL of choice. The luminaire is equipped with a high-quality, faceted BAP louvre with a choice of seven different colours – specular or matt finish. The luminaire is controlled via a touchpanel - optionally with direct/indirect separate switching and dimming or with multi-sensor (motion and daylight sensor). Colour temperatures 2700K, 3000K, 4000K or dynamic white (2700K-6500K) – colour rendering CRI>80 or CRI>90 - Mac Adam ≤3. Selectable between a single head version for double workstations or a double head version for quadruple workstations. 3000mm connection cable selectable with country-specific plug Schuko CEE 7/7 (type E+F), CH T12 (type J) or UK BS 1363 (type G).

**Lampadaire LED** à éclairage direct/indirect pour les applications bureautiques. Canal lumineux en profile d'aluminium extrudé d'une largeur de 50 mm. Surface du luminaire à structure fine, revêtement par poudre mat similaire à RAL 9016 blanc, RAL 9006 argent ou RAL 9005 noir – sur demande en RAL au choix. Le luminaire est équipé d'une grille BAP à facettes de haute qualité avec un choix de sept couleurs différentes – surface brillante ou mate. Le luminaire est commandé par un écran tactile - au choix avec commutation et gradation séparées directes/indirectes ou avec multi-capteur (détecteur de mouvement et de lumière du jour). Températures de couleur 2700K, 3000K, 4000K ou blanc dynamique (2700K-6500K) – Rendu des couleurs CRI>80 ou CRI>90 - Mac Adam ≤3. Choix entre une version à une tête pour les postes de travail doubles ou une version à deux têtes pour les postes de travail quadruples. Câble de raccordement de 3 000 mm pouvant être équipé d'une fiche Schuko CEE 7/7 (type E+F), CH T12 (type J) ou UK BS 1363 (type G) spécifique à chaque pays.

## ÜBERSICHT | OVERVIEW | VUE D'ENSEMBLE

### TECHNICAL DATA

2700K / 3000K / 4000K / 2700-6500K

CRI>80 / CRI>90

MacAdam ≤ 3

up to 141 lm/W

dimmable / dimmable + multisensor

direct/indirect

BAP Louvre (UGR <19)

L80 B10 50.000h



RAL colour of your choice



Contact us for more options...

### HOUSING COLOUR

schwarz | black | noir  
RAL 9005



silber | silver | argent  
RAL 9006



weiß | white | blanc  
RAL 9016



### BAP LOUVRE COLOUR

silber hochglanz | silver specular | argenté brillant



gold hochglanz | gold specular | doré brillant



silber matt | silver matt | argenté mat



bronze hochglanz | bronze specular | bronze brillant



schwarz hochglanz | black specular | noir brillant



titan hochglanz | titan specular | titan brillant



schwarz matt | black matt | noir mat



# STEHLEUCHTE „officeLINE50free“

FREE-STAND "officeLINE50free"

LAMPADAIRE « officeLINE50free »

Bestellbeispiel | Example order | Exemple de commande

**Free-Stand** Single head, 1055 mm, CRI90, 4000K, **direct + indirect**, high output dimmable with Multisensor, Schuko CEE 7/7 (Type E+F), black, gold specular

**OL50S-1E9402-HSBLG**

1 2 3 4 5 6 7

**1 KONFIGURATION**  
CONFIGURATION  
CONFIGURATION

Single head	<b>1</b>
Double head	<b>2</b>

**2 STECKER**  
PLUG  
PRISE

Schuko CEE 7/7 (Type E+F)	<b>E</b>
CH T12 (Type J)	<b>C</b>
UK BS 1363 (Type G)	<b>U</b>

**3 FARBWIEDERGABE**  
COLOUR RENDERING  
RENDU DES COULEURS

CRI>80	<b>8</b>
CRI>90	<b>9</b>

**4 FARBTEMPERATUR**  
COLOUR TEMPERATURE  
TEMPÉRATURE DE COULEUR

2700K (CRI>90 only)	<b>27</b>
3000K	<b>30</b>
4000K	<b>40</b>
2700-6500K (CRI>90 only)	<b>DW</b>

**5 LEISTUNG & STEUERUNG**  
OUTPUT & CONTROL  
SORTIE & CONTRÔLE

low output - dimmable	<b>LD</b>
low output - dimmable multisensor	<b>LS</b>
high output - dimmable	<b>HD</b>
high output - dimmable multisensor	<b>HS</b>
dynamic white - dimmable multisensor	<b>DW</b>

**6 GEHÄUSEFARBE**  
HOUSING COLOUR  
COULEUR DU BOÎTIER

silver RAL 9006	<b>SI</b>
white RAL 9016	<b>WH</b>
black RAL 9005	<b>BL</b>

**7 BAP-RASTER FARBE**  
BAP LOUVRE COLOUR  
GRILLE BAP COULEUR

silver specular	<b>S</b>
silver matt	<b>M</b>
black specular	<b>N</b>
black matt	<b>B</b>
gold specular	<b>G</b>
bronze specular	<b>C</b>
titan specular	<b>T</b>

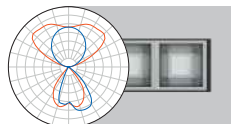
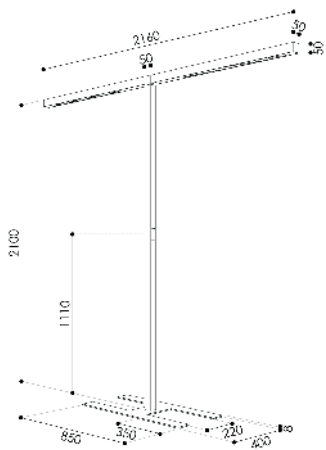
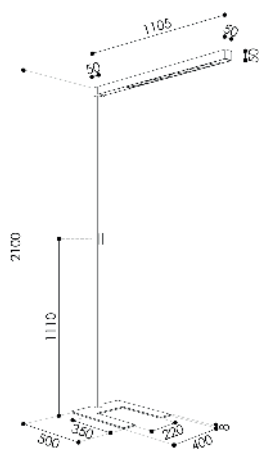

direct + indirect

Configuration	low output [lm] / [W]	high output [lm] / [W]	 [kg]
Single head	8.653 / 62,2	12.002 / 89,0	17,7
Double head	17.306 / 122,4	24.004 / 176,0	22,3

Alle Lumenangaben für 4000K, CRI>80, Reflektor silber hochglanz  
All lumen values for 4000K, CRI>80, reflector silver specular  
Toutes les données de lumens pour 4000K, CRI>80, réflecteur argenté brillant

# officeLINE50free

TISCHKLEMMLEUCHE | DESK-MOUNTED LUMINAIRE | LUMINAIRE MONTAGE SUR TABLE



**LED-Tischleuchte** direkt/indirekt strahlend für Büroanwendungen. Lichtkanal aus Aluminium-Strangpressprofil mit einer Breite von 50mm. Oberfläche der Leuchte feinstruktur matt pulverbeschichtet ähnlich RAL 9016 weiß, RAL 9006 silber oder RAL 9005 schwarz – auf Anfrage in RAL nach Wahl. Die Tischleuchte ist ausgestattet mit einem hochwertigen, facettierten BAP-Raster mit einer Auswahl an sieben verschiedenen Farben – Oberfläche hochglänzend bzw. matt. Die Steuerung der Leuchte erfolgt über ein Touchpanel – wahlweise direkt/indirekt getrennt schalt- und dimmbar oder mit Multisensor (Bewegungs- und Tageslichtsensor). Farbtemperaturen 2700K, 3000K, 4000K oder dynamisch Weiß (2700K-6500K) – Farbwiedergabe CRI>80 oder CRI>90 – Mac Adam ≤3. 3000mm Anschlusskabel wahlweise mit länderspezifischem Stecker Schuko CEE 7/7 (Type E+F), CH T12 (Type J) oder UK BS 1363 (Type G).

**Desk-mounted LED luminaire** with direct/indirect beam for office applications. Light channel made of extruded aluminium profile with a width of 50 mm. Surface of the luminaire fine structured matt powder coated finish similar to RAL 9016 white, RAL 9006 silver or RAL 9005 black – on request in RAL of choice. The desk-mounted luminaire is equipped with a high-quality, faceted BAP louvre with a choice of seven different colours – specular or matt finish. The luminaire is controlled via a touchpanel - optionally with direct/indirect separate switching and dimming or with multi-sensor (motion and daylight sensor). Colour temperatures 2700K, 3000K, 4000K or dynamic white (2700K-6500K) – colour rendering CRI>80 or CRI>90 - Mac Adam ≤3. 3000mm connection cable selectable with country-specific plug Schuko CEE 7/7 (type E+F), CH T12 (type J) or UK BS 1363 (type G).

**Luminaire LED monté sur table** à éclairage direct/indirect pour les applications bureautiques. Canal lumineux en profile d'aluminium extrudé d'une largeur de 50 mm. Surface du luminaire à structure fine, revêtement par poudre mat similaire à RAL 9016 blanc, RAL 9006 argent ou RAL 9005 noir – sur demande en RAL au choix. Le luminaire est équipé d'une grille BAP à facettes de haute qualité avec un choix de sept couleurs différentes – surface brillante ou mate. Le luminaire est commandé par un écran tactile - au choix avec commutation et gradation séparées directes/indirectes ou avec multi-capteur (détecteur de mouvement et de lumière du jour). Températures de couleur 2700K, 3000K, 4000K ou blanc dynamique (2700K-6500K) – Rendu des couleurs CRI>80 ou CRI>90 - Mac Adam ≤3. Câble de raccordement de 3 000 mm pouvant être équipé d'une fiche Schuko CEE 7/7 (type E+F), CH T12 (type J) ou UK BS 1363 (type G) spécifique à chaque pays.

## ÜBERSICHT | OVERVIEW | VUE D'ENSEMBLE

### TECHNICAL DATA

2700K / 3000K / 4000K / 2700-6500K

CRI>80 / CRI>90

MacAdam ≤ 3

up to 139 lm/W

dimmable / dimmable + Touchpanel

direct/indirect

BAP Louvre (UGR <19)

L80 B10 50.000h



RAL colour of your choice



Contact us for more options...

### HOUSING COLOUR

schwarz | black | *noir*  
RAL 9005



silber | silver | *argent*  
RAL 9006



weiß | white | *blanc*  
RAL 9016



### BAP LOUVRE COLOUR

silber hochglanz | silver specular | *argenté brillant*



gold hochglanz | gold specular | *doré brillant*



silber matt | silver matt | *argenté mat*



bronze hochglanz | bronze specular | *bronze brillant*



schwarz hochglanz | black specular | *noir brillant*



titan hochglanz | titan specular | *titan brillant*



schwarz matt | black matt | *noir mat*



**TISCHKLEMMLEUCHE „officeLINE50free“**  
 DESK-MOUNTED LUMINAIRE "officeLINE50free"  
 LUMINAIRE MONTAGE SUR TABLE « officeLINE50free »

Bestellbeispiel | Example order | Exemple de commande

**Desk-mounted Single head, 1055 mm, CRI90, 4000K, direct + indirect,**  
 high output dimmable with Multisensor, Schuko CEE 7/7 (Type E+F), black, gold specular

**OL50D-1 E 9 402-HSBLG**

1 2 3 4 5 6

**1 STECKER**  
 PLUG  
 PRISE

Schuko CEE 7/7 (Type E+F)	<b>E</b>
CH T12 (Type J)	<b>C</b>
UK BS 1363 (Type G)	<b>U</b>

**2 FARBWIEDERGABE**  
 COLOUR RENDERING  
 RENDU DES COULEURS

CRI>80	<b>8</b>
CRI>90	<b>9</b>

**3 FARBTEMPERATUR**  
 COLOUR TEMPERATURE  
 TEMPÉRATURE DE COULEUR

2700K (CRI>90 only)	<b>27</b>
3000K	<b>30</b>
4000K	<b>40</b>
2700-6500K (CRI>90 only)	<b>DW</b>

**4 LEISTUNG & STEUERUNG**  
 OUTPUT & CONTROL  
 SORTIE & CONTRÔLE

low output - dimmable	<b>LD</b>
low output - dimmable multisensor	<b>LS</b>
high output - dimmable	<b>HD</b>
high output - dimmable multisensor	<b>HS</b>
dynamic white - dimmable multisensor	<b>DW</b>

**5 GEHÄUSEFARBE**  
 HOUSING COLOUR  
 COULEUR DU BOÎTIER

silver RAL 9006	<b>SI</b>
white RAL 9016	<b>WH</b>
black RAL 9005	<b>BL</b>

**6 BAP-RASTER FARBE**  
 BAP LOUVRE COLOUR  
 GRILLE BAP COULEUR

silver specular	<b>S</b>
silver matt	<b>M</b>
black specular	<b>N</b>
black matt	<b>B</b>
gold specular	<b>G</b>
bronze specular	<b>C</b>
titan specular	<b>T</b>

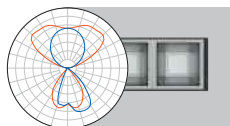
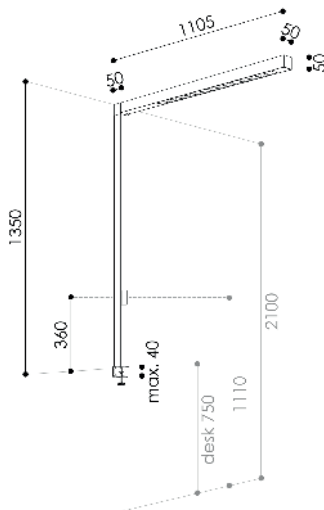

direct + indirect

Configuration	low output [lm] / [W]	high output [lm] / [W]	
Single head	8.653 / 62,2	12.002 / 89,0	5,8

Alle Lumenangaben für 4000K, CRI>80, Reflektor silber hochglanz  
 All lumen values for 4000K, CRI>80, reflector silver specular  
 Toutes les données de lumens pour 4000K, CRI>80, réflecteur argenté brillant



# OVERVIEW

SCHIENENSTRAHLER | TRACK SPOTLIGHTS | PROJECTEURS SUR RAIL



GLOWmini  
**228**



GLOWsmall  
**230**



GLOWmedium  
**232**



GLOWlarge  
**234**



GLOWultra  
**236**



GLOWgu10  
**238**



trackS  
**240**



trackM  
**242**



LINE50  
**244**



officeLINE50  
**246**

# SCHIENENSTRAHLER

TRACK SPOTLIGHTS

*PROJECTEURS SUR RAIL*

# GLOWmini

SCHIENENSTRAHLER | TRACK SPOTLIGHT | PROJECTEUR SUR RAIL



**LED 3-Phasen-Schiene-Strahler** direktstrahlend. Leuchte aus Aluminium-Druckguss mit einem Durchmesser von 54 mm und einer Höhe von 75 mm. Durch den modularen Aufbau dieser Strahler-Familie gibt es die Leuchte wahlweise mit einem Abstrahlwinkel von 30° oder 55°. Oberfläche der Leuchte feinstruktur matt pulverbeschichtet ähnlich RAL 9016 weiß oder ähnlich RAL 9005 schwarz. Die Leuchte ist ausgestattet mit einem hochwertigen Dekorring mit einer Auswahl an acht verschiedenen Farben – Oberfläche hochglänzend bzw. matt. Die Leuchte kann mit inTrack-Adapter on/off oder DALI bestellt werden. Farbtemperaturen 2700K, 3000K, 4000K Farbwiedergabe CRI>80 bzw. CRI>90 – MacAdam ≤ 2. Weitere Optionen und Konfigurationen auf Anfrage möglich.

**LED 3-phase track spotlight** direct beam. Luminaire made of die-cast aluminium with a diameter of 54 mm and a height of 75 mm. Due to the modular design of this spotlight family, the luminaire is either available with a beam angle of 30° or 55°. Surface of the luminaire fine structure matt powder coated similar to RAL 9016 white or similar to RAL 9005 black. The luminaire is equipped with a high-quality decoration ring with a choice of eight different colours – surface specular or matt. The luminaire can be ordered with inTrack adapter either on/off or DALI. Colour temperatures 2700K, 3000K, 4000K - colour rendering CRI>80 or CRI>90 - MacAdam ≤ 2. Other options and configurations available upon request.

**Projecteur LED triphasé sur rail** à éclairage direct. Luminaire en aluminium moulé sous pression d'un diamètre de 54 mm et d'une hauteur de 75 mm. Grâce à la structure modulaire de cette famille de projecteurs, le luminaire est disponible au choix avec un angle de rayonnement de 30° ou de 55°. Surface du luminaire à structure fine, revêtement par poudre mat similaire à RAL 9016 blanc ou similaire à RAL 9005 noir. Le luminaire est équipé d'un anneau décoratif de haute qualité avec un choix de huit couleurs différentes - surface brillante ou mate. Le luminaire peut être commandé au choix avec un adaptateur inTrack on/off ou DALI. Températures de couleur 2700K, 3000K, 4000K - Rendu des couleurs CRI>80 ou CRI>90 - MacAdam ≤ 2. Autres options et configurations possibles sur demande.

## ÜBERSICHT | OVERVIEW | VUE D'ENSEMBLE

### TECHNICAL DATA

2700K / 3000K / 4000K

CRI>80 / CRI>90

MacAdam ≤ 2

inTrack Adapter: on-off / DALI

beam angle: 30° / 55°

L80 B10 50.000h



RAL colour of your choice



Contact us for more options...

### HOUSING COLOUR

schwarz | black | *noir*  
RAL 9005



weiß | white | *blanc*  
RAL 9016



### DECORATION RING COLOUR

silber hochglanz | silver specular | *argenté brillant*



gold hochglanz | gold specular | *doré brillant*



silber matt | silver matt | *argenté mat*



bronze hochglanz | bronze specular | *bronze brillant*



schwarz hochglanz | black specular | *noir brillant*



titan hochglanz | titan specular | *titan brillant*



schwarz matt | black matt | *noir mat*



weiß matt | white matt | *blanc mat*



**SCHIENENSTRAHLER „GLOWmini“**  
**TRACK SPOTLIGHT “GLOWmini”**  
**PROJECTEUR SUR RAIL « GLOWmini »**

Bestellbeispiel | Example order | Exemple de commande  
 30°, CRI90, 4000K, **direct**, inTrack Adapter on/off, black, black matt

**GL05T-309401-OOBLB**

1 2 3 4 5 6

<b>1</b>	<b>ABSTRAHLWINKEL</b> BEAM ANGLE ANGLE DE DIFFUSION	
	30°	<b>30</b>
	55°	<b>55</b>

<b>2</b>	<b>FARBWIEDERGABE</b> COLOUR RENDERING RENDU DES COULEURS	
	CRI>80	<b>8</b>
	CRI>90	<b>9</b>

<b>3</b>	<b>FARBTEMPERATUR</b> COLOUR TEMPERATURE TEMPÉRATURE DE COULEUR	
	2700K (CRI>90 only)	<b>27</b>
	3000K	<b>30</b>
	4000K	<b>40</b>

<b>4</b>	<b>LEISTUNG &amp; STEUERUNG</b> OUTPUT & CONTROL SORTIE & CONTRÔLE	
	on/off	<b>OO</b>
	DALI	<b>DD</b>

<b>5</b>	<b>GEHÄUSEFARBE</b> HOUSING COLOUR COULEUR DU BOÎTIER	
	white RAL 9016	<b>WH</b>
	black RAL 9005	<b>BL</b>

<b>6</b>	<b>DEKORRING FARBE</b> DECORATION RING COLOUR BAGUE DÉCORATIVE COULEUR	
	silver specular	<b>S</b>
	silver matt	<b>M</b>
	black specular	<b>N</b>
	black matt	<b>B</b>
	gold specular	<b>G</b>
	bronze specular	<b>C</b>
	titan specular	<b>T</b>
	white matt	<b>W</b>

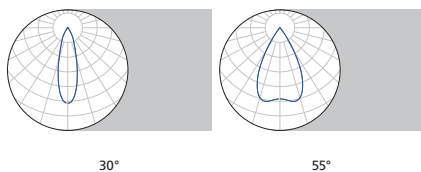
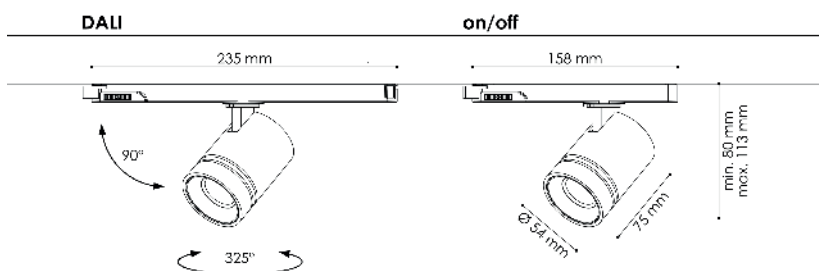

Size [mm]	output [lm] / [W]	output [lm] / [W]	[kg]
Ø 54 x 75	1.261 / 13,5	1.274 / 13,5	0,34

Alle Lumenangaben für 4000K, CRI>80  
 All lumen values for 4000K, CRI>80  
 Toutes les données de lumens pour 4000K, CRI>80

# GLOWsmall

SCHIENENSTRAHLER | TRACK SPOTLIGHT | PROJECTEUR SUR RAIL



**LED 3-Phasen-Schiene-Strahler** direktstrahlend. Leuchte aus Aluminium-Druckguss mit einem Durchmesser von 66 mm und einer Höhe von 83 mm. Durch den modularen Aufbau dieser Strahler-Familie gibt es die Leuchte wahlweise mit einem Abstrahlwinkel von 30° oder 55°. Oberfläche der Leuchte feinstruktur matt pulverbeschichtet ähnlich RAL 9016 weiß oder ähnlich RAL 9005 schwarz. Die Leuchte ist ausgestattet mit einem hochwertigen Dekorring mit einer Auswahl an acht verschiedenen Farben – Oberfläche hochglänzend bzw. matt. Die Leuchte kann mit inTrack-Adapter on/off oder DALI bestellt werden. Farbtemperaturen 2700K, 3000K, 4000K Farbwiedergabe CRI>80 bzw. CRI>90 – MacAdam ≤ 2. Weitere Optionen und Konfigurationen auf Anfrage möglich.

**LED 3-phase track spotlight** direct beam. Luminaire made of die-cast aluminium with a diameter of 66 mm and a height of 83 mm. Due to the modular design of this spotlight family, the luminaire is either available with a beam angle of 30° or 55°. Surface of the luminaire fine structure matt powder coated similar to RAL 9016 white or similar to RAL 9005 black. The luminaire is equipped with a high-quality decoration ring with a choice of eight different colours – surface specular or matt. The luminaire can be ordered with inTrack adapter either on/off or DALI. Colour temperatures 2700K, 3000K, 4000K - colour rendering CRI>80 or CRI>90 - MacAdam ≤ 2. Other options and configurations available upon request.

**Projecteur LED triphasé sur rail** à éclairage direct. Luminaire en aluminium moulé sous pression d'un diamètre de 66 mm et d'une hauteur de 83 mm. Grâce à la structure modulaire de cette famille de projecteurs, le luminaire est disponible au choix avec un angle de rayonnement de 30° ou de 55°. Surface du luminaire à structure fine, revêtement par poudre mat similaire à RAL 9016 blanc ou similaire à RAL 9005 noir. Le luminaire est équipé d'un anneau décoratif de haute qualité avec un choix de huit couleurs différentes - surface brillante ou mate. Le luminaire peut être commandé au choix avec un adaptateur inTrack on/off ou DALI. Températures de couleur 2700K, 3000K, 4000K - Rendu des couleurs CRI>80 ou CRI>90 - MacAdam ≤ 2. Autres options et configurations possibles sur demande.

## ÜBERSICHT | OVERVIEW | VUE D'ENSEMBLE

### TECHNICAL DATA

2700K / 3000K / 4000K

CRI>80 / CRI>90

MacAdam ≤ 2

inTrack Adapter: on-off / DALI

beam angle: 30° / 55°

L80 B10 50.000h



325°



90°



RAL colour of your choice



Contact us for more options...

### HOUSING COLOUR

schwarz | black | *noir*  
RAL 9005



weiß | white | *blanc*  
RAL 9016



### DECORATION RING COLOUR

silber hochglanz | silver specular | *argenté brillant*



gold hochglanz | gold specular | *doré brillant*



silber matt | silver matt | *argenté mat*



bronze hochglanz | bronze specular | *bronze brillant*



schwarz hochglanz | black specular | *noir brillant*



titan hochglanz | titan specular | *titan brillant*



schwarz matt | black matt | *noir mat*



weiß matt | white matt | *blanc mat*



**SCHIENENSTRAHLER „GLOWsmall“**  
**TRACK SPOTLIGHT “GLOWsmall”**  
**PROJECTEUR SUR RAIL « GLOWsmall »**

Bestellbeispiel | Example order | Exemple de commande  
 30°, CRI90, 4000K, **direct**, inTrack Adapter on/off, black, black matt

**GL06T-309401-OOBLB**

1 2 3 4 5 6

<b>1</b>	<b>ABSTRAHLWINKEL</b> BEAM ANGLE ANGLE DE DIFFUSION	
	30°	<b>30</b>
	55°	<b>55</b>

<b>2</b>	<b>FARBWIEDERGABE</b> COLOUR RENDERING RENDU DES COULEURS	
	CRI>80	<b>8</b>
	CRI>90	<b>9</b>

<b>3</b>	<b>FARBTEMPERATUR</b> COLOUR TEMPERATURE TEMPÉRATURE DE COULEUR	
	2700K (CRI>90 only)	<b>27</b>
	3000K	<b>30</b>
	4000K	<b>40</b>

<b>4</b>	<b>LEISTUNG &amp; STEUERUNG</b> OUTPUT & CONTROL SORTIE & CONTRÔLE	
	on/off	<b>OO</b>
	DALI	<b>DD</b>

<b>5</b>	<b>GEHÄUSEFARBE</b> HOUSING COLOUR COULEUR DU BOÎTIER	
	white RAL 9016	<b>WH</b>
	black RAL 9005	<b>BL</b>

<b>6</b>	<b>DEKORRING FARBE</b> DECORATION RING COLOUR BAGUE DÉCORATIVE COULEUR	
	silver specular	<b>S</b>
	silver matt	<b>M</b>
	black specular	<b>N</b>
	black matt	<b>B</b>
	gold specular	<b>G</b>
	bronze specular	<b>C</b>
	titan specular	<b>T</b>
	white matt	<b>W</b>

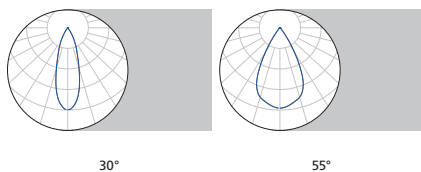
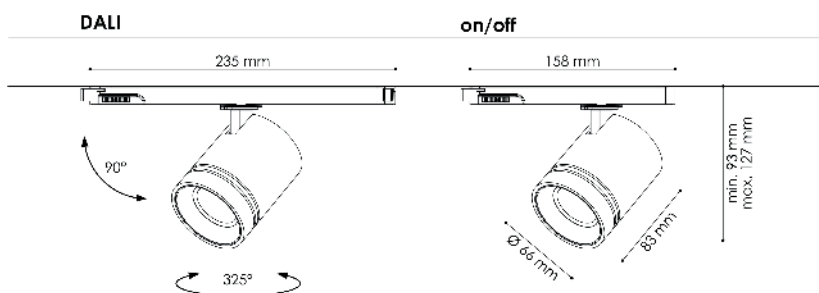

Size [mm]	output [lm] / [W]	output [lm] / [W]	[kg]
Ø 66 x 83	1.772 / 15,5	1.732 / 15,5	0,43

Alle Lumenangaben für 4000K, CRI>80  
 All lumen values for 4000K, CRI>80  
 Toutes les données de lumens pour 4000K, CRI>80

# GLOWmedium

SCHIENENSTRAHLER | TRACK SPOTLIGHT | PROJECTEUR SUR RAIL



**LED 3-Phasen-Schiene-Strahler** direktstrahlend. Leuchte aus Aluminium-Druckguss mit einem Durchmesser von 90 mm und einer Höhe von 102 mm. Durch den modularen Aufbau dieser Strahler-Familie gibt es die Leuchte wahlweise mit einem Abstrahlwinkel von 15°, 24° oder 55°. Oberfläche der Leuchte feinstruktur matt pulverbeschichtet ähnlich RAL 9016 weiß oder ähnlich RAL 9005 schwarz. Die Leuchte ist ausgestattet mit einem hochwertigen Dekorring mit einer Auswahl an acht verschiedenen Farben – Oberfläche hochglänzend bzw. matt. Die Leuchte kann mit inTrack-Adapter on/off oder DALI bestellt werden. Farbtemperaturen 2700K, 3000K, 4000K sowie spezial-COB LEDs für Fashion (3500K), Backwaren, Fleisch & Wurst, Fisch oder Gemüse – Farbwiedergabe CRI>80 oder CRI>90 bzw. basierend auf der spezial COB LED – Mac Adam ≤ 2. Weitere Optionen und Konfigurationen auf Anfrage möglich.

**LED 3-phase track spotlight** direct beam. Luminaire made of die-cast aluminium with a diameter of 90 mm and a height of 102 mm. Due to the modular design of this spotlight family, the luminaire is either available with a beam angle of 15°, 24° or 55°. Surface of the luminaire fine structure matt powder coated similar to RAL 9016 white or similar to RAL 9005 black. The luminaire is equipped with a high-quality decoration ring with a choice of eight different colours – surface specular or matt. The luminaire can be ordered with inTrack adapter either on/off or DALI. Colour temperatures 2700K, 3000K, 4000K as well as special COB LEDs for fashion (3500K), bakery, meat & sausage, fish or vegetables – colour rendering CRI>80 or CRI>90 or based on the CRI of the special COB LED – Mac Adam ≤ 2. Other options and configurations available upon request.

**Projecteur LED triphasé sur rail** à éclairage direct. Luminaire en aluminium moulé sous pression d'un diamètre de 90 mm et d'une hauteur de 102 mm. Grâce à la structure modulaire de cette famille de projecteurs, le luminaire est disponible au choix avec un angle de rayonnement de 15°, 24° ou de 55°. Surface du luminaire à structure fine, revêtement par poudre mat similaire à RAL 9016 blanc ou similaire à RAL 9005 noir. Le luminaire est équipé d'un anneau décoratif de haute qualité avec un choix de huit couleurs différentes – surface brillante ou mate. Le luminaire peut être commandé au choix avec un adaptateur inTrack on/off ou DALI. Températures de couleur 2700K, 3000K, 4000K ainsi que des LED COB spéciales pour la mode (3500K), la boulangerie, la viande et la charcuterie, le poisson ou les légumes – rendu des couleurs IRC>80 ou IRC>90 ou en fonction de l'IRC de la LED COB spéciale – Mac Adam ≤ 2. Autres options et configurations possibles sur demande.

## ÜBERSICHT | OVERVIEW | VUE D'ENSEMBLE

### TECHNICAL DATA

2700K / 3000K / 4000K / many special COBs

CRI>80 / CRI>90 / many special COBs

MacAdam ≤ 2

inTrack Adapter: on-off / DALI

beam angle: 15° / 24° / 55°

L80 B10 50.000h



325°

90°



RAL colour of your choice



Contact us for more options...

### HOUSING COLOUR

schwarz | black | *noir*  
RAL 9005



weiß | white | *blanc*  
RAL 9016



### DECORATION RING COLOUR

silber hochglanz | silver specular | *argenté brillant*



gold hochglanz | gold specular | *doré brillant*



silber matt | silver matt | *argenté mat*



bronze hochglanz | bronze specular | *bronze brillant*



schwarz hochglanz | black specular | *noir brillant*



titan hochglanz | titan specular | *titan brillant*



schwarz matt | black matt | *noir mat*



weiß matt | white matt | *blanc mat*





**SCHIENENSTRAHLER „GLOWmedium“**  
**TRACK SPOTLIGHT “GLOWmedium”**  
**PROJECTEUR SUR RAIL « GLOWmedium »**

Bestellbeispiel | Example order | Exemple de commande  
 15°, CRI90, 4000K, **direct**, inTrack Adapter low output on/off, black, black matt

**GL09T-159401-LOBLB**

1 2 3 4 5 6

1 ABSTRAHLWINKEL BEAM ANGLE ANGLE DE DIFFUSION	
15°	15
24°	24
55°	55

2 FARBWIEDERGABE COLOUR RENDERING RENDU DES COULEURS	
CRI>70 (meat only)	7
CRI>80	8
CRI>90 (fashion CRI>95)	9

3 FARBTEMPERATUR COLOUR TEMPERATURE TEMPÉRATURE DE COULEUR	
2700K (CRI>90 only)	27
3000K	30
fashion 3500K (CRI>95 only)	35
4000K	40
bakery (CRI>90 only)	BA
meat (CRI>70 only)	ME
fish (CRI>80 only)	FI
vegetables (CRI>90 only)	VE

4 LEISTUNG & STEUERUNG OUTPUT & CONTROL SORTIE & CONTRÔLE	
low output on/off	LO
low output DALI	LD
high output on/off	HO
high output DALI	HD

5 GEHÄUSEFARBE HOUSING COLOUR COULEUR DU BOÎTIER	
white RAL 9016	WH
black RAL 9005	BL

6 DEKORRING FARBE DECORATION RING COLOUR BAGUE DÉCORATIVE COULEUR	
silver specular	S
silver matt	M
black specular	N
black matt	B
gold specular	G
bronze specular	C
titan specular	T
white matt	W

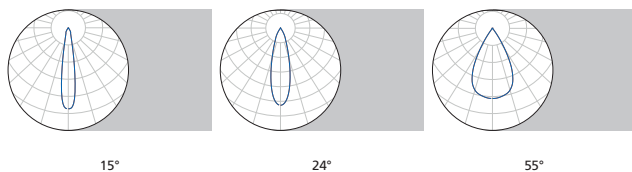
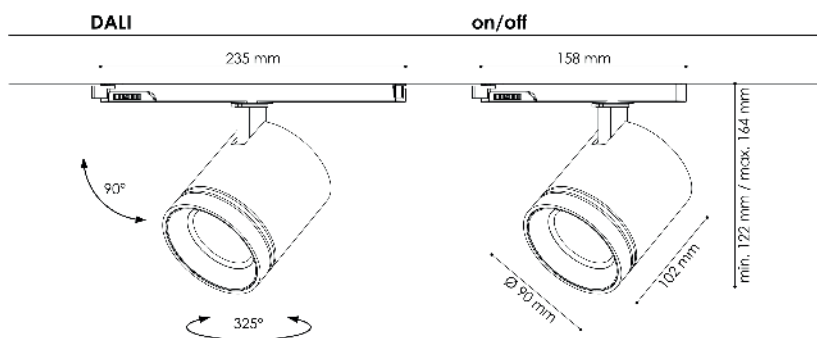

Size [mm]	low output		high output		low output		high output		KG				
	[lm]	[W]	[lm]	[W]	[lm]	[W]	[lm]	[W]					
Ø 90 x 102	1.832	14,9	3.230	28,5	1.865	14,9	3.289	28,5	1.855	14,9	3.271	28,5	0,69

Alle Lumenangaben für 4000K, CRI>80  
 All lumen values for 4000K, CRI>80  
 Toutes les données de lumens pour 4000K, CRI>80

# GLOWlarge

SCHIENENSTRAHLER | TRACK SPOTLIGHT | PROJECTEUR SUR RAIL



**LED 3-Phasen-Schiene-Strahler** direktstrahlend. Leuchte aus Aluminium-Druckguss mit einem Durchmesser von 103 mm und einer Höhe von 109 mm. Durch den modularen Aufbau dieser Strahler-Familie gibt es die Leuchte wahlweise mit einem Abstrahlwinkel von 15°, 24° oder 55°. Oberfläche der Leuchte feinstruktur matt pulverbeschichtet ähnlich RAL 9016 weiß oder ähnlich RAL 9005 schwarz. Die Leuchte ist ausgestattet mit einem hochwertigen Dekorring mit einer Auswahl an acht verschiedenen Farben – Oberfläche hochglänzend bzw. matt. Die Leuchte kann mit inTrack-Adapter on/off oder DALI bestellt werden. Farbtemperaturen 2700K, 3000K, 4000K sowie spezial-COB LEDs für Fashion (3500K), Backwaren, Fleisch & Wurst, Fisch oder Gemüse – Farbwiedergabe CRI>80 oder CRI>90 bzw. basierend auf der spezial COB LED – Mac Adam ≤ 2. Weitere Optionen und Konfigurationen auf Anfrage möglich.

**LED 3-phase track spotlight** direct beam. Luminaire made of die-cast aluminium with a diameter of 103 mm and a height of 109 mm. Due to the modular design of this spotlight family, the luminaire is either available with a beam angle of 15°, 24° or 55°. Surface of the luminaire fine structure matt powder coated similar to RAL 9016 white or similar to RAL 9005 black. The luminaire is equipped with a high-quality decoration ring with a choice of eight different colours – surface specular or matt. The luminaire can be ordered with inTrack adapter either on/off or DALI. Colour temperatures 2700K, 3000K, 4000K as well as special COB LEDs for fashion (3500K), bakery, meat & sausage, fish or vegetables – colour rendering CRI>80 or CRI>90 or based on the CRI of the special COB LED – Mac Adam ≤ 2. Other options and configurations available upon request.

**Projecteur LED triphasé sur rail** à éclairage direct. Luminaire en aluminium moulé sous pression d'un diamètre de 103 mm et d'une hauteur de 109 mm. Grâce à la structure modulaire de cette famille de projecteurs, le luminaire est disponible au choix avec un angle de rayonnement de 15°, 24° ou de 55°. Surface du luminaire à structure fine, revêtement par poudre mat similaire à RAL 9016 blanc ou similaire à RAL 9005 noir. Le luminaire est équipé d'un anneau décoratif de haute qualité avec un choix de huit couleurs différentes – surface brillante ou mate. Le luminaire peut être commandé au choix avec un adaptateur inTrack on/off ou DALI. Températures de couleur 2700K, 3000K, 4000K ainsi que des LED COB spéciales pour la mode (3500K), la boulangerie, la viande et la charcuterie, le poisson ou les légumes – rendu des couleurs IRC>80 ou IRC>90 ou en fonction de l'IRC de la LED COB spéciale – Mac Adam ≤ 2. Autres options et configurations possibles sur demande.

## ÜBERSICHT | OVERVIEW | VUE D'ENSEMBLE

### TECHNICAL DATA

2700K / 3000K / 4000K / many special COBs

CRI>80 / CRI>90 / many special COBs

MacAdam ≤ 2

inTrack Adapter: on-off / DALI

beam angle: 15° / 24° / 55°

L80 B10 50.000h



RAL colour of your choice



Contact us for more options...

### HOUSING COLOUR

schwarz | black | *noir*  
RAL 9005



weiß | white | *blanc*  
RAL 9016



### DECORATION RING COLOUR

silber hochglanz | silver specular | *argenté brillant*



gold hochglanz | gold specular | *doré brillant*



silber matt | silver matt | *argenté mat*



bronze hochglanz | bronze specular | *bronze brillant*



schwarz hochglanz | black specular | *noir brillant*



titan hochglanz | titan specular | *titan brillant*



schwarz matt | black matt | *noir mat*



weiß matt | white matt | *blanc mat*



**SCHIENENSTRAHLER „GLOWlarge“**  
**TRACK SPOTLIGHT “GLOWlarge”**  
**PROJECTEUR SUR RAIL « GLOWlarge »**

Bestellbeispiel | Example order | Exemple de commande  
 15°, CRI90, 4000K, **direct**, inTrack Adapter low output on/off, black, black matt

**GL10T-159401-LOBLB**

1 2 3 4 5 6

<b>1</b>	<b>ABSTRAHLWINKEL</b> BEAM ANGLE ANGLE DE DIFFUSION	
	15°	<b>15</b>
	24°	<b>24</b>
	55°	<b>55</b>

<b>2</b>	<b>FARBWIEDERGABE</b> COLOUR RENDERING RENDU DES COULEURS	
	CRI>70 (meat only)	<b>7</b>
	CRI>80	<b>8</b>
	CRI>90 (fashion CRI>95)	<b>9</b>

<b>3</b>	<b>FARBTEMPERATUR</b> COLOUR TEMPERATURE TEMPÉRATURE DE COULEUR	
	2700K (CRI>90 only)	<b>27</b>
	3000K	<b>30</b>
	fashion 3500K (CRI>95 only)	<b>35</b>
	4000K	<b>40</b>
	bakery (CRI>90 only)	<b>BA</b>
	meat (CRI>70 only)	<b>ME</b>
	fish (CRI>80 only)	<b>FI</b>
	vegetables (CRI>90 only)	<b>VE</b>

<b>4</b>	<b>LEISTUNG &amp; STEUERUNG</b> OUTPUT & CONTROL SORTIE & CONTRÔLE	
	low output on/off	<b>LO</b>
	low output DALI	<b>LD</b>
	high output on/off	<b>HO</b>
	high output DALI	<b>HD</b>

<b>5</b>	<b>GEHÄUSEFARBE</b> HOUSING COLOUR COULEUR DU BOÎTIER	
	white RAL 9016	<b>WH</b>
	black RAL 9005	<b>BL</b>

<b>6</b>	<b>DEKORRING FARBE</b> DECORATION RING COLOUR BAGUE DÉCORATIVE COULEUR	
	silver specular	<b>S</b>
	silver matt	<b>M</b>
	black specular	<b>N</b>
	black matt	<b>B</b>
	gold specular	<b>G</b>
	bronze specular	<b>C</b>
	titan specular	<b>T</b>
	white matt	<b>W</b>

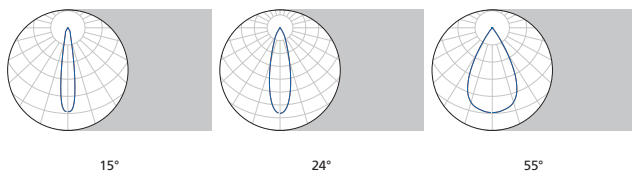
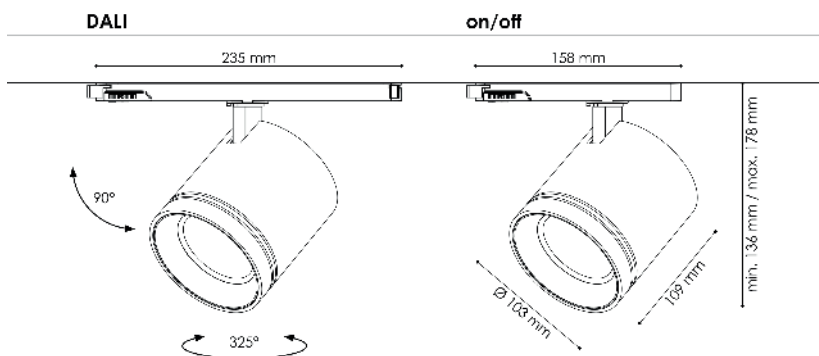

Size [mm]	low output [lm] / [W]	high output [lm] / [W]	low output [lm] / [W]	high output [lm] / [W]	low output [lm] / [W]	high output [lm] / [W]	[kg]
Ø 103 x 109	2.523 / 18,8	4.185 / 34,3	2.505 / 18,8	4.155 / 34,3	2.371 / 18,8	3.932 / 34,3	0,85

Alle Lumenangaben für 4000K, CRI>80  
 All lumen values for 4000K, CRI>80  
 Toutes les données de lumens pour 4000K, CRI>80

# GLOWultra

SCHIENENSTRAHLER | TRACK SPOTLIGHT | PROJECTEUR SUR RAIL



**LED 3-Phasen-Schiene-Strahler** direktstrahlend. Leuchte aus Aluminium-Druckguss mit einem Durchmesser von 123 mm und einer Höhe von 124 mm. Durch den modularen Aufbau dieser Strahler-Familie gibt es die Leuchte wahlweise mit einem Abstrahlwinkel von 15°, 24° oder 55°. Oberfläche der Leuchte feinstruktur matt pulverbeschichtet ähnlich RAL 9016 weiß oder ähnlich RAL 9005 schwarz. Die Leuchte ist ausgestattet mit einem hochwertigen Dekorring mit einer Auswahl an acht verschiedenen Farben – Oberfläche hochglänzend bzw. matt. Die Leuchte kann mit inTrack-Adapter on/off oder DALI bestellt werden. Farbtemperaturen 2700K, 3000K, 4000K sowie spezial-COB LEDs für Fashion (3500K), Backwaren, Fleisch & Wurst, Fisch oder Gemüse – Farbwiedergabe CRI>80 oder CRI>90 bzw. basierend auf der spezial COB LED – Mac Adam ≤ 2. Weitere Optionen und Konfigurationen auf Anfrage möglich.

**LED 3-phase track spotlight** direct beam. Luminaire made of die-cast aluminium with a diameter of 123 mm and a height of 124 mm. Due to the modular design of this spotlight family, the luminaire is either available with a beam angle of 15°, 24° or 55°. Surface of the luminaire fine structure matt powder coated similar to RAL 9016 white or similar to RAL 9005 black. The luminaire is equipped with a high-quality decoration ring with a choice of eight different colours – surface specular or matt. The luminaire can be ordered with inTrack adapter either on/off or DALI. Colour temperatures 2700K, 3000K, 4000K as well as special COB LEDs for fashion (3500K), bakery, meat & sausage, fish or vegetables – colour rendering CRI>80 or CRI>90 or based on the CRI of the special COB LED – Mac Adam ≤ 2. Other options and configurations available upon request.

**Projecteur LED triphasé sur rail** à éclairage direct. Luminaire en aluminium moulé sous pression d'un diamètre de 123 mm et d'une hauteur de 124 mm. Grâce à la structure modulaire de cette famille de projecteurs, le luminaire est disponible au choix avec un angle de rayonnement de 15°, 24° ou de 55°. Surface du luminaire à structure fine, revêtement par poudre mat similaire à RAL 9016 blanc ou similaire à RAL 9005 noir. Le luminaire est équipé d'un anneau décoratif de haute qualité avec un choix de huit couleurs différentes – surface brillante ou mate. Le luminaire peut être commandé au choix avec un adaptateur inTrack on/off ou DALI. Températures de couleur 2700K, 3000K, 4000K ainsi que des LED COB spéciales pour la mode (3500K), la boulangerie, la viande et la charcuterie, le poisson ou les légumes – rendu des couleurs IRC>80 ou IRC>90 ou en fonction de l'IRC de la LED COB spéciale – Mac Adam ≤ 2. Autres options et configurations possibles sur demande.

## ÜBERSICHT | OVERVIEW | VUE D'ENSEMBLE

### TECHNICAL DATA

2700K / 3000K / 4000K / many special COBs

CRI>80 / CRI>90 / many special COBs

MacAdam ≤ 2

inTrack Adapter: on-off / DALI

beam angle: 15° / 24° / 55°

L80 B10 50.000h



RAL colour of your choice



Contact us for more options...

### HOUSING COLOUR

schwarz | black | *noir*  
RAL 9005



weiß | white | *blanc*  
RAL 9016



### DECORATION RING COLOUR

silber hochglanz | silver specular | *argenté brillant*



gold hochglanz | gold specular | *doré brillant*



silber matt | silver matt | *argenté mat*



bronze hochglanz | bronze specular | *bronze brillant*



schwarz hochglanz | black specular | *noir brillant*



titan hochglanz | titan specular | *titan brillant*



schwarz matt | black matt | *noir mat*



weiß matt | white matt | *blanc mat*



**SCHIENENSTRAHLER „GLOWultra“**  
**TRACK SPOTLIGHT “GLOWultra”**  
**PROJECTEUR SUR RAIL « GLOWultra »**

Bestellbeispiel | Example order | Exemple de commande  
 15°, CRI90, 4000K, **direct**, inTrack Adapter low output on/off, black, black matt

**GL12T-159401-LOBLB**

1 2 3 4 5 6

1 ABSTRAHLWINKEL BEAM ANGLE ANGLE DE DIFFUSION		
15°		<b>15</b>
24°		<b>24</b>
55°		<b>55</b>

2 FARBWIEDERGABE COLOUR RENDERING RENDU DES COULEURS		
CRI>70 (meat only)		<b>7</b>
CRI>80		<b>8</b>
CRI>90 (fashion CRI>95)		<b>9</b>

3 FARBTEMPERATUR COLOUR TEMPERATURE TEMPÉRATURE DE COULEUR		
2700K (CRI>90 only)		<b>27</b>
3000K		<b>30</b>
👤 fashion 3500K (CRI>95 only)		<b>35</b>
4000K		<b>40</b>
👨‍🍳 bakery (CRI>90 only)		<b>BA</b>
🥩 meat (CRI>70 only)		<b>ME</b>
🐟 fish (CRI>80 only)		<b>FI</b>
🥕 vegetables (CRI>90 only)		<b>VE</b>

4 LEISTUNG & STEUERUNG OUTPUT & CONTROL SORTIE & CONTRÔLE		
low output on/off		<b>LO</b>
low output DALI		<b>LD</b>
high output on/off		<b>HO</b>
high output DALI		<b>HD</b>

5 GEHÄUSEFARBE HOUSING COLOUR COULEUR DU BOÎTIER		
white RAL 9016		<b>WH</b>
black RAL 9005		<b>BL</b>

6 DEKORRING FARBE DECORATION RING COLOUR BAGUE DÉCORATIVE COULEUR		
silver specular		<b>S</b>
silver matt		<b>M</b>
black specular		<b>N</b>
black matt		<b>B</b>
gold specular		<b>G</b>
bronze specular		<b>C</b>
titan specular		<b>T</b>
white matt		<b>W</b>

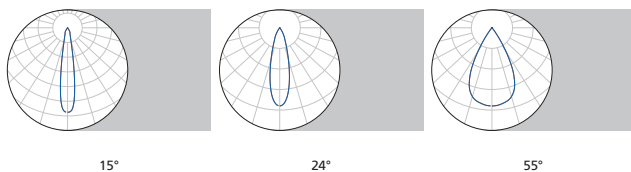
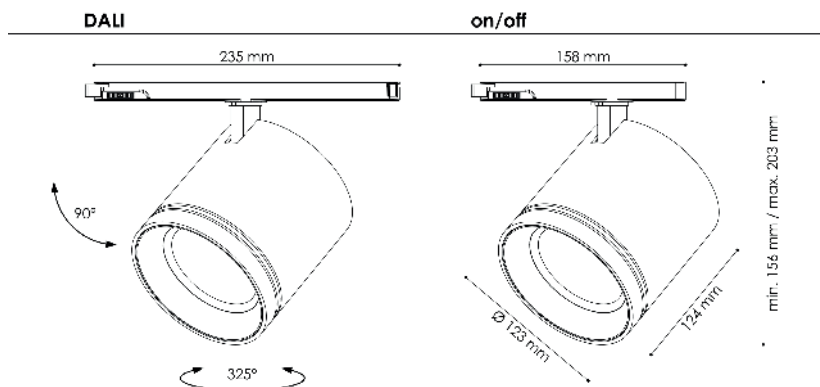

Size [mm]	low output [lm] / [W]		high output [lm] / [W]		low output [lm] / [W]		high output [lm] / [W]		👤 kg				
	Ø 123 x 124	2.814	20,9	4.834	40,4	2.761	20,9	4.742		40,4	2.806	20,9	4.820

Alle Lumenangaben für 4000K, CRI>80  
 All lumen values for 4000K, CRI>80  
 Toutes les données de lumens pour 4000K, CRI>80

# GLOWgu10

SCHIENENSTRAHLER | TRACK SPOTLIGHT | PROJECTEUR SUR RAIL



**GU10 3-Phasen-Schiene-Strahler** direktstrahlend inkl. GU10 Leuchtmittel. Leuchte aus Aluminium-Druckguss mit einem Durchmesser von 70 mm und einer Höhe von 110 mm. Die GU10 Variante dieser Strahler Familie ist erhältlich mit einem Abstrahlwinkel von 32°. Oberfläche der Leuchte feinstruktur matt pulverbeschichtet ähnlich RAL 9016 weiß oder ähnlich RAL 9005 schwarz. Die Leuchte ist ausgestattet mit einem hochwertigen Dekorring mit einer Auswahl an acht verschiedenen Farben – Oberfläche hochglänzend bzw. matt. Die Leuchte wird mit einem on/ off 3-Phasen-Schiene Adapter geliefert. Farbtemperaturen 2700K, 3000K, 4000K Farbwiedergabe CRI>80 Mac Adam ≤ 3. Weitere Optionen und Konfigurationen auf Anfrage möglich.

**GU10 3-phase track spotlight** direct beam incl. GU10 bulb. Luminaire made of die-cast aluminium with a diameter of 70 mm and a height of 110 mm. The GU10 version of this spotlight family is available with a beam angle of 32°. Surface of the luminaire fine structure matt powder coated similar to RAL 9016 white or similar to RAL 9005 black. The luminaire is equipped with a high-quality decoration ring with a choice of eight different colours – surface specular or matt. The luminaire is supplied with an on/off 3-phase track adapter. Colour temperatures 2700K, 3000K, 4000K - colour rendering CRI>80 - Mac Adam ≤ 3. Other options and configurations available upon request.

**Projecteur GU10 triphasé sur rail** à éclairage direct incl. Une lampe GU10. Luminaire en aluminium moulé sous pression d'un diamètre de 70 mm et d'une hauteur de 110 mm. La version GU10 de cette famille de projecteurs est disponible avec un angle de rayonnement de 32°. Surface du luminaire à structure fine, revêtement par poudre mat similaire à RAL 9016 blanc ou similaire à RAL 9005 noir. Le luminaire est équipé d'un anneau décoratif de haute qualité avec un choix de huit couleurs différentes - surface brillante ou mate. Le luminaire est fourni avec un adaptateur triphasé on/off. Températures de couleur 2700K, 3000K, 4000K - Rendu des couleurs CRI>80 - Mac Adam ≤ 3. Autres options et configurations possibles sur demande.

## ÜBERSICHT | OVERVIEW | VUE D'ENSEMBLE

### TECHNICAL DATA

2700K / 3000K / 4000K

CRI>80

MacAdam ≤ 3

inkl. Adapter: on-off

beam angle: 32°



RAL colour of your choice



Contact us for more options...

### HOUSING COLOUR

schwarz | black | *noir*  
RAL 9005



weiß | white | *blanc*  
RAL 9016



### DECORATION RING COLOUR

silber hochglanz | silver specular | *argenté brillant*



gold hochglanz | gold specular | *doré brillant*



silber matt | silver matt | *argenté mat*



bronze hochglanz | bronze specular | *bronze brillant*



schwarz hochglanz | black specular | *noir brillant*



titan hochglanz | titan specular | *titan brillant*



schwarz matt | black matt | *noir mat*



weiß matt | white matt | *blanc mat*



**SCHIENENSTRAHLER „GLOWGU10“**  
 TRACK SPOTLIGHT "GLOWGU10"  
 PROJECTEUR SUR RAIL « GLOWGU10 »

Bestellbeispiel | Example order | Exemple de commande  
 32°, CRI>80, 3000K, direct, 3-PHS-adapter on/off, black, black matt

**GL07T-108301-00BLB**

1 2 3

1 FARBTEMPERATUR COLOUR TEMPERATURE TEMPÉRATURE DE COULEUR	
2700K	27
3000K	30
4000K	40

2 GEHÄUSEFARBE HOUSING COLOUR COULEUR DU BOÎTIER	
white RAL 9016	WH
black RAL 9005	BL

3 DEKORRING FARBE DECORATION RING COLOUR BAGUE DÉCORATIVE COULEUR	
silver specular	S
silver matt	M
black specular	N
black matt	B
gold specular	G
bronze specular	C
titan specular	T
white matt	W

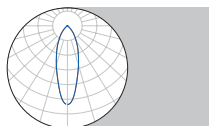
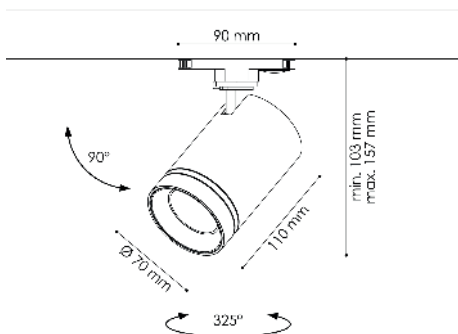

32°

Size [mm]	output [lm] / [W]	 [kg]
Ø 70 x 110	655 / 6,5	0,45

Alle Lumenangaben für 4000K, CRI>80  
 All lumen values for 4000K, CRI>80  
 Toutes les données de lumens pour 4000K, CRI>80





**LED 3-Phasenschienen-Strahler** direktstrahlend. Leuchte aus Aluminium-Druckguss mit einem Durchmesser von 55 mm und einer Höhe von 150 mm. Durch den modularen Aufbau dieser Strahler-Familie gibt es die Leuchte wahlweise mit einem Abstrahlwinkel von 18°, 36° oder 50°. Oberfläche der Leuchte feinstruktur matt pulverbeschichtet ähnlich RAL 9016 weiß oder ähnlich RAL 9005 schwarz. Dekorring des Strahlers schwarz matt. Die Leuchte kann wahlweise mit inTrack-Adapter on/off oder DALI bestellt werden. Farbtemperaturen 2700K, 3000K oder 4000K – Farbwiedergabe CRI>90 – Mac Adam ≤3. Weitere Optionen und Konfigurationen auf Anfrage möglich.

**LED 3-phase track spotlight** direct beam. Luminaire made of die-cast aluminium with a diameter of 55 mm and a height of 150 mm. Due to the modular design of this spotlight family, the luminaire is either available with a beam angle of 18°, 36° or 50°. Surface of the luminaire fine structure matt powder coated similar to RAL 9016 white or similar to RAL 9005 black. Decoration ring of the spotlight matt black. The luminaire can be ordered with inTrack adapter either on/off or DALI. Colour temperatures 2700K, 3000K or 4000K – colour rendering CRI>90 – Mac Adam ≤3. Further options and configurations available on request.

**Projecteur LED triphasé sur rail** à éclairage direct. Luminaire en aluminium moulé sous pression d'un diamètre de 55 mm et d'une hauteur de 150 mm. Grâce à la structure modulaire de cette famille de projecteurs, le luminaire est disponible au choix avec un angle de rayonnement de 18°, 36° ou 50°. Surface du luminaire à structure fine, revêtement par poudre mat similaire à RAL 9016 blanc ou similaire à RAL 9005 noir. Anneau décoratif du projecteur noir mat. Le luminaire peut être commandé au choix avec un adaptateur inTrack on/off ou DALI. Températures de couleur 2700K, 3000K ou 4000K - Rendu des couleurs CRI>90 - Mac Adam ≤3. Autres options et configurations possibles sur demande.

## ÜBERSICHT | OVERVIEW | VUE D'ENSEMBLE

### TECHNICAL DATA

2700K / 3000K / 4000K

CRI>90

MacAdam ≤ 3

inTrack adapter: on-off / DALI

beam angle: 18° / 36° / 50°

L80 B10 50.000h



230V AC



LED



>50,000h



3 SDCM



IP 20



335°



90°



CE



UKCA



Contact us for more options...

### HOUSING COLOUR

schwarz | black | noir  
RAL 9005



weiß | white | blanc  
RAL 9016



### DECORATION RING

schwarz matt | black matt | noir mat



SCHIENENSTRAHLER „tracks“  
 TRACK SPOTLIGHT “tracks”  
 PROJECTEUR SUR RAIL « trackS »

Bestellbeispiel | Example order | Exemple de commande  
 36°, CRI>90, 4000K, direct, inTrack adapter on/off, black, black

**TS55T-369401-OOBLB**

1 2 3 4

1 ABSTRAHLWINKEL BEAM ANGLE ANGLE DE DIFFUSION	
18°	18
36°	36
50°	50

2 FARBTEMPERATUR COLOUR TEMPERATURE TEMPÉRATURE DE COULEUR	
2700K	27
3000K	30
4000K	40

3 LEISTUNG & STEUERUNG OUTPUT & CONTROL SORTIE & CONTRÔLE	
on/off	OO
DALI (Stucchi, ONEtrack/Global)	DD

4 GEHÄUSEFARBE HOUSING COLOUR COULEUR DU BOÎTIER	
white RAL 9016	WH
black RAL 9005	BL

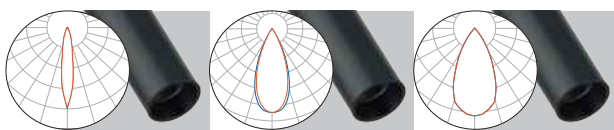
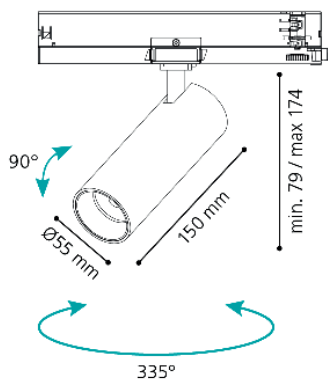

Size [mm]	output [lm] / [W]	output [lm] / [W]	output [lm] / [W]	 [kg]
trackS	1.202 / 15,4	1.293 / 15,4	1.309 / 15,4	1,1

Alle Lumenangaben für 4000K  
 All lumen values for 4000K  
 Toutes les données de lumens pour 4000K



**LED 3-Phasen-Schienen-Strahler** direktstrahlend. Leuchte aus Aluminium-Druckguss mit einem Durchmesser von 72 mm und einer Höhe von 150 mm. Durch den modularen Aufbau dieser Strahler-Familie gibt es die Leuchte wahlweise mit einem Abstrahlwinkel von 20° oder 55°. Oberfläche der Leuchte feinstruktur matt pulverbeschichtet ähnlich RAL 9016 weiß oder ähnlich RAL 9005 schwarz. Dekorring des Strahlers schwarz matt. Die Leuchte kann wahlweise mit inTrack-Adapter on/off oder DALI bestellt werden. Farbtemperaturen 2700K, 3000K, 4000K sowie spezial-COB LEDs für Fashion (3250K), Backwaren, Fleisch, Wurst, Fisch oder Gemüse – Farbwiedergabe CRI>90 bzw. CRI>95 für Fashion – Mac Adam ≤3. Weitere Optionen und Konfigurationen auf Anfrage möglich.

**LED 3-phase track spotlight** direct beam. Luminaire made of die-cast aluminium with a diameter of 72 mm and a height of 150 mm. Due to the modular design of this spotlight family, the luminaire is either available with a beam angle of 20° or 55°. Surface of the luminaire fine structure matt powder coated similar to RAL 9016 white or similar to RAL 9005 black. Decoration ring of the spotlight black matt. The luminaire can be ordered with inTrack adapter either on/off or DALI. Colour temperatures 2700K, 3000K, 4000K as well as special COB LEDs for fashion (3250K), bakery, meat, sausage, fish or vegetables - colour rendering CRI>90 or CRI>95 for fashion - Mac Adam ≤3. Other options and configurations available upon request.

**Projecteur LED triphasé sur rail** à éclairage direct. Luminaire en aluminium moulé sous pression d'un diamètre de 72 mm et d'une hauteur de 150 mm. Grâce à la structure modulaire de cette famille de projecteurs, le luminaire est disponible au choix avec un angle de rayonnement de 20° ou de 55°. Surface du luminaire à structure fine, revêtement par poudre mat similaire à RAL 9016 blanc ou similaire à RAL 9005 noir. Anneau décoratif du projecteur noir mat. Le luminaire peut être commandé au choix avec un adaptateur inTrack on/off ou DALI. Températures de couleur 2700K, 3000K, 4000K ainsi que LED COB spéciales pour la mode (3250K) et l'alimentaire - Rendu des couleurs CRI>90 ou CRI>95 pour la mode - Mac Adam ≤3. Autres options et configurations possibles sur demande

## ÜBERSICHT | OVERVIEW | VUE D'ENSEMBLE

### TECHNICAL DATA

2700K / 3000K / 4000K / many special COBs

CRI>90 / CRI>95 (fashion)

MacAdam ≤ 3

inTrack adapter: on-off / DALI

beam angle: 20° / 55°

L80 B10 50.000h



230V AC



LED



>50,000h



3 SDCM



IP 20



335°



90°



CE



UKCA



Contact us for more options...

### HOUSING COLOUR

schwarz | black | noir  
RAL 9005



weiß | white | blanc  
RAL 9016



### DECORATION RING

schwarz matt | black matt | noir mat



**SCHIENENSTRAHLER „trackM“**  
**TRACK SPOTLIGHT “trackM”**  
**PROJECTEUR SUR RAIL « trackM »**

Bestellbeispiel | Example order | Exemple de commande  
 20°, CRI>90, 4000K, direct, inTrack adapter on/off, black, black

**TM72T-209401-OOBLB**

1 2 3 4

1 ABSTRAHLWINKEL BEAM ANGLE ANGLE DE DIFFUSION	
20°	20
55°	55

2 FARBTEMPERATUR COLOUR TEMPERATURE TEMPÉRATURE DE COULEUR	
2700K	27
3000K	30
fashion 3500K (CRI>95)	35
4000K	40
bakery	BA
meat	ME
sausage	SA
fish	FI
vegetables	VE

3 LEISTUNG & STEUERUNG OUTPUT & CONTROL SORTIE & CONTRÔLE	
on/off	OO
DALI (Stucchi, ONEtrack/Global)	DD

4 GEHÄUSEFARBE HOUSING COLOUR COULEUR DU BÔÎTIER	
white RAL 9016	WH
black RAL 9005	BL

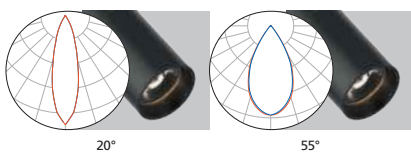
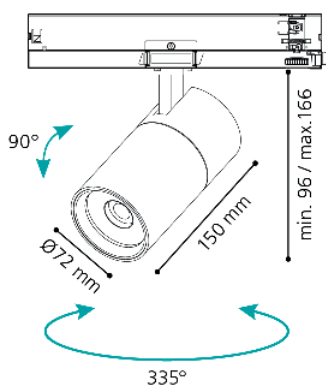

Size [mm]	output [lm] / [W]	output [lm] / [W]	[kg]
trackM	2.100 / 26,6	2.050 / 26,6	1,5

Alle Lumenangaben für 4000K  
 All lumen values for 4000K  
 Toutes les données de lumens pour 4000K

# LINE50

SCHIENENSTRAHLER | TRACK SPOTLIGHT | PROJECTEUR SUR RAIL



**LED 3-Phasen Schienenleuchte** direktstrahlend. Lichtkanal aus Aluminium-Strangpressprofil mit einer Breite von 50 mm. Fertigung der Leuchtenlänge millimetergenau auf Kundenwunsch möglich. Oberfläche der Leuchte feinstrukturiert matt pulverbeschichtet ähnlich RAL 9016 weiß, RAL 9006 silber oder RAL 9005 schwarz – auf Anfrage in RAL nach Wahl. Diffusor wahlweise in PMMA opal oder PMMA klar mit eingeschobener mikroprismatischer Platte für eine reduzierte Leuchtdichte (UGR<19). Der LED-Treiber ist im Leuchtgehäuse integriert – wahlweise als on/off oder DALI-Variante. Farbtemperaturen 2700K, 3000K oder 4000K – Farbwiedergabe CRI>80 oder CRI>90 – Mac Adam ≤3. Weitere Steuerungsoptionen oder Lichtfarben auf Anfrage erhältlich. Außerdem ist die Integration vieler Komponenten, wie beispielsweise Notlicht oder Sensortechnologie, sowie eine Vielzahl weiterer Optionen möglich.

**LED 3-phase track luminaire** with direct beam. Light channel made of extruded aluminium profile with a width of 50 mm. Luminaire length can be manufactured to the exact millimetre on customer request. Surface of the luminaire fine structure matt powder coated similar to RAL 9016 white, RAL 9006 silver or RAL 9005 black - on request in RAL of choice. Diffuser either in PMMA opal or PMMA clear with inserted microprismatic plate for reduced luminance (UGR<19). The LED driver is integrated in the luminaire housing - either as on/off or DALI version. Colour temperatures 2700K, 3000K or 4000K - colour rendering CRI>80 or CRI>90 - Mac Adam ≤3. Further control options or light colours available on request. In addition, the integration of many components, such as emergency lighting or sensor technology, as well as a variety of other options is possible.

**Luminaire LED triphasé sur rail** à éclairage direct. Canal lumineux en profilé d'aluminium extrudé d'une largeur de 50 mm. Fabrication de la longueur du luminaire au millimètre près possible sur demande du client. Surface du luminaire à structure fine, revêtement par poudre mat similaire à RAL 9016 blanc, RAL 9006 argent ou RAL 9005 noir - sur demande en RAL au choix. Diffuseur au choix en PMMA opale ou PMMA transparent avec plaque microprismatique insérée pour un éblouissement réduit (UGR<19). Le pilote LED est intégré dans le boîtier du luminaire - au choix sous forme de variante on/off ou DALI. Températures de couleur 2700K, 3000K ou 4000K - Rendu des couleurs CRI>80 ou CRI>90 - Mac Adam ≤3. Autres options de commande ou couleurs de lumière disponibles sur demande. En outre, l'intégration de nombreux composants, tels que l'éclairage de secours ou la technologie de détection, une multitude d'autres options sont possibles.

## ÜBERSICHT | OVERVIEW | VUE D'ENSEMBLE

### TECHNICAL DATA

2700K / 3000K / 4000K

CRI>80 / CRI>90

MacAdam ≤ 3

up to 122 lm/W, up to 2.766lm/m

on-off / DALI

direct

opal / microprism (UGR <19)

L80 B10 50.000h

### HOUSING COLOUR

schwarz | black | noir  
RAL 9005

silber | silver | argent  
RAL 9006

weiß | white | blanc  
RAL 9016



RAL colour of your choice



Integration of Multisensor



Integration of emergency light



Contact us for more options...

**SCHIENENSTRAHLER „LINE50“**  
**TRACK SPOTLIGHT „LINE50“**  
**PROJECTEUR SUR RAIL « LINE50 »**

Bestellbeispiel | Example order | Exemple de commande  
 974 mm, CRI90, 4000K, **direct**, low output on/off, black, microprism

**LI50T-099401-LOBLM**

1 2 3 4 5 6

**1** LÄNGE  
 LENGTH  
 LONGEUR

614 mm	<b>06</b>
974 mm	<b>09</b>
1.214 mm	<b>12</b>
1.454 mm	<b>14</b>

**2** FARBWIEDERGABE  
 COLOUR RENDERING  
 RENDU DES COULEURS

CRI>80	<b>8</b>
CRI>90	<b>9</b>

**3** FARBTEMPERATUR  
 COLOUR TEMPERATURE  
 TEMPÉRATURE DE COULEUR

2700K (CRI90 only)	<b>27</b>
3000K	<b>30</b>
4000K	<b>40</b>

**4** LEISTUNG & STEUERUNG  
 OUTPUT & CONTROL  
 SORTIE & CONTRÔLE

low output on/off	<b>LO</b>
low output DALI	<b>LD</b>
high output on/off	<b>HO</b>
high output DALI	<b>HD</b>

**5** GEHÄUSEFARBE  
 HOUSING COLOUR  
 COULEUR DU BOÎTIER

silver RAL 9006	<b>SI</b>
white RAL 9016	<b>WH</b>
black RAL 9005	<b>BL</b>

**6** ABDECKUNG  
 COVER  
 COUVERTURE

opal	<b>O</b>
microprism	<b>M</b>

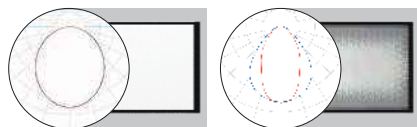
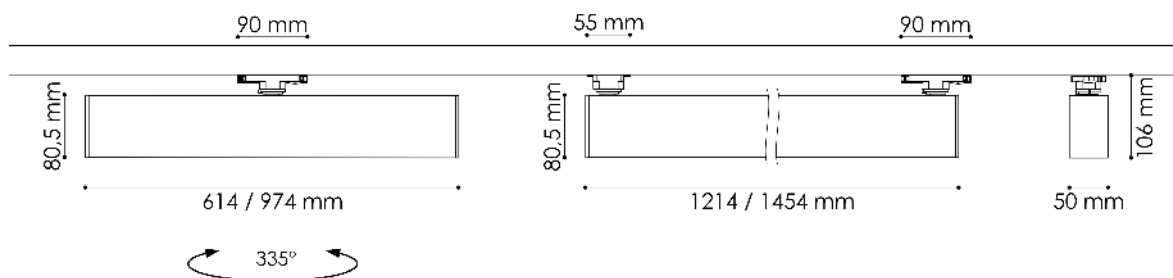

opal  
 direct

microprism  
 direct

direct

Size [mm]	low output [lm] / [W]	high output [lm] / [W]	low output [lm] / [W]	high output [lm] / [W]	 [kg]
614	909 / 8,8	1.731 / 16,3	826 / 8,8	1.581 / 16,3	1,5
974	1.455 / 13,0	2.770 / 25,0	1.321 / 13,0	2.530 / 25,0	2,3
1.214	1.817 / 16,3	3.463 / 30,0	1.652 / 16,3	3.162 / 30,0	2,9
1.454	2.182 / 18,5	4.156 / 35,8	1.982 / 18,5	3.794 / 35,8	3,5

Alle Lumenangaben für 4000K, CRI>80, Microprisma ohne Opalfolie  
 All lumen values for 4000K, CRI>80, microprism without opal foil  
 Toutes les données de lumens pour 4000K, CRI>80, microprisme sans feuille opal

# officeLINE50

SCHIENENSTRAHLER | TRACK SPOTLIGHT | PROJECTEUR SUR RAIL

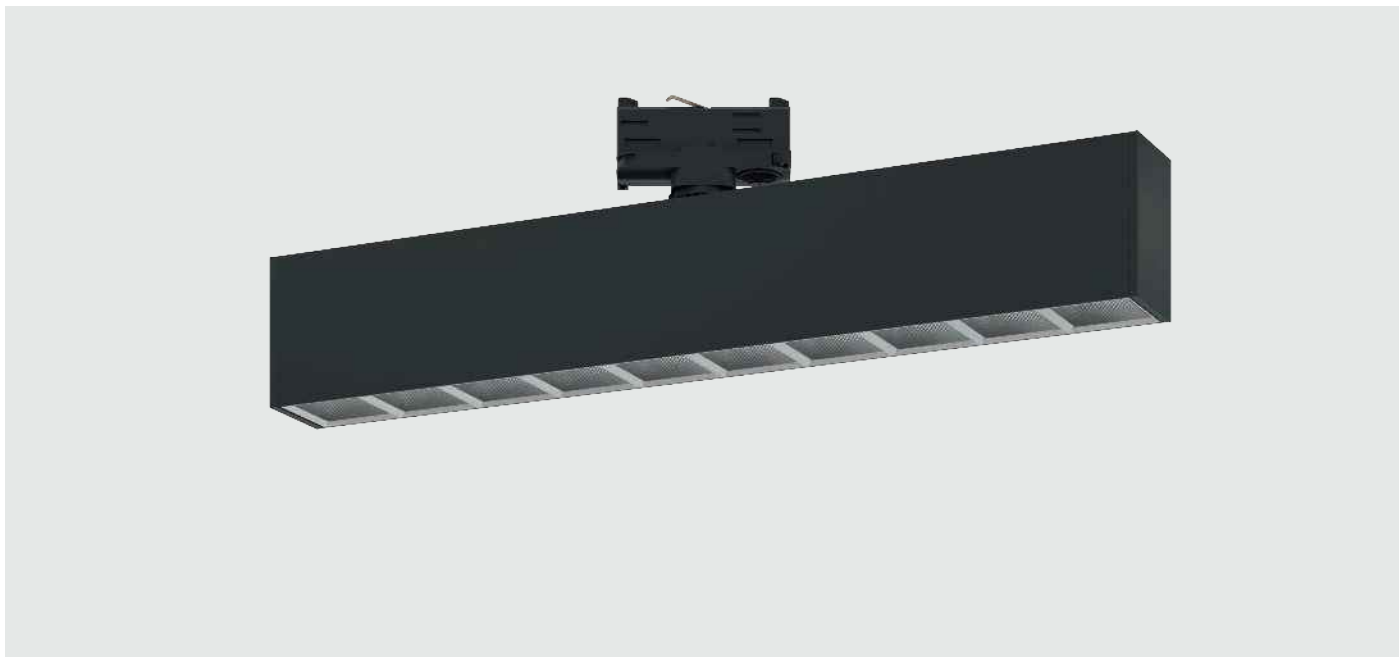

**LED 3-Phasen Schienenleuchte** direktstrahlend. Lichtkanal aus Aluminium-Strangpressprofil mit einer Breite von 50 mm. Fertigung der Leuchtenlänge millimetergenau auf Kundenwunsch möglich. Oberfläche der Leuchte feinstruktur matt pulverbeschichtet ähnlich RAL 9016 weiß, RAL 9006 silber oder RAL 9005 schwarz – auf Anfrage in RAL nach Wahl. Die Leuchte ist ausgestattet mit einem hochwertigen, facettierten BAP-Raster mit einer Auswahl an sieben verschiedenen Farben – Oberfläche hochglänzend bzw. matt. Der LED-Treiber ist im Leuchtgehäuse integriert – wahlweise als on/off oder DALI-Variante. Farbtemperaturen 2700K, 3000K oder 4000K – Farbwiedergabe CRI>80 oder CRI>90 – Mac Adam ≤3. Weitere Steuerungsoptionen oder Lichtfarben auf Anfrage erhältlich. Außerdem ist die Integration vieler Komponenten, wie beispielsweise Notlicht oder Sensortechnologie, sowie eine Vielzahl weiterer Optionen möglich.

**LED 3-phase track luminaire** with direct beam. Light channel made of extruded aluminium profile with a width of 50 mm. Luminaire length can be manufactured to the exact millimetre on customer request. Surface of the luminaire fine structure matt powder coated similar to RAL 9016 white, RAL 9006 silver or RAL 9005 black - on request in RAL of choice. The luminaire is equipped with a high-quality, faceted BAP louvre with a choice of seven different colours - specular or matt finish. The LED driver is integrated in the luminaire housing - either as on/off or DALI version. Colour temperatures 2700K, 3000K or 4000K - colour rendering CRI>80 or CRI>90 - Mac Adam ≤3. Further control options or light colours available on request. In addition, the integration of many components, such as emergency lighting or sensor technology, as well as a variety of other options is possible.

**Luminaire LED triphasé sur rail** à éclairage direct. Canal lumineux en profilé d'aluminium extrudé d'une largeur de 50 mm. Possibilité de fabriquer la longueur du luminaire au millimètre près sur demande du client. Surface du luminaire à structure fine, revêtement par poudre mat similaire à RAL 9016 blanc, RAL 9006 argent ou RAL 9005 noir - sur demande en RAL au choix. Le luminaire est équipé d'une grille BAP à facettes de haute qualité avec un choix de sept couleurs différentes - surface brillante ou mate. Le pilote LED est intégré dans le boîtier du luminaire - au choix sous forme de variante on/off ou DALI. Températures de couleur 2700K, 3000K ou 4000K - Rendu des couleurs CRI>80 ou CRI>90 - Mac Adam ≤3. Autres options de commande ou couleurs de lumière disponibles sur demande. En outre, l'intégration de nombreux composants, tels que l'éclairage de secours ou la technologie de détection, une multitude d'autres options sont possibles.

## ÜBERSICHT | OVERVIEW | VUE D'ENSEMBLE

TECHNICAL DATA
2700K / 3000K / 4000K
CRI>80 / CRI>90
MacAdam ≤ 3
up to 147 lm/W, up to 4.422 lm/m
on-off / DALI
direct
BAP-Louvre (UGR <19)
L80 B10 50.000h



HOUSING COLOUR	
schwarz   black   noir RAL 9005	
silber   silver   argent RAL 9006	
weiß   white   blanc RAL 9016	

BAP LOUVRE COLOUR			
silber hochglanz   silver specular   argenté brillant		gold hochglanz   gold specular   doré brillant	
silber matt   silver matt   argenté mat		bronze hochglanz   bronze specular   bronze brillant	
schwarz hochglanz   black specular   noir brillant		titan hochglanz   titan specular   titan brillant	
schwarz matt   black matt   noir mat			



**SCHIENENSTRAHLER „officeLINE50“**  
**TRACK SPOTLIGHT “officeLINE50”**  
**PROJECTEUR SUR RAIL « officeLINE50 »**

Bestellbeispiel | Example order | Exemple de commande  
 971 mm, CRI90, 4000K, **direct**, low output on/off, black, gold specular

**OL50T-099401-LOBLG**

1 2 3 4 5 6

**1** LÄNGE  
 LENGTH  
 LONGEUR

491 mm	<b>06</b>
971 mm	<b>09</b>
1.211 mm	<b>12</b>
1.451 mm	<b>14</b>

**2** FARBWIEDERGABE  
 COLOUR RENDERING  
 RENDU DES COULEURS

CRI>80	<b>8</b>
CRI>90	<b>9</b>

**3** FARBTEMPERATUR  
 COLOUR TEMPERATURE  
 TEMPÉRATURE DE COULEUR

2700K (CRI90 only)	<b>27</b>
3000K	<b>30</b>
4000K	<b>40</b>

**4** LEISTUNG & STEUERUNG  
 OUTPUT & CONTROL  
 SORTIE & CONTRÔLE

low output on/off	<b>LO</b>
low output DALI	<b>LD</b>
high output on/off	<b>HO</b>
high output DALI	<b>HD</b>

**5** GEHÄUSEFARBE  
 HOUSING COLOUR  
 COULEUR DU BOÎTIER

silver RAL 9006	<b>SI</b>
white RAL 9016	<b>WH</b>
black RAL 9005	<b>BL</b>

**6** BAP-RASTER FARBE  
 BAP LOUVRE COLOUR  
 GRILLE BAP COULEUR

silver specular	<b>S</b>
silver matt	<b>M</b>
black specular	<b>N</b>
black matt	<b>B</b>
gold specular	<b>G</b>
bronze matt	<b>C</b>
titan specular	<b>T</b>

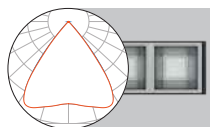
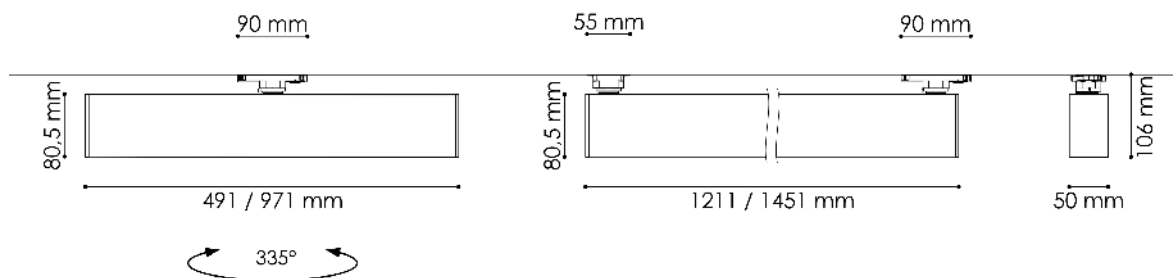

direct direct

Size [mm]	low output [lm] / [W]	high output [lm] / [W]	KE
491	1.106 / 8,6	2.064 / 16,5	1,4
971	2.212 / 16,7	4.128 / 31,9	2,3
1.211	2.765 / 20,0	5.160 / 39,0	2,8
1.451	3.318 / 23,5	6.192 / 46,0	3,3

Alle Lumenangaben für 4000K, CRI>80, Reflektor silber hochglanz  
 All lumen values for 4000K, CRI>80, reflector silver specular  
 Toutes les données de lumens pour 4000K, CRI>80, réflecteur argenté brillant

# OVERVIEW

SCHIENEN | TRACKS | RAILS

## ANBAU | SURFACE MOUNTED | *EN SAILLIE*



SLIM TRACK  
**252**



BASIC TRACK  
**256**



ACCESSORIES  
**272**

## PENDEL | SUSPENDED | *SUSPENSION*



SLIM TRACK  
**252**



BASIC TRACK  
**256**



H-TRACK  
**260**



ACCESSORIES  
**272**

## EINBAU | RECESSED | *ENCASTRÉ*



FRAME TRACK  
**264**



FRAMELESS TRACK  
**268**



ACCESSORIES  
**272**

# SCHIENEN & ZUBEHÖR

TRACKS & ACCESSORIES

RAILS & ACCESSOIRES

# SCHIENEN

TRACKS  
RAILS

1. H-TRACK PENDEL | SUSPENDED | *SUSPENSION*
2. BASIC TRACK PENDEL | SUSPENDED | *SUSPENSION*
3. SLIM TRACK PENDEL | SUSPENDED | *SUSPENSION*
4. SLIM TRACK ANBAU | SURFACE MOUNTED | *EN SAILLIE*
5. BASIC TRACK ANBAU | SURFACE MOUNTED | *EN SAILLIE*
6. FRAME TRACK EINBAU | RECESSED | *ENCASTRÉ*
7. FRAMELESS TRACK EINBAU | RECESSED | *ENCASTRÉ*





4

5

6

7

# LINE48V

SLIM TRACK | SLIM TRACK | SLIM TRACK

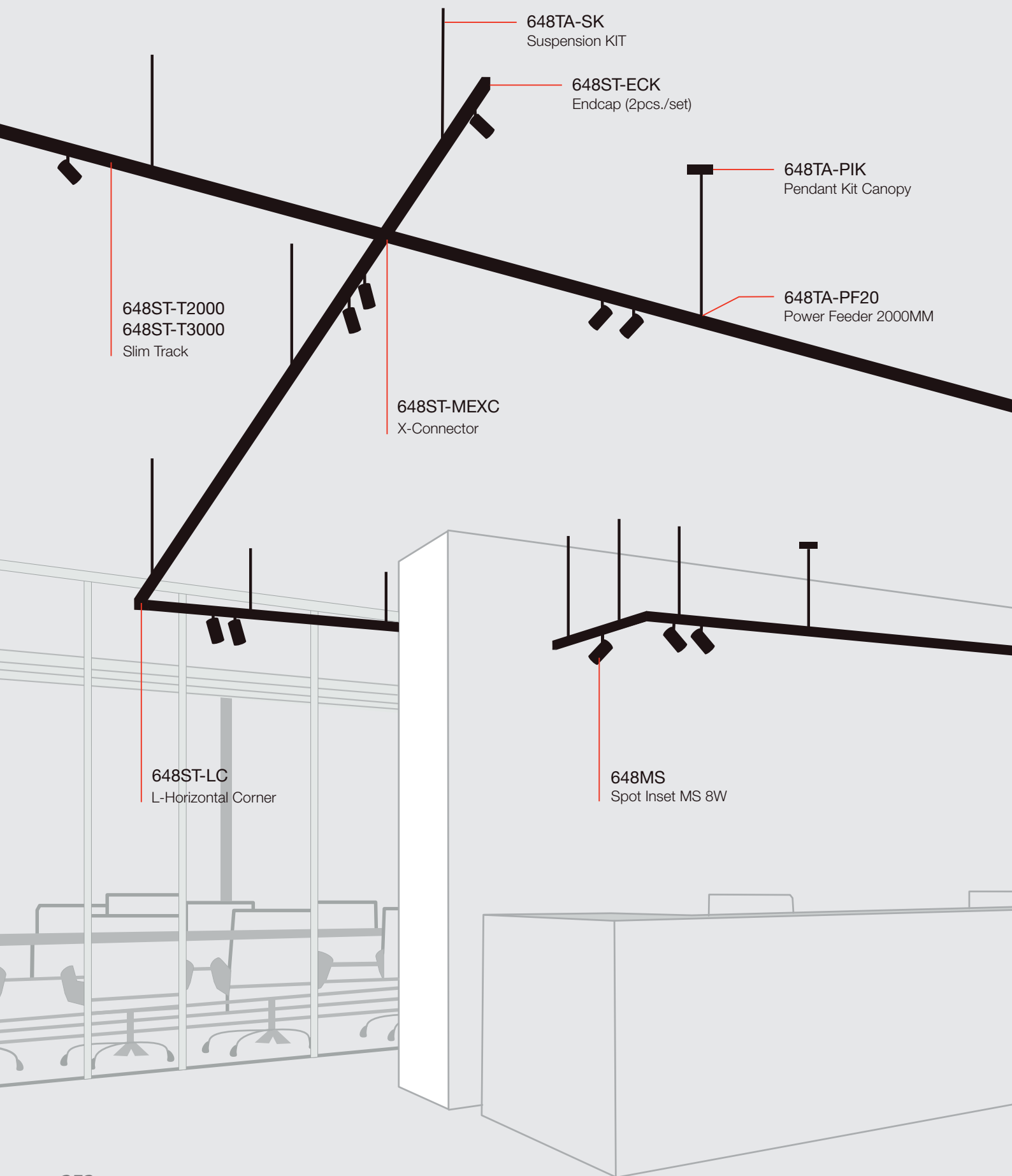

648TA-SK  
Suspension KIT

648ST-ECK  
Endcap (2pcs./set)

648TA-PIK  
Pendant Kit Canopy

648TA-PF20  
Power Feeder 2000MM

648ST-T2000  
648ST-T3000  
Slim Track

648ST-MEXC  
X-Connector

648ST-LC  
L-Horizontal Corner

648MS  
Spot Inset MS 8W

648TA-SECK  
Straight Electrical Connector

The diagram illustrates a lighting system with two main tracks. The upper track is a thick black line sloping downwards from left to right. It features several vertical black lines representing electrical connectors. Two spotlights are mounted on this track. The lower track is a thick black line sloping upwards from left to right. It also has several vertical black lines representing electrical connectors and two spotlights. A vertical red line on the right side of the lower track indicates a T-connector. On the left, a grey rectangular area represents a wall or ceiling panel, with two spotlights mounted on a track. A vertical red line on the left side of this panel indicates a spot inset.

648MD  
Spot Inset MD 16W

648ST-METC  
T-Connector



# LINE48V

SLIM TRACK | SLIM TRACK | SLIM TRACK

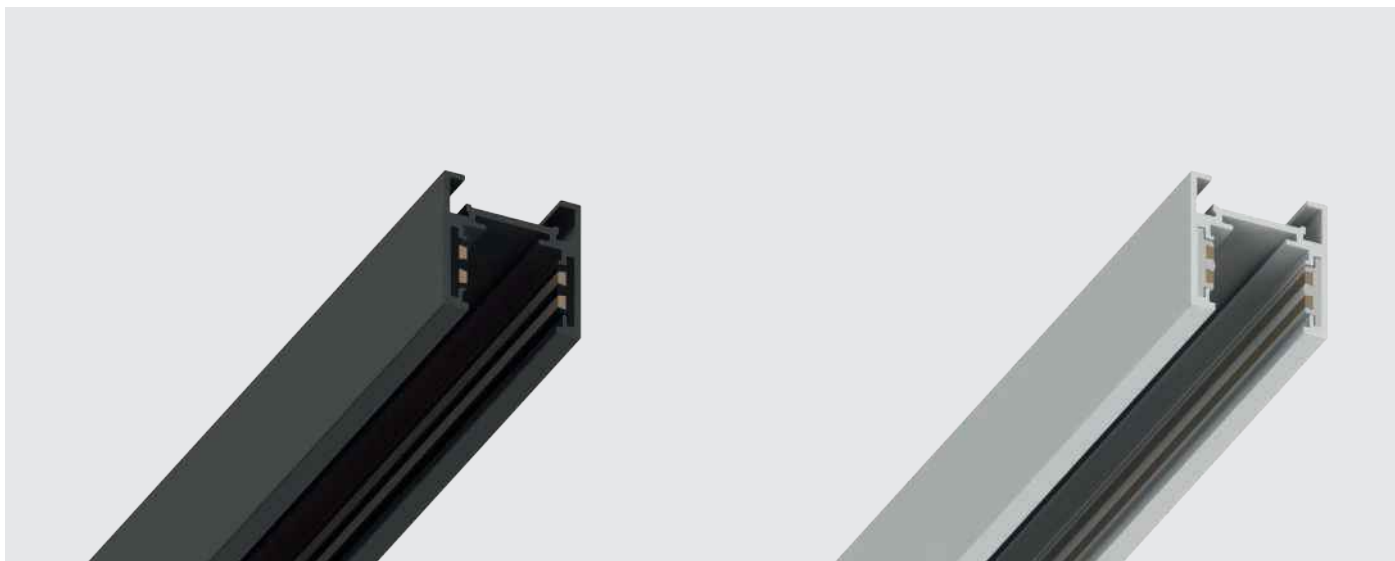

LINE48V ist die modulare 48V-Niedervolt-Systemlösung mit einem schlanken Designansatz, der auf ein 26 mm breites Aluminium-Strangpressprofil reduziert ist. Dank der minimalen Höhe von 27 mm bietet die SLIM TRACK ein minimalistisches, elegantes Design, das sich perfekt in die gegebene Architektur einfügt. Alle LINE48V-Schienen sind in den Farben schwarz (RAL 9005) und weiß (RAL 9016) pulverbeschichtet erhältlich. Die Leuchteinsätze werden durch einen einfachen Einrastmechanismus mit dem Profil verbunden, der ein hohes Maß an Flexibilität ohne den Einsatz von Werkzeug bietet. Um das LINE48V-System optimal zu erweitern, bieten verschiedene Verbinder in I-, L-, T- oder X-Form eine Vielzahl von Gestaltungsmöglichkeiten.

LINE48V is the modular 48V Low Voltage System solution with a sleek design approach, which is reduced to a 26 mm wide extruded aluminium profile. Thanks to the minimal height of 27 mm, the SLIM TRACK offers a sleek, elegant design, that fits perfectly into the given architecture. All LINE48V tracks are available in a powder-coated black (RAL 9005) and white (RAL 9016) finish. The light inserts will be connected to the profile by a simple click-in mechanism, which offers a high degree of flexibility without using any tools. To extend the LINE48V system to its maximum, different connectors in I, L, T or X-shape are providing a numerous design options.

LINE48V est la solution modulaire de système basse tension 48V au design épuré, qui se réduit à un profilé d'aluminium extrudé de 26 mm de large. Grâce à sa hauteur réduite de 27 mm, le SLIM TRACK offre un design minimaliste et élégant qui s'intègre parfaitement à l'architecture. Tous les rails LINE48V sont disponibles en noir (RAL 9005) et blanc (RAL 9016) avec revêtement par poudre. Les inserts lumineux seront connectés au profilé par un simple mécanisme d'encastrement, qui offre un haut degré de flexibilité sans l'utilisation d'outils. Pour étendre le système LINE48V au maximum, différents connecteurs en forme de I, L, T ou X offrent de nombreuses options de conception.

## ÜBERSICHT | OVERVIEW | VUE D'ENSEMBLE



SURFACE MOUNTED

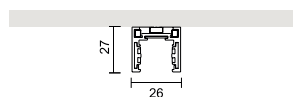

SUSPENDED

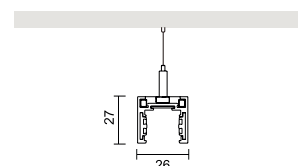

colour	housing material	dimensions [mm]	weight [kg]	material number
■ black [RAL 9005]	aluminium	L 2000 / W 26 / H 27	1,44	<b>648ST-T2000-B</b>
□ white [RAL 9016]	aluminium	L 2000 / W 26 / H 27	1,44	<b>648ST-T2000-W</b>
■ black [RAL 9005]	aluminium	L 3000 / W 26 / H 27	2,16	<b>648ST-T3000-B</b>
□ white [RAL 9016]	aluminium	L 3000 / W 26 / H 27	2,16	<b>648ST-T3000-W</b>

### ACCESSORIES BLACK

648ST-ECK-B



648ST-LC-B



648ST-LVC-B



648ST-METC-B



648ST-MEXC-B



### ACCESSORIES WHITE

648ST-ECK-W



648ST-LC-W



648ST-LVC-W



648ST-METC-W



648ST-MEXC-W



- All article numbers of the accessories can be found on p. 272 and 273.
- Corners incl. flexible continuous electrical kit.

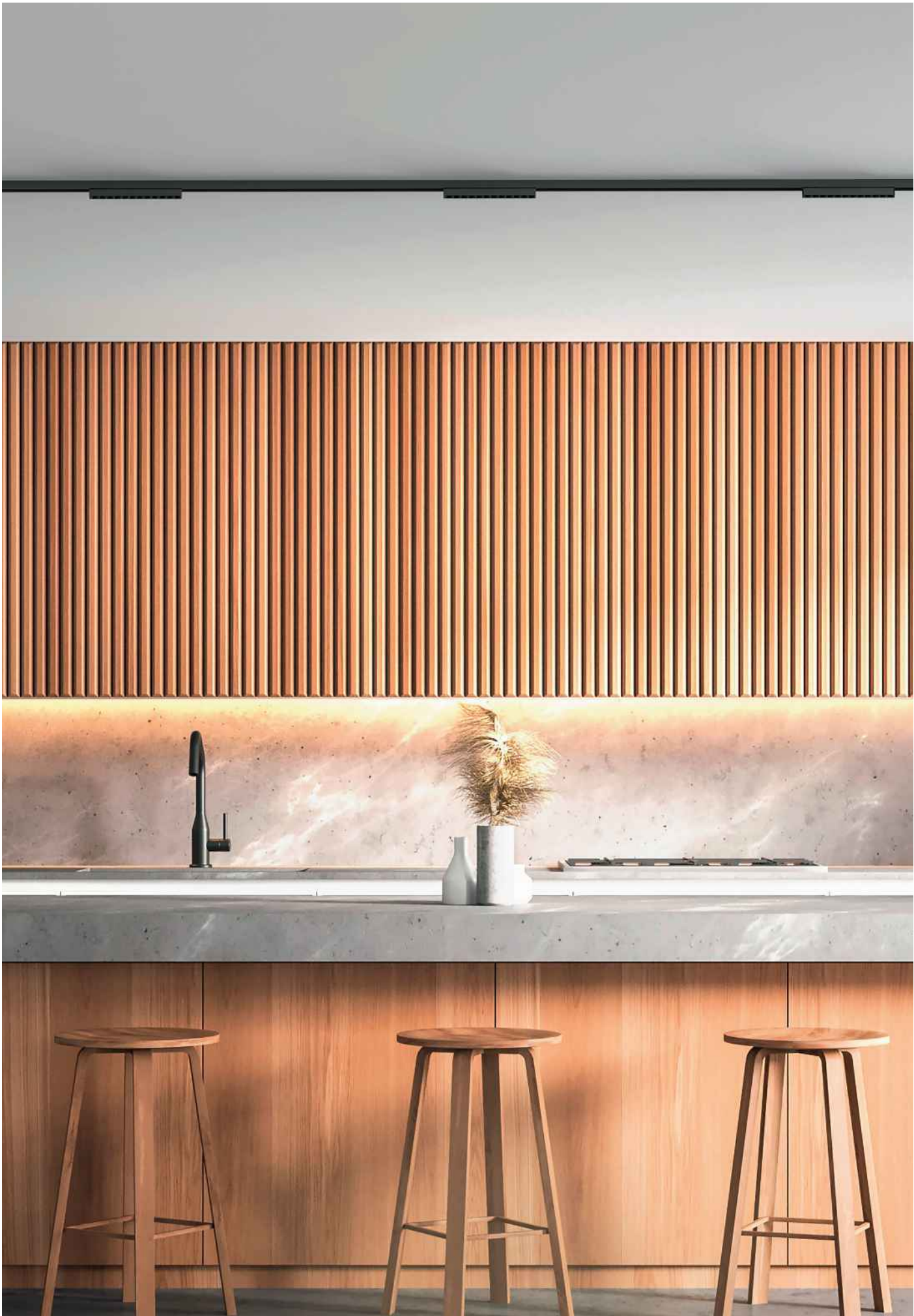

# LINE48V

BASIC TRACK | BASIC TRACK | BASIC TRACK

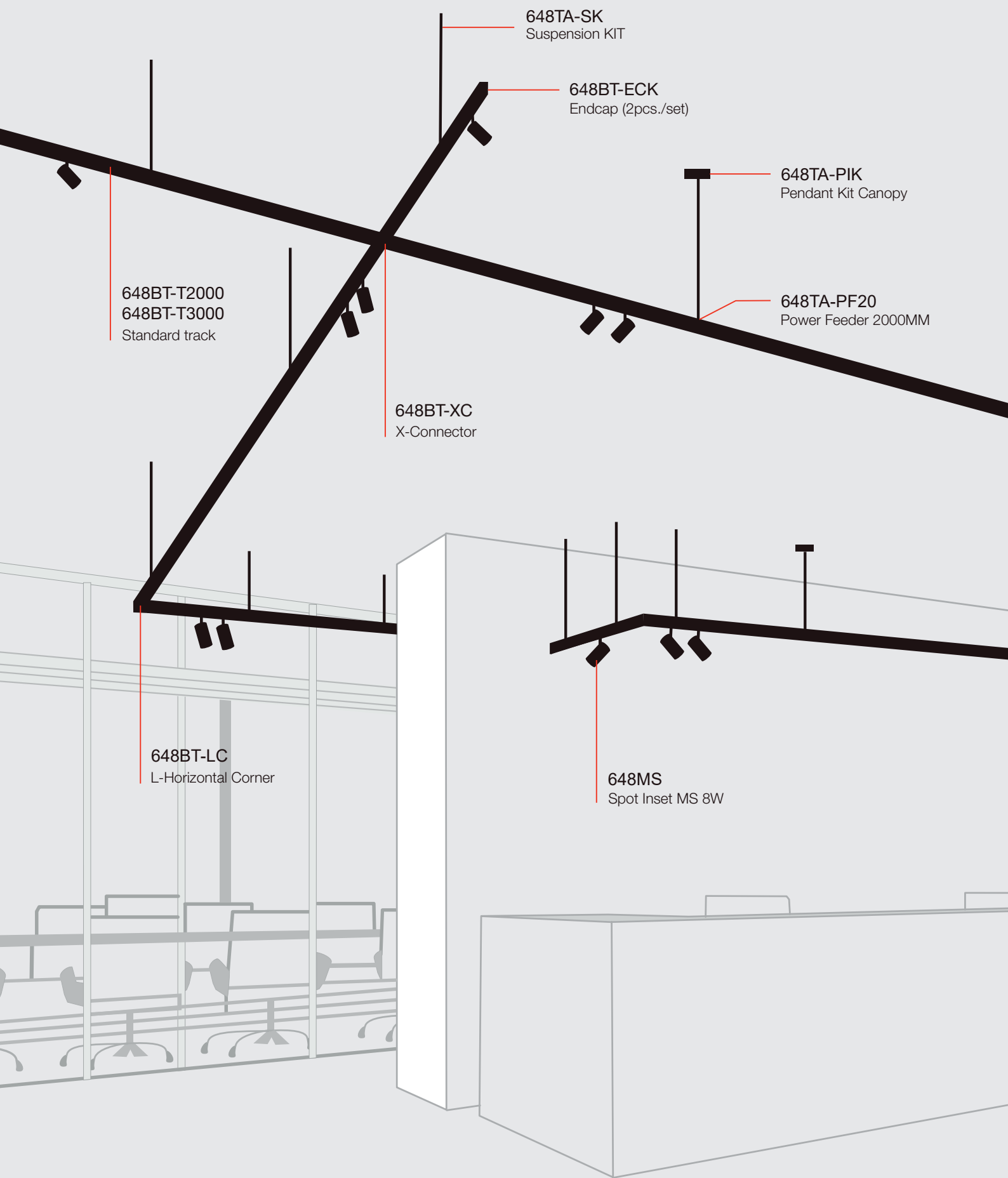

648TA-SK  
Suspension KIT

648BT-ECK  
Endcap (2pcs./set)

648TA-PIK  
Pendant Kit Canopy

648TA-PF20  
Power Feeder 2000MM

648BT-T2000  
648BT-T3000  
Standard track

648BT-XC  
X-Connector

648BT-LC  
L-Horizontal Corner

648MS  
Spot Inset MS 8W

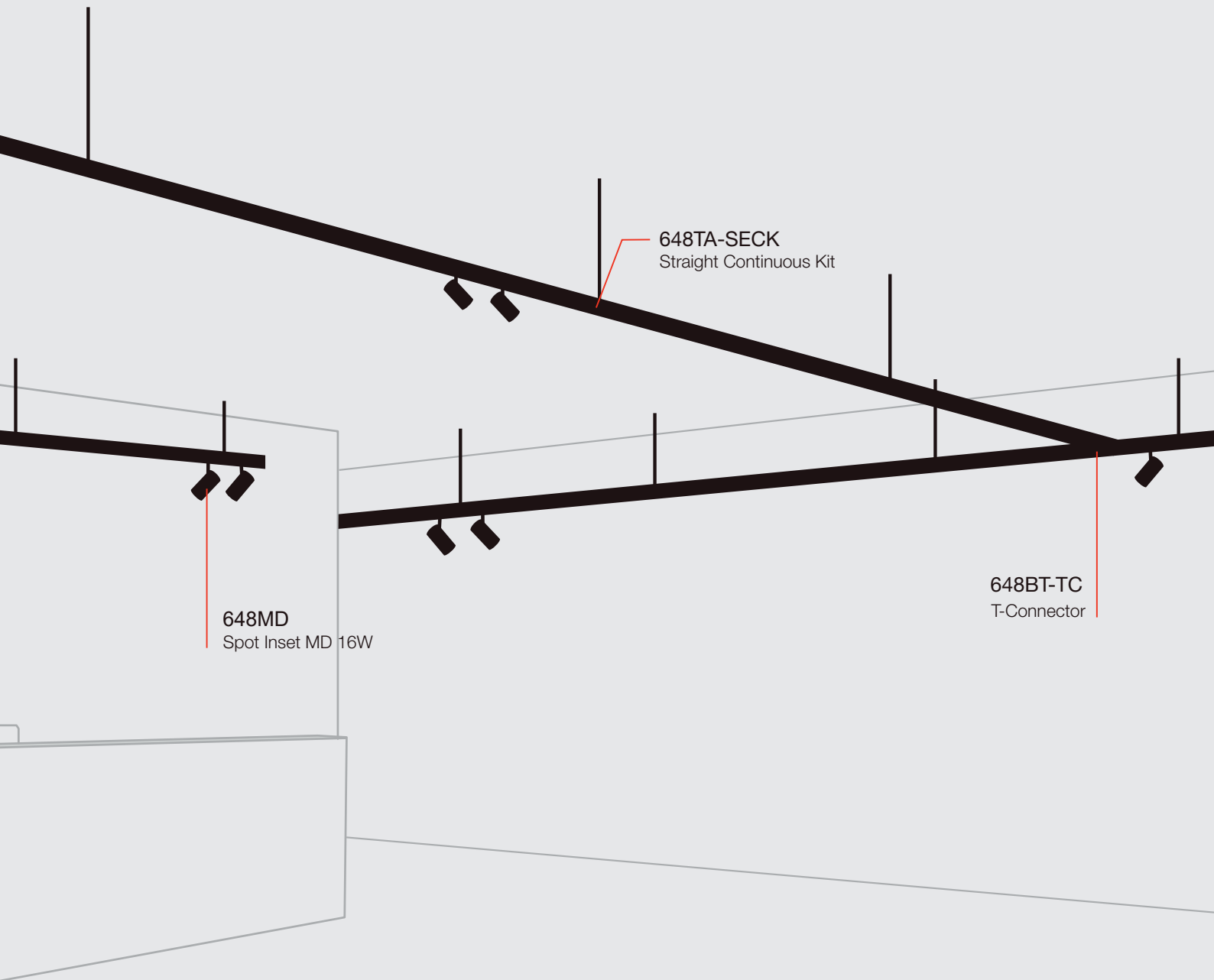

648TA-SECK  
Straight Continuous Kit

648MD  
Spot Inset MD 16W

648BT-TC  
T-Connector

# LINE48V

BASIC TRACK | BASIC TRACK | BASIC TRACK



LINE48V ist die modulare 48V-Niedervolt-Systemlösung mit einem schlanken Designansatz, der auf ein 26 mm breites Aluminium-Strangpressprofil reduziert ist. Die BASIC TRACK mit einer Höhe von 52 mm ermöglicht ideale Lösungen für die Hänge und Anbaumontage. Alle LINE48V-Stromschienen sind in den Farben schwarz (RAL 9005) und weiß (RAL 9016) pulverbeschichtet erhältlich. Die Lichteinsätze werden durch einen einfachen Einrastmechanismus mit dem Profil verbunden, der ein hohes Maß an Flexibilität ohne den Einsatz von Werkzeug bietet. Um das LINE48V-System optimal zu erweitern, bieten verschiedene Verbinder in I-, L-, T- oder X-Form eine Vielzahl von Gestaltungsmöglichkeiten.

LINE48V is the modular 48V Low Voltage System solution with a sleek design approach, which is reduced to a 26 mm wide extruded aluminium profile. The BASIC TRACK with the height of 52 mm allows ideal solutions for pendant and surface mounted installation. All LINE48V tracks are available in a powder-coated black (RAL 9005) and white (RAL 9016) finish. The light inserts will be connected to the profile by a simple click-in mechanism, which offers a high degree of flexibility without using any tools. To extend the LINE48V system to its maximum, different connectors in I, L, T or X-shape are providing a numerous design options.

LINE48V est la solution modulaire de système basse tension de 48V avec une approche de conception élégante, réduite à un profilé d'aluminium extrudé de 26 mm de large. Le rail BASIC, d'une hauteur de 52 mm, offre des solutions idéales pour les installations suspendues ou en saillie. Tous les rails LINE48V sont disponibles en noir (RAL 9005) et blanc (RAL 9016) avec revêtement par poudre. Les modules d'éclairage seront connectés au profilé par un simple mécanisme d'encliquetage, ce qui offre un haut degré de flexibilité sans utiliser d'outils. Pour étendre au maximum le système LINE48V, différents connecteurs en I, L, T ou X offrent de nombreuses possibilités de conception.

## ÜBERSICHT | OVERVIEW | VUE D'ENSEMBLE



SURFACE MOUNTED

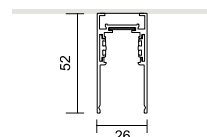

SUSPENDED

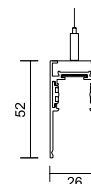

colour	housing material	dimensions [mm]	weight [kg]	material number
■ black [RAL 9005]	aluminium	L 2000 / W 26 / H 52	2,10	<b>648BT-T2000-B</b>
□ white [RAL 9016]	aluminium	L 2000 / W 26 / H 52	2,10	<b>648BT-T2000-W</b>
■ black [RAL 9005]	aluminium	L 3000 / W 26 / H 52	3,15	<b>648BT-T3000-B</b>
□ white [RAL 9016]	aluminium	L 3000 / W 26 / H 52	3,15	<b>648BT-T3000-W</b>

### ACCESSORIES BLACK

648BT-ECK-B



648BT-LC-B



648BT-LVC-B



648BT-TC-B



648BT-XC-B



648TA-SK-B



### ACCESSORIES WHITE

648BT-ECK-W



648BT-LC-W



648BT-LVC-W



648BT-TC-W



648BT-XC-W



- All article numbers of the accessories can be found on p. 272 and 273.
- Corners incl. flexible continuous electrical kit.



# LINE48V

H-TRACK | H-TRACK | H-TRACK

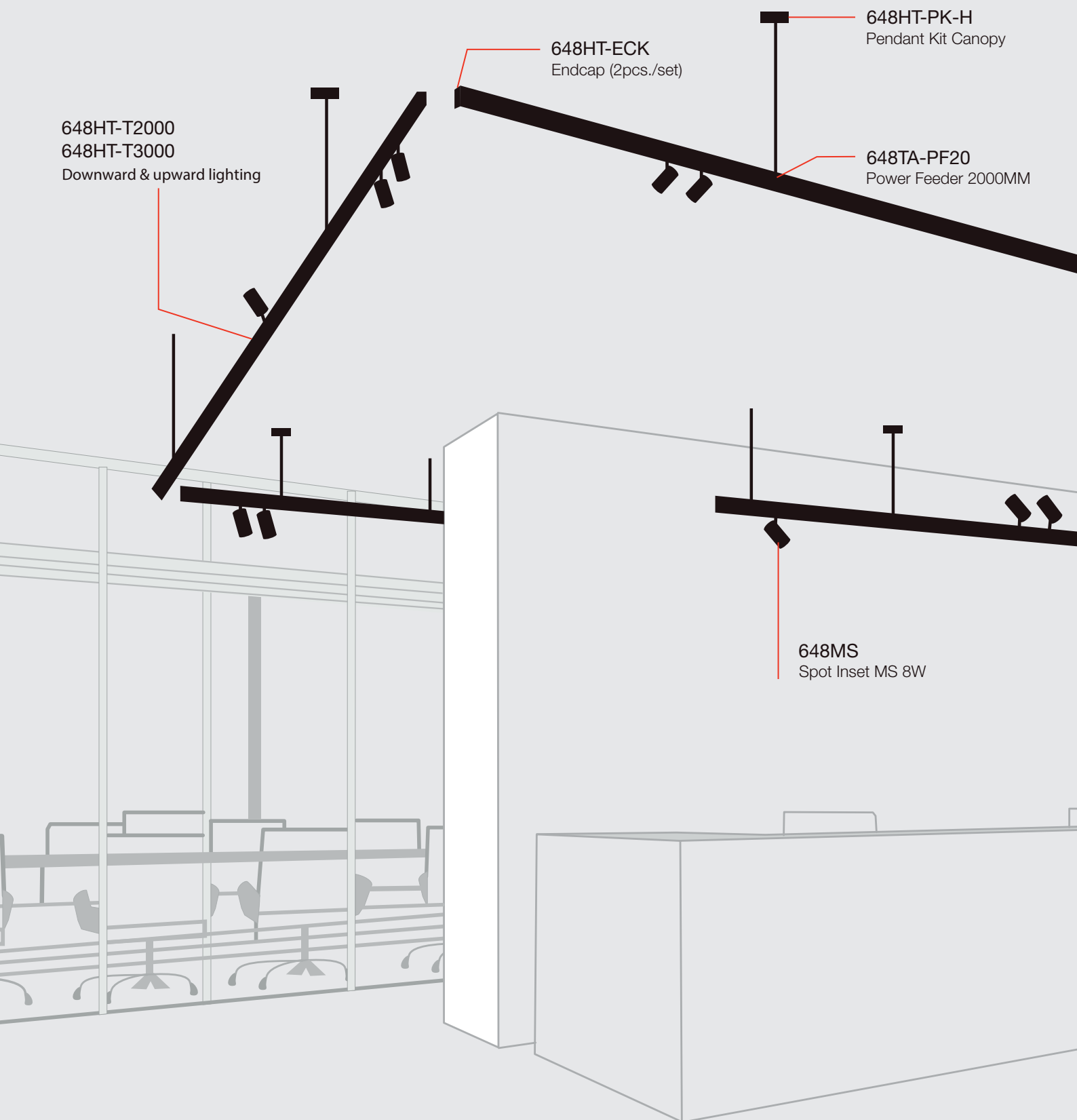



648HT-LCPK  
Linear Connector Inkl Pendant Kit

648HT-LMC  
Linear Mechanical Connector

648HT-SK  
Suspension Kit

648HT-FECK  
Flex Electrical Connector

648MD  
Spot Inset MD 16W

# LINE48V

H-TRACK | H-TRACK | H-TRACK



LINE48V ist die modulare 48V-Niedervolt-Systemlösung mit einem schlanken Designansatz, der auf ein 26 mm breites Aluminium-Strangpressprofil reduziert ist. Die doppelseitige H-TRACK mit einer Höhe von 90 mm bietet eine revolutionäre Pendellösung, bei der alle Einsätze von unten und oben installiert werden können. Alle LINE48V-Schienen sind in den Farben schwarz (RAL 9005) und weiß (RAL 9016) pulverbeschichtet erhältlich. Die Leuchteinsätze werden durch einen einfachen Einrastmechanismus mit dem Profil verbunden, der ein hohes Maß an Flexibilität ohne den Einsatz von Werkzeug bietet. Um das LINE48V-System optimal zu erweitern, bieten die geraden Verbinder eine Vielzahl von Gestaltungsmöglichkeiten für die H-Schiene.

LINE48V is the modular 48V Low Voltage System solution with a sleek design approach, which is reduced to a 26 mm wide extruded aluminium profile. The double-sided H-TRACK with the height of 90 mm provides a revolutionised pendant solution, where all the inserts can be installed from below and above. All LINE48V tracks are available in a powder-coated black (RAL 9005) and white (RAL 9016) finish. The light inserts will be connected to the profile by a simple click-in mechanism, which offers a high degree of flexibility without using any tools. To extend the LINE48V system to its maximum, straight line connectors are providing a numerous design options for the H-Track.

LINE48V est la solution modulaire de système basse tension 48V au design épuré, réduite à un profilé d'aluminium extrudé de 26 mm de large. Le rail H double face d'une hauteur de 90 mm offre une solution suspendue révolutionnaire, où tous les inserts peuvent être installés par le bas et par le haut. Tous les rails LINE48V sont disponibles en noir (RAL 9005) et blanc (RAL 9016) avec revêtement par poudre. Les modules d'éclairage sont reliés au profilé par un simple mécanisme d'encliquetage, qui offre un haut degré de flexibilité sans aucun outil. Pour étendre au maximum le système LINE48V, les connecteurs de ligne droite offrent de nombreuses options de conception pour le rail en H.

## ÜBERSICHT | OVERVIEW | VUE D'ENSEMBLE

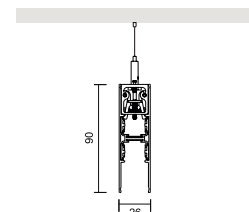

colour	housing material	dimensions [mm]	weight [kg]	material number
■ black [RAL 9005]	aluminium	L 2000 / W 26 / H 90	2,80	<b>648HT-T2000-B</b>
□ white [RAL 9016]	aluminium	L 2000 / W 26 / H 90	2,80	<b>648HT-T2000-W</b>
■ black [RAL 9005]	aluminium	L 3000 / W 26 / H 90	4,20	<b>648HT-T3000-B</b>
□ white [RAL 9016]	aluminium	L 3000 / W 26 / H 90	4,20	<b>648HT-T3000-W</b>

ACCESSORIES BLACK	
648HT-ECK-B	
648HT-LMC-B	
648HT-LCPK	
648HT-SK	
648HT-PK-H-B	

ACCESSORIES WHITE	
648BT-ECK-W	
648BT-LC-W	

- All article numbers of the accessories can be found on p. 272 and 273.
- Corners incl. flexible continuous electrical kit.



# LINE48V

FRAME TRACK | FRAME TRACK | FRAME TRACK

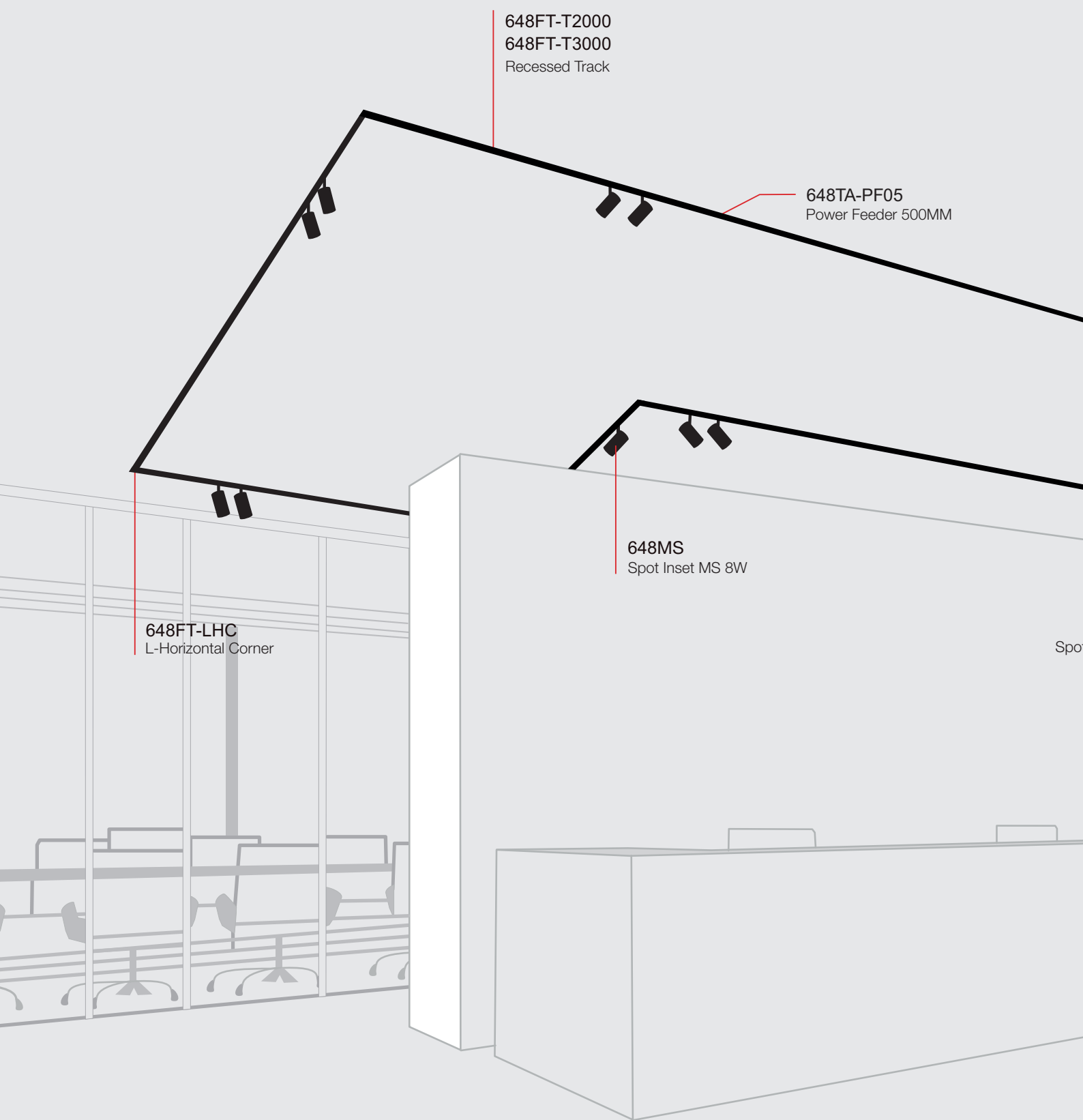

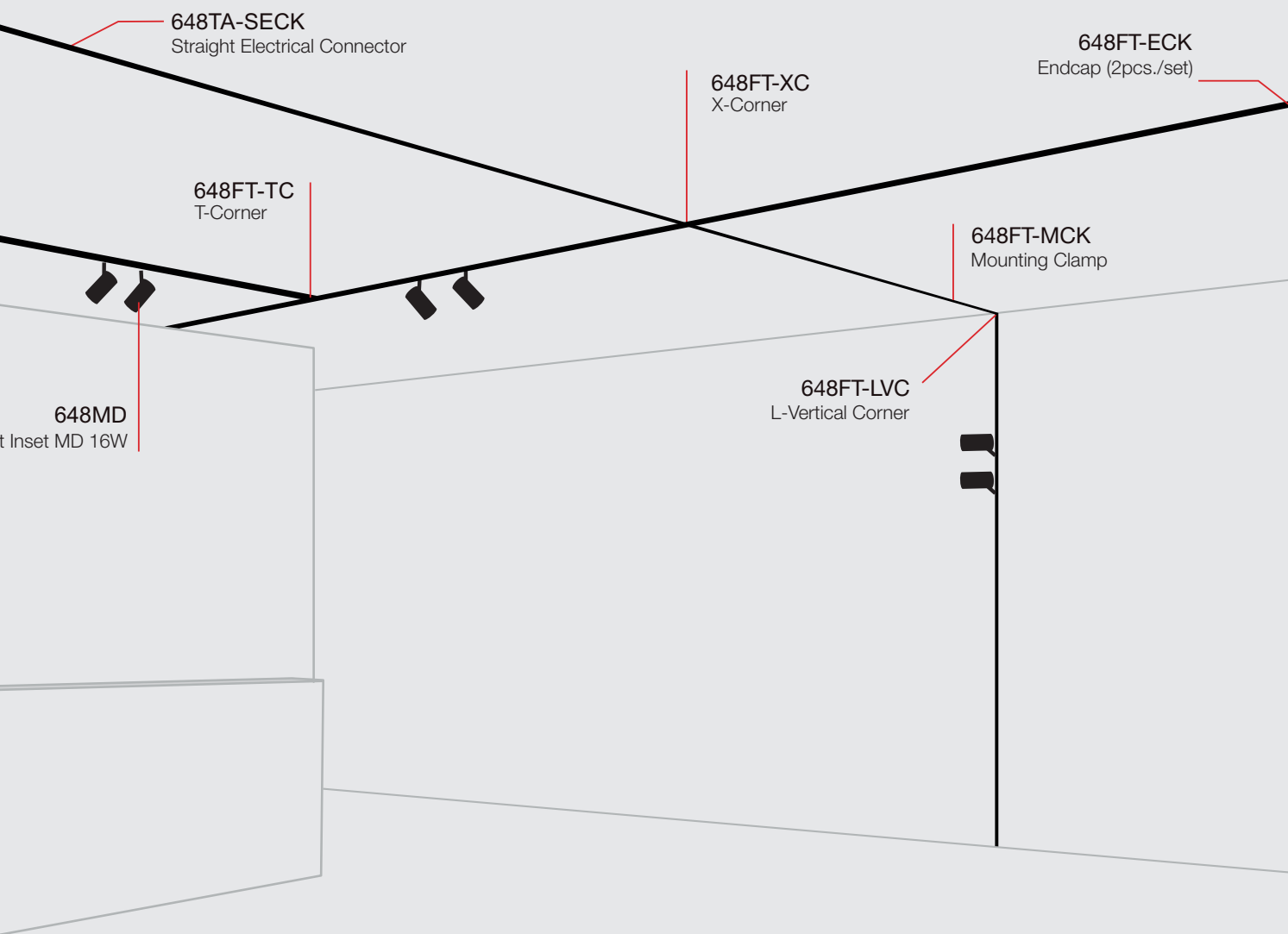

# LINE48V

FRAME TRACK | FRAME TRACK | FRAME TRACK



LINE48V ist die modulare 48V-Niedervolt-Systemlösung mit einem schlanken Designansatz, der auf ein 26 mm breites inneres Aluminium-Strangpressprofil reduziert ist. Die FRAME TRACK mit einer äußeren Profilbreite von 36 mm ermöglicht ideale Lösungen für den Deckeneinbau. Alle LINE48V Schienen sind in den Farben schwarz (RAL 9005) und weiß (RAL 9016) pulverbeschichtet erhältlich. Die Lichteinsätze werden durch einen einfachen Einrastmechanismus mit dem Profil verbunden, der ein hohes Maß an Flexibilität ohne den Einsatz von Werkzeug bietet. Um das LINE48V-System optimal zu erweitern, bieten verschiedene Verbinder in I-, L-, T- oder X-Form eine Vielzahl von Gestaltungsmöglichkeiten.

LINE48V is the modular 48V Low Voltage System solution with a sleek design approach, which is reduced to a 26 mm inner profile wide extruded aluminium profile. The FRAME TRACK with the outer profile width of 36 mm allows ideal solutions for recessed installation. All LINE48V tracks are available in a powder-coated black (RAL 9005) and white (RAL 9016) finish. The light inserts will be connected to the profile by a simple click-in mechanism, which offers a high degree of flexibility without using any tools. To extend the LINE48V system to its maximum, different connectors in I, L, T or X-shape are providing a numerous design options.

LINE48V est la solution modulaire de système basse tension 48V avec une approche de conception élégante, qui est réduite à un profil intérieur de 26 mm de large en aluminium extrudé. Le rail FRAME, avec un profil extérieur de 36 mm de large, offre des solutions idéales pour les installations encastrées. Tous les rails LINE48V sont disponibles en noir (RAL 9005) et blanc (RAL 9016) avec revêtement par poudre. Les modules d'éclairage seront connectés au profilé par un simple mécanisme d'encliquetage, ce qui offre un haut degré de flexibilité sans utiliser d'outils. Pour étendre au maximum le système LINE48V, différents connecteurs en I, L, T ou X offrent de nombreuses possibilités de conception.

## ÜBERSICHT | OVERVIEW | VUE D'ENSEMBLE

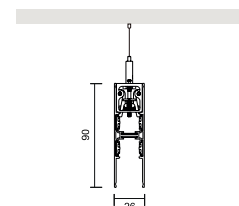

colour	housing material	dimensions [mm]	weight [kg]	material number
■ black [RAL 9005]	aluminium	L 2000 / W 38 / H 52	2,40	<b>648FT-T2000-B</b>
□ white [RAL 9016]	aluminium	L 2000 / W 38 / H 52	2,40	<b>648FT-T2000-W</b>
■ black [RAL 9005]	aluminium	L 3000 / W 38 / H 52	3,60	<b>648FT-T3000-B</b>
□ white [RAL 9016]	aluminium	L 3000 / W 38 / H 52	3,60	<b>648FT-T3000-W</b>

### ACCESSORIES BLACK

648FT-ECK-B	
648FT-LHC-B	
648FT-LVC-B	
648FT-TC-B	
648FT-XC-B	
648FT-MCK	

### ACCESSORIES WHITE

648FT-ECK-W	
648FT-LHC-W	
648FT-LVC-W	
648FT-TC-W	
648FT-XC-W	

- All article numbers of the accessories can be found on p. 272 and 273.
- Corners incl. flexible continuous electrical kit.

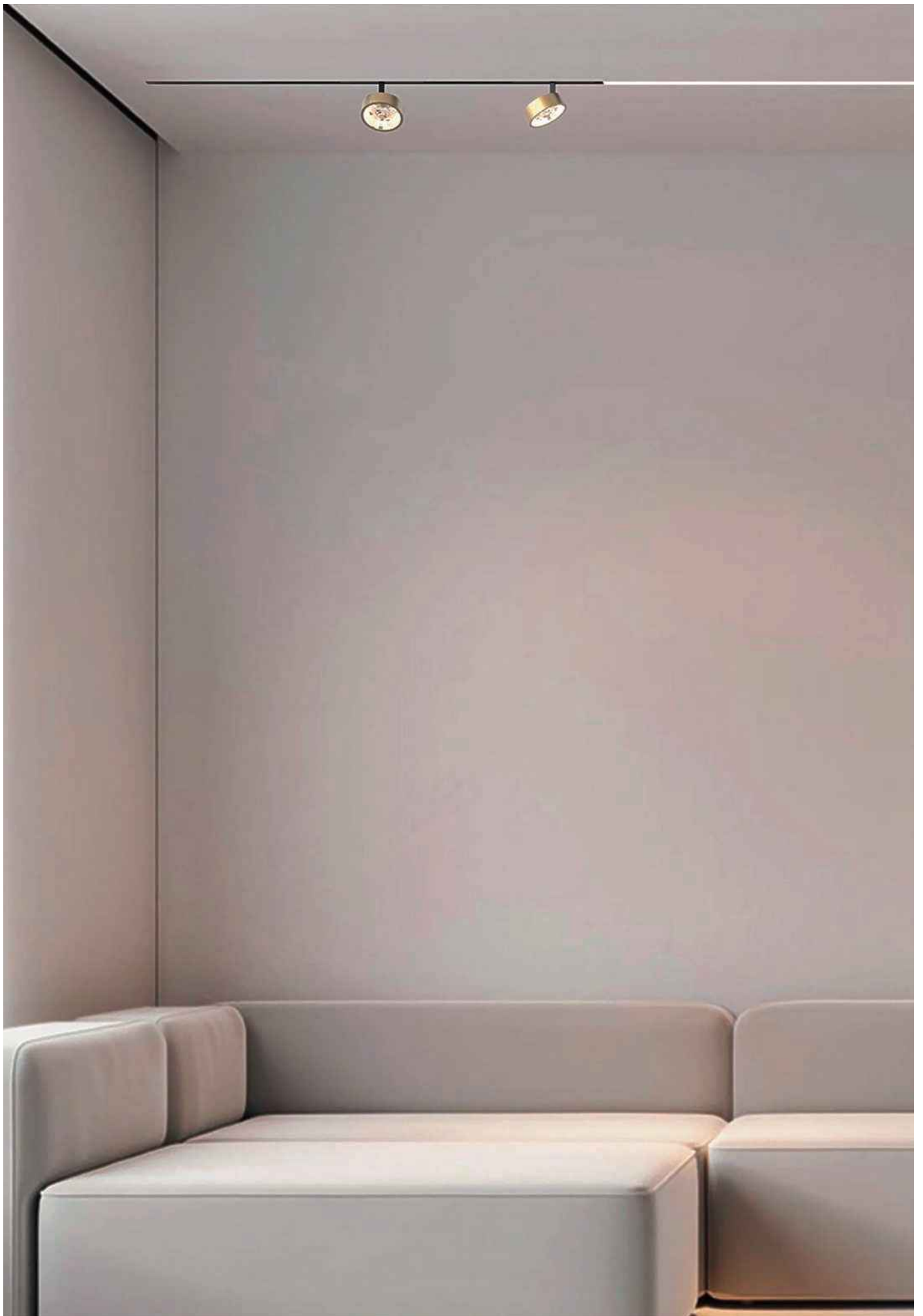



# LINE48V

FRAMELESS TRACK | FRAMELESS TRACK | *FRAMELESS TRACK*

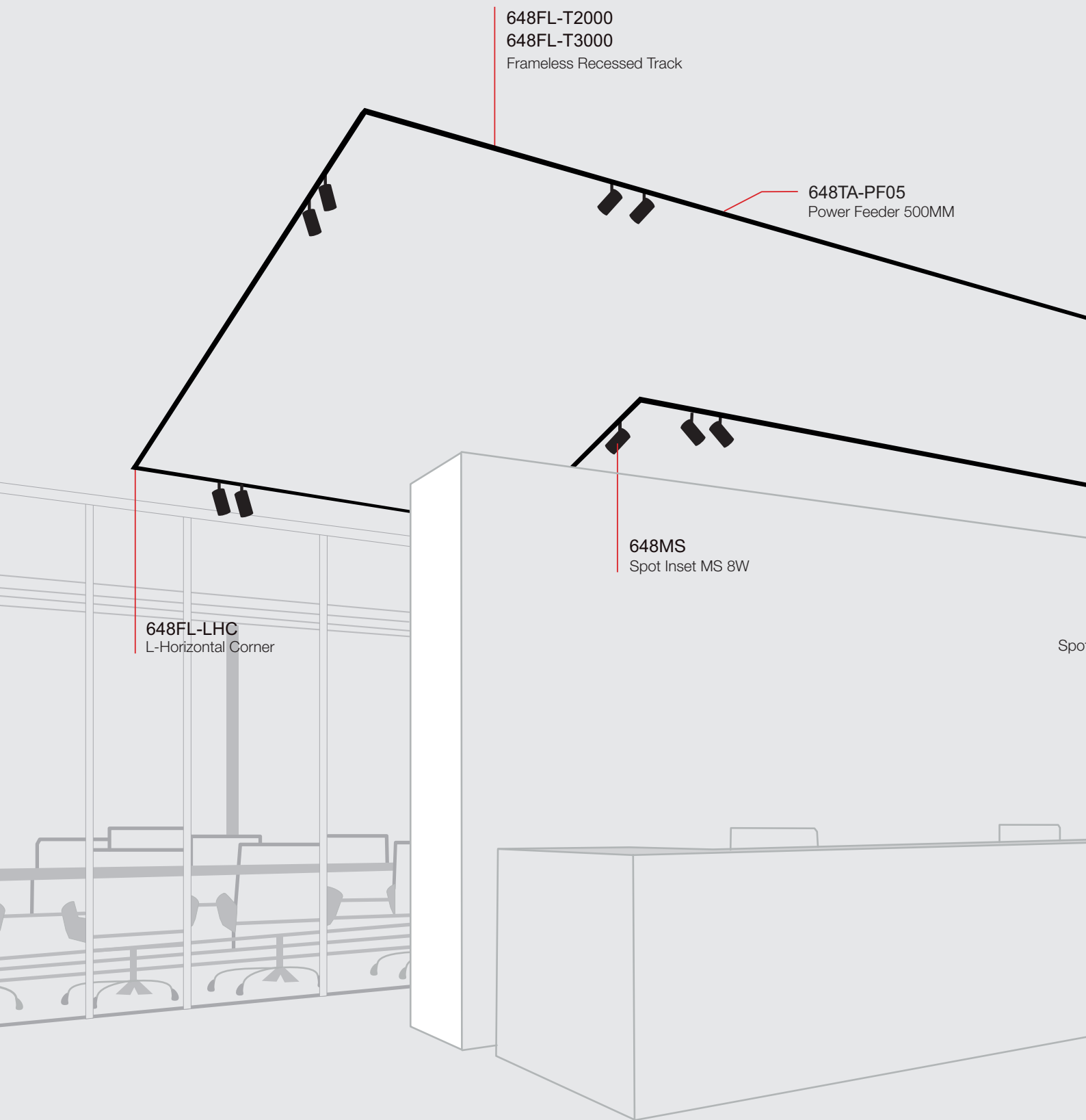

648FL-T2000  
648FL-T3000  
Frameless Recessed Track

648TA-PF05  
Power Feeder 500MM

648MS  
Spot Inset MS 8W

648FL-LHC  
L-Horizontal Corner

Spot

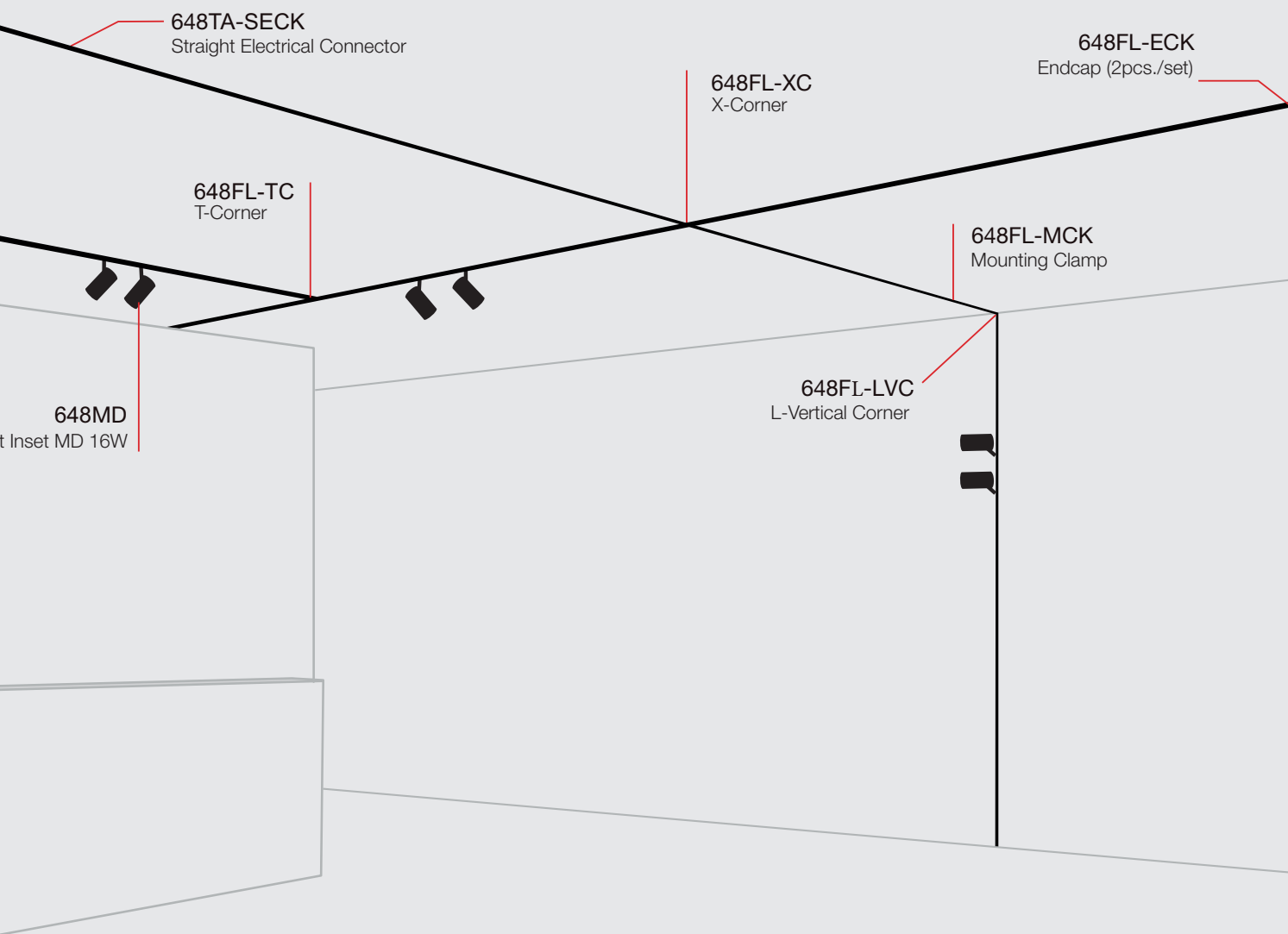

# LINE48V

FRAMELESS TRACK | FRAMELESS TRACK | FRAMELESS TRACK



LINE48V ist die modulare 48V-Niedervolt-Systemlösung mit einem schlanken Designansatz, der auf ein 26 mm breites Aluminium-Strangpressprofil reduziert ist. Die FRAMELESS TRACK ermöglicht ideale Lösungen für den rahmenlosen Einbau mit einem nahtlosen Übergang zwischen dem Profil und der Decke. Alle LINE48V-Schienen sind in den Farben schwarz (RAL 9005) und weiß (RAL 9016) pulverbeschichtet erhältlich. Die Leuchteinsätze werden durch einen einfachen Einrastmechanismus mit dem Profil verbunden, der ein hohes Maß an Flexibilität ohne den Einsatz von Werkzeug bietet. Um das LINE48V-System optimal zu erweitern, bieten verschiedene Verbinder in I-, L-, T- oder X-Form eine Vielzahl von Gestaltungsmöglichkeiten.

LINE48V is the modular 48V Low Voltage System solution with a sleek design approach, which is reduced to a 26 mm inner profile wide extruded aluminium profile. The FRAMELESS TRACK allows ideal solutions for trimless recessed installation with a seamless transition between the profile and the ceiling. All LINE48V tracks are available in a powder-coated black (RAL 9005) and white (RAL 9016) finish. The light inserts will be connected to the profile by a simple click-in mechanism, which offers a high degree of flexibility without using any tools. To extend the LINE48V system to its maximum, different connectors in I, L, T or X-shape are providing a numerous design options.

LINE48V est la solution modulaire de système basse tension de 48V avec une approche de conception élégante, qui est réduite à un profil intérieur de 26 mm de large en aluminium extrudé. Le rail FRAMELESS TRACK offre des solutions idéales pour les installations encastrées sans garniture, avec une transition transparente entre le profil et le plafond. Tous les rails LINE48V sont disponibles en noir (RAL 9005) et blanc (RAL 9016) avec revêtement par poudre. Les modules d'éclairage sont reliés au profilé par un simple mécanisme d'encliquetage, ce qui offre un haut degré de flexibilité sans aucun outil. Pour étendre au maximum le système LINE48V, différents connecteurs en forme de I, L, T ou X offrent de nombreuses possibilités de conception.

## ÜBERSICHT | OVERVIEW | VUE D'ENSEMBLE

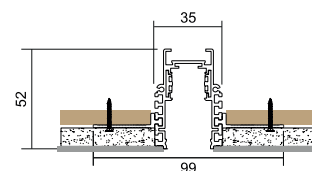

colour	housing material	dimensions [mm]	weight [kg]	material number
■ black [RAL 9005]	aluminium	L 2000 / W 35 / H 52	2,60	<b>648FL-T2000-B</b>
□ white [RAL 9016]	aluminium	L 2000 / W 35 / H 52	2,60	<b>648FL-T2000-W</b>
■ black [RAL 9005]	aluminium	L 3000 / W 35 / H 52	3,80	<b>648FL-T3000-B</b>
□ white [RAL 9016]	aluminium	L 3000 / W 35 / H 52	3,80	<b>648FL-T3000-W</b>

### ACCESSORIES BLACK

648FT-ECK-B	
648FT-LHC-B	
648FT-LVC-B	
648FT-TC-B	
648FT-XC-B	
648FT-MCK	

### ACCESSORIES WHITE

648FT-ECK-W	
648FT-LHC-W	
648FT-LVC-W	
648FT-TC-W	
648FT-XC-W	

- All article numbers of the accessories can be found on **p. 272 and 273**.
- Corners incl. flexible continuous electrical kit.



# LINE48V

ZUBEHÖR | ACCESSORIES | ACCESSORIES



Track type	description	Colour	Housing material	dimensions [mm]	cable length [mm]	weight [kg]	Material Number
SLIM TRACK 648ST	L-CONNECTOR HORIZONTAL	■ black [RAL 9005]	aluminium	L 73 / W 73 / H 27	-	0,16	<b>648ST-LC-B</b>
	L-CONNECTOR HORIZONTAL	□ white [RAL 9016]	aluminium	L 73 / W 73 / H 27	-	0,16	<b>648ST-LC-W</b>
	T-CONNECTOR	■ black [RAL 9005]	aluminium	L 96 / W 61 / H 26	-	0,18	<b>648ST-METC-B</b>
	T-CONNECTOR	□ white [RAL 9016]	aluminium	L 96 / W 61 / H 26	-	0,18	<b>648ST-METC-W</b>
	X-CONNECTOR	■ black [RAL 9005]	aluminium	L 96 / W 96 / H 26	-	0,18	<b>648ST-MEXC-B</b>
	X-CONNECTOR	□ white [RAL 9016]	aluminium	L 96 / W 96 / H 26	-	0,18	<b>648ST-MEXC-W</b>
	L-CORNER VERTICAL	■ black [RAL 9005]	aluminium	L 100 / W 100 / H 26	-	0,16	<b>648ST-LVC-B</b>
	L-CORNER VERTICAL	□ white [RAL 9016]	aluminium	L 100 / W 100 / H 26	-	0,16	<b>648ST-LVC-W</b>
	ENDCAP SET [2 PCS/SET]	■ black [RAL 9005]	plastic	L 27 / W 26 / H 11	-	0,03	<b>648ST-ECK-B</b>
	ENDCAP SET [2 PCS/SET]	□ white [RAL 9016]	plastic	L 27 / W 26 / H 11	-	0,03	<b>648ST-ECK-W</b>
	COVER	■ black [RAL 9005]	plastic	L 2000 / W 18 / H 17	-	0,18	<b>648ST-PC2000-B</b>
	COVER	□ white [RAL 9016]	plastic	L 2000 / W 18 / H 17	-	0,18	<b>648ST-PC2000-W</b>
	BASIC TRACK 648BT	L-CONNECTOR HORIZONTAL	■ black [RAL 9005]	aluminium	L 73 / W 73 / H 52	-	0,17
L-CONNECTOR HORIZONTAL		□ white [RAL 9016]	aluminium	L 73 / W 73 / H 52	-	0,17	<b>648BT-LC-W</b>
T-CONNECTOR		■ black [RAL 9005]	aluminium	L 96 / W 61 / H 52	-	0,19	<b>648BT-TC-B</b>
T-CONNECTOR		□ white [RAL 9016]	aluminium	L 96 / W 61 / H 52	-	0,19	<b>648BT-TC-W</b>
X-CONNECTOR		■ black [RAL 9005]	aluminium	L 96 / W 96 / H 52	-	0,19	<b>648BT-XC-B</b>
X-CONNECTOR		□ white [RAL 9016]	aluminium	L 96 / W 96 / H 52	-	0,19	<b>648BT-XC-W</b>
L-CORNER VERTICAL		■ black [RAL 9005]	aluminium	L 80 / W 80 / H 26	-	0,17	<b>648BT-LVC-B</b>
L-CORNER VERTICAL		□ white [RAL 9016]	aluminium	L 80 / W 80 / H 26	-	0,17	<b>648BT-LVC-W</b>
ENDCAP SET [2 PCS/SET]		■ black [RAL 9005]	plastic	L 52 / W 26 / H 11	-	0,04	<b>648BT-ECK-B</b>
ENDCAP SET [2 PCS/SET]		□ white [RAL 9016]	plastic	L 52 / W 26 / H 11	-	0,04	<b>648BT-ECK-W</b>
SLIM / BASIC TRACK	PENDANT SET [2 PCS/SET]	■ black [RAL 9005]	aluminium	L 33 / W 24 / H 8	-	0,07	<b>648TA-SK-B</b>
	SET [2 PCS/SET] INCL. CANOPY	■ black [RAL 9005]	metal	L 100 / W 55 / H 30	2000	0,31	<b>648TA-PIK-B</b>
	PENDANT SET [2 PCS/SET] INCL. CANOPY	□ white [RAL 9016]	metal	L 100 / W 55 / H 30	2000	0,31	<b>648TA-PIK-W</b>
	MECH. CONNECTION SET	■ black [RAL 9005]	aluminium	L 60 / W 24 / H 2	-	0,08	<b>648TA-MLC-B</b>

CORNERS / CONNECTORS INCL. FLEXIBLE CONTINUOUS KIT ELECTRICAL

Track type	description	Colour	Housing material	dimensions [mm]	cable length [mm]	weight [kg]	Material Number
H-TRACK 648HT	MECH. CONNECTION SET	■ black [RAL 9005]	aluminium	L 115 / W 23 / H 25	-	0,08	<b>648HT-LMC-B</b>
	CONNECTOR WITH PENDANT SET	■ black [RAL 9005]	aluminium	L 115 / W 23 / H 25	2000	0,09	<b>648HT-LCPK</b>
	PENDANT SET [2 PCS/SET]	■ black [RAL 9005]	aluminium	L 45 / W 23 / H 25	2000	0,09	<b>648HT-SK</b>
	PENDANT SET [1PCS/SET] INCL. CANOPY	■ black [RAL 9005]	aluminium	L 45 / W 23 / H 25	2000	0,34	<b>648HT-PK-H-B</b>
	PENDANT SET [1PCS/SET] INCL. CANOPY	□ white [RAL 9016]	aluminium	L 45 / W 23 / H 25	2000	0,34	<b>648HT-PK-H-W</b>
	FLEX. ELECTRICAL CONNECTION SET	■ black [RAL 9005]	plastic	L 95 / W 17 / H 16	-	0,06	<b>648HT-FECK-B</b>
	FLEX. ELECTRICAL CONNECTION SET	□ white [RAL 9016]	plastic	L 95 / W 17 / H 16	-	0,06	<b>648HT-FECK-W</b>
	ENDCAP SET [2 PCS/SET]	■ black [RAL 9005]	aluminium	L 90 / W 26 / H 15	-	0,05	<b>648HT-ECK-B</b>
	ENDCAP SET [2 PCS/SET]	□ white [RAL 9016]	aluminium	L 90 / W 26 / H 15	-	0,05	<b>648HT-ECK-W</b>
RECESSED FRAME TRACK 648FT	L-CORNER HORIZONTAL	■ black [RAL 9005]	aluminium	L 80 / W 80 / H 52	-	0,33	<b>648FT-LHC-B</b>
	L-CORNER HORIZONTAL	□ white [RAL 9016]	aluminium	L 80 / W 80 / H 52	-	0,33	<b>648FT-LHC-W</b>
	L-CORNER VERTICAL	■ black [RAL 9005]	aluminium	L 80 / W 80 / H 38	-	0,33	<b>648FT-LVC-B</b>
	L-CORNER VERTICAL	□ white [RAL 9016]	aluminium	L 80 / W 80 / H 38	-	0,33	<b>648FT-LVC-W</b>
	T-CONNECTOR	■ black [RAL 9005]	aluminium	L 120 / W 80 / H 38	-	0,35	<b>648FT-TC-B</b>
	T-CONNECTOR	□ white [RAL 9016]	aluminium	L 120 / W 80 / H 38	-	0,35	<b>648FT-TC-W</b>
	X-CONNECTOR	■ black [RAL 9005]	aluminium	L 120 / W 120 / H 38	-	0,35	<b>648FT-XC-B</b>
	X-CONNECTOR	□ white [RAL 9016]	aluminium	L 120 / W 120 / H 38	-	0,35	<b>648FT-XC-W</b>
	ENDCAP SET [2 PCS/SET]	■ black [RAL 9005]	plastic	L 38 / W 13 / H 52	-	0,04	<b>648FT-ECK-B</b>
	ENDCAP SET [2 PCS/SET]	□ white [RAL 9016]	plastic	L 38 / W 13 / H 52	-	0,04	<b>648FT-ECK-W</b>
	MOUNTING CLAMP [2 PCS]]	■ silver	aluminium	L 72 / W 20 / H 55	-	0,1	<b>648FT-MCK</b>
RECESSED FRAMELESS TRACK 648FL	L-CORNER HORIZONTAL	■ black [RAL 9005]	aluminium	L 100 / W 100 / H 52	-	0,33	<b>648FL-LHC-B</b>
	L-CORNER HORIZONTAL	□ white [RAL 9016]	aluminium	L 100 / W 100 / H 52	-	0,33	<b>648FL-LHC-W</b>
	L-CORNER VERTICAL	■ black [RAL 9005]	aluminium	L 100 / W 100 / H 52	-	0,33	<b>648FL-LVC-B</b>
	L-CORNER VERTICAL	□ white [RAL 9016]	aluminium	L 100 / W 100 / H 52	-	0,33	<b>648FL-LVC-W</b>
	T-CONNECTOR	■ black [RAL 9005]	aluminium	L 120 / W 100 / H 52	-	0,35	<b>648FL-TC-B</b>
	T-CONNECTOR	□ white [RAL 9016]	aluminium	L 120 / W 100 / H 52	-	0,35	<b>648FL-TC-W</b>
	X-CONNECTOR	■ black [RAL 9005]	aluminium	L 120 / W 120 / H 52	-	0,35	<b>648FL-XC-B</b>
	X-CONNECTOR	□ white [RAL 9016]	aluminium	L 120 / W 120 / H 52	-	0,35	<b>648FL-XC-W</b>
	ENDCAP SET [2 PCS/SET]	■ black [RAL 9005]	plastic	L 56 / W 26 / H 2	-	0,04	<b>648FL-ECK-B</b>
	ENDCAP SET [2 PCS/SET]	□ white [RAL 9016]	plastic	L 56 / W 26 / H 2	-	0,04	<b>648FL-ECK-W</b>
	MOUNTING CLAMP [2 PCS]]	■ black [RAL 9005]	aluminium	L 120 / W 36 / H 9	-	0,1	<b>648FL-MCK</b>
FOR ALL TRACKS	POWERFEEDER UNIT WITH CABLE	■ black [RAL 9005]	plastic	L 97 / W 17 / H 16	500	0,05	<b>648TA-PF05-B</b>
	POWERFEEDER UNIT WITH CABLE	□ white [RAL 9016]	plastic	L 97 / W 17 / H 16	500	0,05	<b>648TA-PF05-W</b>
	POWERFEEDER UNIT WITH CABLE	■ black [RAL 9005]	plastic	L 97 / W 17 / H 16	2000	0,05	<b>648TA-PF20-B</b>
	POWERFEEDER UNIT WITH CABLE	□ white [RAL 9005]	plastic	L 97 / W 17 / H 16	2000	0,05	<b>648TA-PF20-W</b>
	FLEXIBLE ELECTRICAL CONNECTION	■ black [RAL 9005]	plastic	L 229 / W 16 / H 17	-	0,05	<b>648TA-FECK-B</b>
	FLEXIBLE ELECTRICAL CONNECTION SET	□ white [RAL 9016]	plastic	L 229 / W 16 / H 17	-	0,05	<b>648TA-FECK-W</b>
	STRAIGHT ELECTRICAL CONNECTION SET	■ black [RAL 9005]	plastic	L 144 / W 16 / H 17	-	0,05	<b>648TA-SECK-B</b>
	RIGID ELECTRICAL CONNECTION SET	□ white [RAL 9016]	plastic	L 144 / W 16 / H 17	-	0,05	<b>648TA-SECK-W</b>
	COVER FOR 648BT/648HT/648FT/648FL TRACK	■ black [RAL 9005]	aluminium	L 2000 / W 24 / H 5	-	0,17	<b>648TA-AC2000-B</b>
	COVER FOR 648BT/648HT/648FT/648FL TRACK	□ white [RAL 9016]	aluminium	L 2000 / W 24 / H 6	-	0,17	<b>648TA-AC2000-W</b>

CORNERS / CONNECTORS INCL. FLEXIBLE CONTINUOUS KIT ELECTRICAL

# OVERVIEW

LEUCHTEN & TREIBER | LUMINAIRES & DRIVERS | *LUMINAIRES & DRIVER*

## LEUCHTEN | LUMINAIRES | *LUMINAIRES*



MEDIUM SPOT  
**276**



MEDIUM SPOT  
**277**



ZOOM SPOT  
**278**



FLAT SPOT  
**279**



FIXED SPOT  
**280**



FIXED SPOT  
**284**



LENS MODULE  
**288**



OPAL MODULE  
**289**



PRISM MODULE  
**290**

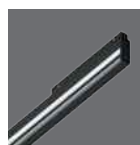

WALL WASHER  
**291**



PIEDALE  
**292**



CANALELLO  
**294**



TORTORETO  
**296**



ROBE  
**297**

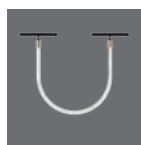

ROBE  
**298**

## TREIBER | DRIVERS | *DRIVER*



IN-TRACK 100 W  
**300**



IN-TRACK 250 W  
**300**

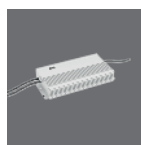

320 / 480 W  
**301**



SIGNAL CONTROLLER  
**301**



# LEUCHTEN & TREIBER

LUMINAIRES & DRIVERS

*LUMINAIRES & DRIVER*

# LINE48V

MEDIUM SPOT | MEDIUM SPOT | MEDIUM SPOT

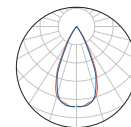

Die leistungsstarken und blendfreien Einzel Medium Spots für das modulare LINE48V Niedervolt-System mit Ø 40 mm Durchmesser versprechen eine Vielzahl von unterschiedlichen Konfigurationsmöglichkeiten. Die Farbtemperatur ist in 2700K, 3000K und 4000K wählbar und passt sich mit einem Farbwiedergabeindex >90 perfekt an höchste Anforderungen an. Die Lichteinsätze werden durch einen einfachen Klickmechanismus mit dem Profil verbunden, was ein hohes Maß an Flexibilität ohne den Einsatz von Werkzeug bietet. Um den Anforderungen professioneller Beleuchtungsaufgaben gerecht zu werden, können die Medium Spots sowohl mit on/off, als auch mit DALI-Treibern gewählt werden.

The powerful and glare-free Single cylindrical Medium Spot with Ø 40 mm diameter for the modular LINE48V Low Voltage promises a variety of different configurations options. The color temperature is available in 2700K, 3000K and 4000K and can be adapted to your requirements with a color rendering index >90. The light inserts will be connected to the profile by a simple click-in mechanism, which offers a high degree of flexibility without using any tools. To meet the requirements of professional lighting task, the Medium Spotlights can be selected with on/off as well as with DALI dimmable drivers.

Puissants et anti-éblouissants, les spots Medium simples pour le système modulaire LINE48V basse tension de Ø 40 mm de diamètre promettent une multitude de configurations différentes. La température de couleur est sélectionnable en 2700K, 3000K et 4000K et s'adapte parfaitement aux exigences les plus élevées avec un indice de rendu des couleurs >90. Les inserts d'éclairage sont reliés au profilé par un simple mécanisme d'encliquetage, ce qui offre une grande flexibilité sans avoir recours à des outils. Pour répondre aux exigences des tâches d'éclairage professionnelles, les Medium Spots peuvent être choisis avec des pilotes on/off ou DALI.

## ÜBERSICHT | OVERVIEW | VUE D'ENSEMBLE

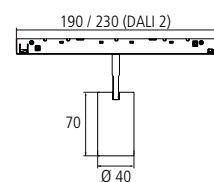

dimmable	colour	dimensions [mm]	colour temp. [K]	luminous flux [lm]	weight [kg]	material number
	■ black [RAL 9005]	Ø 40 / L 190 / H 130	2700	395	0,17	<b>648MS-459271-OOBLB</b>
	□ white [RAL 9016]	Ø 40 / L 190 / H 130	2700	395	0,17	<b>648MS-459271-OOWHB</b>
	■ black [RAL 9005]	Ø 40 / L 190 / H 130	3000	586	0,17	<b>648MS-459301-OOBLB</b>
	□ white [RAL 9016]	Ø 40 / L 190 / H 130	3000	586	0,17	<b>648MS-459301-OOWHB</b>
	■ black [RAL 9005]	Ø 40 / L 190 / H 130	4000	655	0,17	<b>648MS-459401-OOBLB</b>
	□ white [RAL 9016]	Ø 40 / L 190 / H 130	4000	655	0,17	<b>648MS-459401-OOWHB</b>
DALI2	■ black [RAL 9005]	Ø 40 / L 230 / H 130	2700	395	0,17	<b>648MS-459271-DDBLB</b>
	□ white [RAL 9016]	Ø 40 / L 230 / H 130	2700	395	0,17	<b>648MS-459271-DDWHB</b>
	■ black [RAL 9005]	Ø 40 / L 230 / H 130	3000	586	0,17	<b>648MS-459301-DDBLB</b>
	□ white [RAL 9016]	Ø 40 / L 230 / H 130	3000	586	0,17	<b>648MS-459301-DDWHB</b>
	■ black [RAL 9005]	Ø 40 / L 230 / H 130	4000	655	0,17	<b>648MS-459401-DDBLB</b>
	□ white [RAL 9016]	Ø 40 / L 230 / H 130	4000	655	0,17	<b>648MS-459401-DDWHB</b>

# LINE48V

MEDIUM SPOT | MEDIUM SPOT | MEDIUM SPOT

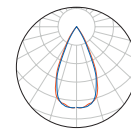

Die leistungsstarken und blendfreien Doppel Medium Spots für das modulare LINE48V Niedervolt-System mit Ø 40 mm Durchmesser versprechen eine Vielzahl von unterschiedlichen Konfigurationsmöglichkeiten. Die Farbtemperatur ist in 2700K, 3000K und 4000K wählbar und passt sich mit einem Farbwiedergabeindex >90 perfekt an höchste Anforderungen an. Die Lichteinsätze werden durch einen einfachen Klickmechanismus mit dem Profil verbunden, was ein hohes Maß an Flexibilität ohne den Einsatz von Werkzeug bietet. Um den Anforderungen professioneller Beleuchtungsaufgaben gerecht zu werden, können die Medium Spots sowohl mit on/off, als auch mit DALI-Treibern gewählt werden.

The powerful and glare-free Double cylindrical Medium Spot with Ø 40 mm diameter for the modular LINE48V Low Voltage promises a variety of different configurations options. The color temperature is available in 2700K, 3000K and 4000K and can be adapted to your requirements with a color rendering index >90. The light inserts will be connected to the profile by a simple click-in mechanism, which offers a high degree of flexibility without using any tools. To meet the requirements of professional lighting task, the Medium Spotlights can be selected with on/off as well as with DALI dimmable drivers.

Puissants et anti-éblouissants, les spots Medium doubles pour le système modulaire LINE48V basse tension de Ø 40 mm de diamètre promettent une multitude de configurations différentes. La température de couleur est sélectionnable en 2700K, 3000K et 4000K et s'adapte parfaitement aux exigences les plus élevées avec un indice de rendu des couleurs >90. Les inserts d'éclairage sont reliés au profilé par un simple mécanisme d'encliquetage, ce qui offre une grande flexibilité sans avoir recours à des outils. Pour répondre aux exigences des tâches d'éclairage professionnelles, les Medium Spots peuvent être choisis avec des pilotes on/off ou DALI.

## ÜBERSICHT | OVERVIEW | VUE D'ENSEMBLE



2 x 8 W

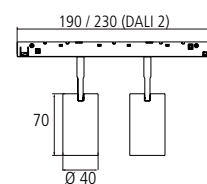

dimmable	colour	dimensions [mm]	colour temp. [K]	luminous flux [lm]	weight [kg]	material number
✗	■ black [RAL 9005]	Ø 40 / L 190 / H 130	2700	2 x 395	0,43	<b>648MD-459271-OOBLB</b>
	□ white [RAL 9016]	Ø 40 / L 190 / H 130	2700	2 x 395	0,43	<b>648MD-459271-OOWHB</b>
	■ black [RAL 9005]	Ø 40 / L 190 / H 130	3000	2 x 586	0,43	<b>648MD-459301-OOBLB</b>
	□ white [RAL 9016]	Ø 40 / L 190 / H 130	3000	2 x 586	0,43	<b>648MD-459301-OOWHB</b>
	■ black [RAL 9005]	Ø 40 / L 190 / H 130	4000	2 x 655	0,43	<b>648MD-459401-OOBLB</b>
	□ white [RAL 9016]	Ø 40 / L 190 / H 130	4000	2 x 655	0,43	<b>648MD-459401-OOWHB</b>
DALI 2	■ black [RAL 9005]	Ø 40 / L 230 / H 130	2700	2 x 395	0,43	<b>648MD-459271-DDBLB</b>
	□ white [RAL 9016]	Ø 40 / L 230 / H 130	2700	2 x 395	0,43	<b>648MD-459271-DDWHB</b>
	■ black [RAL 9005]	Ø 40 / L 230 / H 130	3000	2 x 586	0,43	<b>648MD-459301-DDBLB</b>
	□ white [RAL 9016]	Ø 40 / L 230 / H 130	3000	2 x 586	0,43	<b>648MD-459301-DDWHB</b>
	■ black [RAL 9005]	Ø 40 / L 230 / H 130	4000	2 x 655	0,43	<b>648MD-459401-DDBLB</b>
	□ white [RAL 9016]	Ø 40 / L 230 / H 130	4000	2 x 655	0,43	<b>648MD-459401-DDWHB</b>

# LINE48V

ZOOM SPOT | ZOOM SPOT | ZOOM SPOT

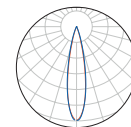

Der leistungsstarke und blendfreie Single-Zoom-Strahler mit Ø 55 mm Durchmesser für die modulare LINE48V Niedervolt-System verspricht eine Vielzahl von unterschiedlichen Konfigurationsmöglichkeiten. Die Farbtemperatur ist in 2700K, 3000K und 4000K erhältlich und kann mit einem Farbwiedergabeindex >90 an Ihre Anforderungen angepasst werden. Der LINE 48V Zoom Spot wird durch eine Variante mit optischem Zoom ergänzt, die es ermöglicht, jederzeit eine manuelle Anpassung der Abstrahlcharakteristik vorzunehmen. Die Lichteinsätze werden durch einen einfachen Einrastmechanismus mit dem Profil verbunden, was ein hohes Maß an Flexibilität ohne den Einsatz von Werkzeug bietet. Um den Anforderungen professioneller Beleuchtungsaufgaben gerecht zu werden, kann der Single Spotlight sowohl mit on/off- als auch mit DALI-Treibern gewählt werden.

The powerful and glare-free Single Zoom Spotlight with Ø 55 mm diameter for the modular LINE48V Low Voltage promises a variety of different configurations options. The color temperature is available in 2700K, 3000K and 4000K and can be adapted to your requirements with a color rendering index >90. LINE 48V Spot Inset MZ is complemented by a variant with an optical zoom, which makes it possible to make a manual adjustment of the beam characteristic at any time. The light inserts will be connected to the profile by a simple click-in mechanism, which offers a high degree of flexibility without using any tools. To meet the requirements of professional lighting task, the Single Spotlight can be selected with on/off as well as with DALI drivers.

Le projecteur puissant et non éblouissant à zoom unique d'un diamètre de 55 mm pour la LINE48V Low Voltage modulaire offre de nombreuses possibilités de configuration. La température de couleur est disponible en 2700K, 3000K et 4000K et peut être adaptée à vos besoins avec un indice de rendu des couleurs >90. LINE 48V Spot Inset MZ est complété par une variante avec zoom optique, qui permet d'effectuer un réglage manuel des caractéristiques du faisceau à tout moment. Les inserts lumineux seront connectés au profilé par un simple mécanisme d'encliquetage, ce qui offre un haut degré de flexibilité sans l'utilisation d'outils. Pour répondre aux exigences d'un éclairage professionnel, le Single Spotlight peut être sélectionné avec des pilotes on/off ou DALI.

## ÜBERSICHT | OVERVIEW | VUE D'ENSEMBLE

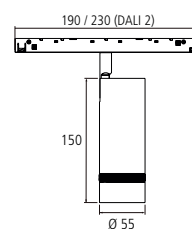

dimmable	colour	dimensions [mm]	colour temp. [K]	luminous flux [lm]	weight [kg]	material number
✗	■ black [RAL 9005]	Ø 55 / L 190 / H 200	2700	871	0,4	648MZ-ZO9271-OOBLB
	□ white [RAL 9016]	Ø 55 / L 190 / H 200	2700	871	0,4	648MZ-ZO9271-OOWHB
	■ black [RAL 9005]	Ø 55 / L 190 / H 200	3000	926	0,4	648MZ-ZO9301-OOBLB
	□ white [RAL 9016]	Ø 55 / L 190 / H 200	3000	926	0,4	648MZ-ZO9301-OOWHB
	■ black [RAL 9005]	Ø 55 / L 190 / H 200	4000	966	0,4	648MZ-ZO9401-OOBLB
	□ white [RAL 9016]	Ø 55 / L 190 / H 200	4000	966	0,4	648MZ-ZO9401-OOWHB
DALI 2	■ black [RAL 9005]	Ø 55 / L 230 / H 200	2700	871	0,4	648MZ-ZO9271-DDBLB
	□ white [RAL 9016]	Ø 55 / L 230 / H 200	2700	871	0,4	648MZ-ZO9271-DDWHB
	■ black [RAL 9005]	Ø 55 / L 230 / H 200	3000	926	0,4	648MZ-ZO9301-DDBLB
	□ white [RAL 9016]	Ø 55 / L 230 / H 200	3000	926	0,4	648MZ-ZO9301-DDWHB
	■ black [RAL 9005]	Ø 55 / L 230 / H 200	4000	966	0,4	648MZ-ZO9401-DDBLB
	□ white [RAL 9016]	Ø 55 / L 230 / H 200	4000	966	0,4	648MZ-ZO9401-DDWHB

# LINE48V

FLAT SPOT | FLAT SPOT | FLAT SPOT

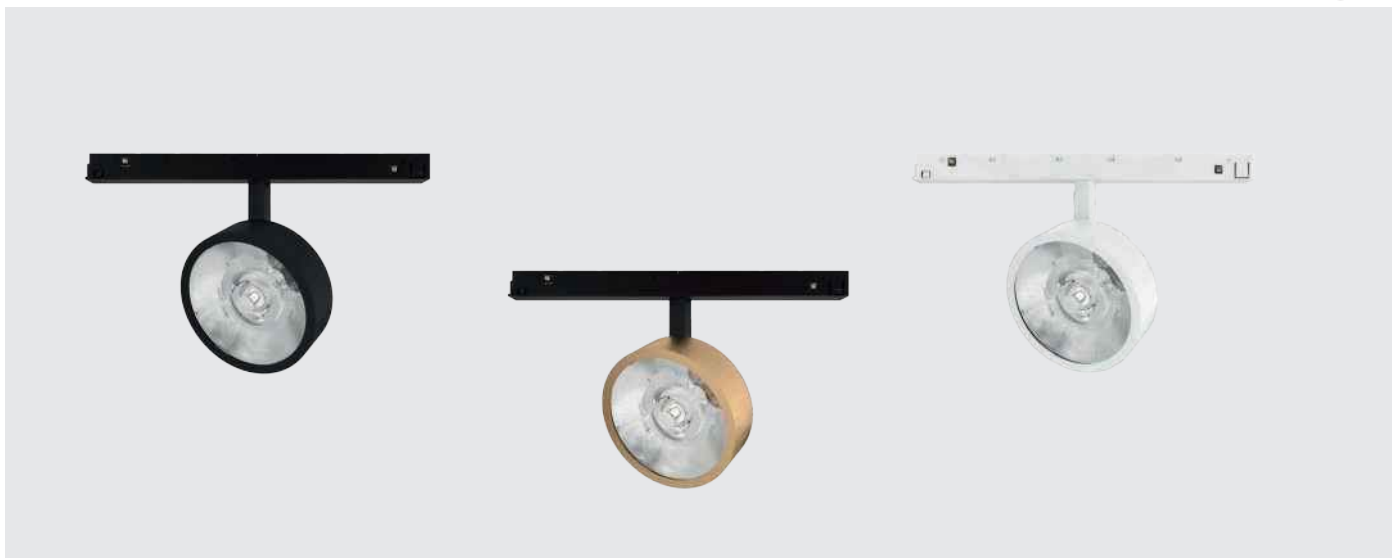
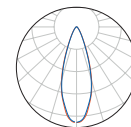

Der leistungsstarke Single Flat Spot mit Ø 96 mm Durchmesser für das modulare LINE48V Niedervolt-System verspricht eine Vielzahl von unterschiedlichen Konfigurationsmöglichkeiten. Die Farbtemperatur ist in 2700K, 3000K und 4000K erhältlich und kann mit einem Farbwiedergabeindex >90 an Ihre Anforderungen angepasst werden. Mit bis zu 858 Lumen bei einer minimalen Bauhöhe von nur 30mm, bietet der Flat Spot eine leistungsstarke Beleuchtungslösung. LINE48V Spotlight Inset SF ist in den Farben schwarz und weiß pulverbeschichtet, sowie in einer eleganten goldenen gebürsteten Oberfläche erhältlich. Die Lichteinsätze werden durch einen einfachen Einrastmechanismus mit dem Profil verbunden, der ein hohes Maß an Flexibilität ohne den Einsatz von Werkzeugen bietet. Um den Anforderungen professioneller Beleuchtungsaufgaben gerecht zu werden, kann der Single Spotlight sowohl mit on/off-, als auch mit DALI-Treibern gewählt werden.

The powerful Single Flat Spot with Ø 96 mm diameter for the modular 48V Low Voltage promises a variety of different configurations options. The color temperature is available in 2700K, 3000K and 4000K and can be adapted to your requirements with a color rendering index >90. With up to 858 lumens with a minimum height of just 30mm, the Flat Spot offers are powerful lighting solutions. LINE48V Spotlight Inset SF is available in a powder-coated black and white, as well as in an elegant golden brushed finish. The light inserts will be connected to the profile by a simple click-in mechanism, which offers a high degree of flexibility without using any tools. To meet the requirements of professional lighting task, the Single Spotlight can be selected with on/off as well as with DALI drivers.

Le puissant Single Flat Spot d'un diamètre de 96 mm pour le système modulaire 48V Low Voltage promet une variété de configurations différentes. La température de couleur est disponible en 2700K, 3000K et 4000K et peut être adaptée à vos besoins avec un indice de rendu des couleurs >90. Avec jusqu'à 858 lumens pour une hauteur minimale de seulement 30 mm, le Flat Spot offre des solutions d'éclairage puissantes. LINE48V Spot Inset SF est disponible en noir et blanc avec revêtement par poudre, ainsi que dans une élégante finition dorée brossée. Les inserts lumineux seront connectés au profilé par un simple mécanisme d'encliquetage, ce qui offre un haut degré de flexibilité sans l'utilisation d'outils. Pour répondre aux exigences d'un éclairage professionnel, le Single Spotlight peut être choisi avec des pilotes on/off ou DALI.

## ÜBERSICHT | OVERVIEW | VUE D'ENSEMBLE

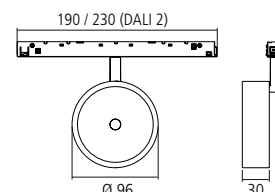

dimmable	colour	dimensions [mm]	colour temp. [K]	luminous flux [lm]	weight [kg]	material number
	■ black [RAL 9005]	Ø 96 / L 190 / H 141	2700	724	0,45	<b>648SF-359271-OOBLB</b>
	□ white [RAL 9016]	Ø 96 / L 190 / H 141	2700	724	0,45	<b>648SF-359271-OOWHW</b>
	■ gold	Ø 96 / L 190 / H 141	2700	724	0,45	<b>648SF-359271-OOBLG</b>
	■ black [RAL 9005]	Ø 96 / L 190 / H 141	3000	770	0,45	<b>648SF-359301-OOBLB</b>
	□ white [RAL 9016]	Ø 96 / L 190 / H 141	3000	770	0,45	<b>648SF-359301-OOWHW</b>
	■ gold	Ø 96 / L 190 / H 141	3000	770	0,45	<b>648SF-359301-OOBLG</b>
DALI 2	■ black [RAL 9005]	Ø 96 / L 190 / H 141	4000	858	0,45	<b>648SF-359401-OOBLB</b>
	□ white [RAL 9016]	Ø 96 / L 190 / H 141	4000	858	0,45	<b>648SF-359401-OOWHW</b>
	■ black [RAL 9005]	Ø 96 / L 230 / H 141	2700	724	0,45	<b>648SF-359271-DDBLB</b>
	□ white [RAL 9016]	Ø 96 / L 230 / H 141	2700	724	0,45	<b>648SF-359271-DDWHW</b>
	■ gold	Ø 96 / L 230 / H 141	2700	724	0,45	<b>648SF-359271-DDBLG</b>
	■ black [RAL 9005]	Ø 96 / L 230 / H 141	3000	770	0,45	<b>648SF-359301-DDBLB</b>
DALI 2	□ white [RAL 9016]	Ø 96 / L 230 / H 141	3000	770	0,45	<b>648SF-359301-DDWHW</b>
	■ gold	Ø 96 / L 230 / H 141	3000	770	0,45	<b>648SF-359301-DDBLG</b>
	■ black [RAL 9005]	Ø 96 / L 230 / H 141	4000	858	0,45	<b>648SF-359401-DDBLB</b>
	□ white [RAL 9016]	Ø 96 / L 230 / H 141	4000	858	0,45	<b>648SF-359401-DDWHW</b>

# LINE48V

FIXED SPOT | FIXED SPOT | FIXED SPOT

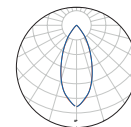

Die leistungsstarken und blendfreien Einzel Fixed Spots mit Ø 72 mm Durchmesser für das modulare LINE48V Niedervolt-System versprechen eine Vielzahl von unterschiedlichen Konfigurationsmöglichkeiten. Die Farbtemperatur ist in 2700K, 3000K und 4000K erhältlich und kann mit einem Farbwiedergabeindex >90 an Ihre Anforderungen angepasst werden. Durch den tiefen Einbau der LED in das Gehäuse bieten die LINE48V Fixed Spot Einsätze einen hohen Sehkomfort und eine blendfreie Ausleuchtung mit einem UGR-Wert <19. Darüber hinaus können pro Modell fünf verschiedenfarbige Reflektoren frei gewählt werden, um das perfekte Gestaltungselement für ein stimmungsvolles Ambiente zu schaffen. Die Lichteinsätze werden durch einen einfachen Einrastmechanismus mit dem Profil verbunden, der ein hohes Maß an Flexibilität ohne den Einsatz von Werkzeug bietet. Um den Anforderungen professioneller Beleuchtungsaufgaben gerecht zu werden, können die festen Spots sowohl mit on/off- als auch mit DALI-Treibern gewählt werden.

The powerful and glare-free Single Fixed Spots with Ø 72 mm diameter for the modular LINE48V Low Voltage System promises a variety of different configurations options. The color temperature is available in 2700K, 3000K and 4000K and can be adapted to your requirements with a color rendering index >90. Due to the fact that the LED is installed deep in the housing, the LINE48V Fixed Spot Inserts offer a high visual comfort and a glare-free illumination with a UGR value <19. Furthermore, five different colored reflectors can be freely selected per model to create the perfect design element for an atmospheric ambience. The light inserts will be connected to the profile by a simple click-in mechanism, which offers a high degree of flexibility without using any tools. To meet the requirements of professional lighting task, the fixed Spots can be selected with on/off as well as with DALI drivers.

Les spots fixes simples puissants et non éblouissants d'un diamètre de 72 mm pour la basse tension modulaire LINE48V offrent de nombreuses possibilités de configuration. La température de couleur est disponible en 2700K, 3000K et 4000K et peut être adaptée à vos besoins avec un indice de rendu des couleurs >90. Du fait que la LED est installée profondément dans le boîtier, les LINE48V Fixed Spot Inserts offrent un confort visuel élevé et un éclairage sans éblouissement avec une valeur UGR <19. De plus, cinq réflecteurs de couleurs différentes peuvent être choisis librement par modèle afin de créer l'élément de design parfait pour une ambiance atmosphérique. Les modules d'éclairage seront connectés au profilé par un simple mécanisme d'encliquetage, ce qui offre un haut degré de flexibilité sans l'utilisation d'outils. Pour répondre aux exigences d'un éclairage professionnel, les Spots fixes peuvent être sélectionnés avec des pilotes on/off ou DALI.

## ÜBERSICHT | OVERVIEW | VUE D'ENSEMBLE

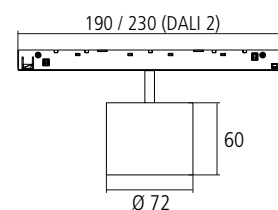

HOUSING COLOUR	
schwarz   black   noir RAL 9005	
weiß   white   blanc RAL 9016	

REFLECTOR COLOUR	
specular 648DR-S	white 648DR-W
black 648DR-B	gold 648DR-G
chrome black 648DR-C	



dimmable	spot type	Colour	dimensions [mm]	colour temp. [K]	luminous flux [lm]	weight [kg]	material number
not dimmable							
	■ black [RAL 9005]	■ specular	Ø 72 / L 190 / H 105	2700	735	0,45	648DS-509271-OOBLS
		■ black	Ø 72 / L 190 / H 105	2700	697	0,45	648DS-509271-OOBLB
		■ chrome black	Ø 72 / L 190 / H 105	2700	707	0,45	648DS-509271-OOBLC
		□ white	Ø 72 / L 190 / H 105	2700	728	0,45	648DS-509271-OOBLW
		■ gold	Ø 72 / L 190 / H 105	2700	730	0,45	648DS-509271-OOBLG
	□ white [RAL 9016]	■ specular	Ø 72 / L 190 / H 105	2700	735	0,45	648DS-509271-OOWHS
		■ black	Ø 72 / L 190 / H 105	2700	697	0,45	648DS-509271-OOWHB
		■ chrome black	Ø 72 / L 190 / H 105	2700	707	0,45	648DS-509271-OOWHC
		□ white	Ø 72 / L 190 / H 105	2700	728	0,45	648DS-509271-OOWHW
		■ gold	Ø 72 / L 190 / H 105	2700	730	0,45	648DS-509271-OOWHG
	■ black [RAL 9005]	■ specular	Ø 72 / L 190 / H 105	3000	782	0,45	648DS-509301-OOBLS
		■ black	Ø 72 / L 190 / H 105	3000	741	0,45	648DS-509301-OOBLB
		■ chrome black	Ø 72 / L 190 / H 105	3000	752	0,45	648DS-509301-OOBLC
		□ white	Ø 72 / L 190 / H 105	3000	774	0,45	648DS-509301-OOBLW
		■ gold	Ø 72 / L 190 / H 105	3000	777	0,45	648DS-509301-OOBLG
	□ white [RAL 9016]	■ specular	Ø 72 / L 190 / H 105	3000	782	0,45	648DS-509301-OOWHS
		■ black	Ø 72 / L 190 / H 105	3000	741	0,45	648DS-509301-OOWHB
		■ chrome black	Ø 72 / L 190 / H 105	3000	752	0,45	648DS-509301-OOWHC
		□ white	Ø 72 / L 190 / H 105	3000	774	0,45	648DS-509301-OOWHW
		■ gold	Ø 72 / L 190 / H 105	3000	777	0,45	648DS-509301-OOWHG
■ black [RAL 9005]	■ specular	Ø 72 / L 190 / H 105	4000	845	0,45	648DS-509401-OOBLS	
	■ black	Ø 72 / L 190 / H 105	4000	801	0,45	648DS-509401-OOBLB	
	■ chrome black	Ø 72 / L 190 / H 105	4000	813	0,45	648DS-509401-OOBLC	
	□ white	Ø 72 / L 190 / H 105	4000	837	0,45	648DS-509401-OOBLW	
	■ gold	Ø 72 / L 190 / H 105	4000	840	0,45	648DS-509401-OOBLG	
□ white [RAL 9016]	■ specular	Ø 72 / L 190 / H 105	4000	845	0,45	648DS-509401-OOWHS	
	■ black	Ø 72 / L 190 / H 105	4000	801	0,45	648DS-509401-OOWHB	
	■ chrome black	Ø 72 / L 190 / H 105	4000	813	0,45	648DS-509401-OOWHC	
	□ white	Ø 72 / L 190 / H 105	4000	837	0,45	648DS-509401-OOWHW	
	■ gold	Ø 72 / L 190 / H 105	4000	840	0,45	648DS-509401-OOWHG	



# LINE48V

FIXED SPOT | FIXED SPOT | *FIXED SPOT*



dimnable	spot type	colour	dimensions [mm]	colour temp. [K]	luminous flux [lm]	weight [kg]	material number
dimnable   dali 2							
	■ black [RAL 9005]	■ specular	Ø 72 / L 230 / H 105	2700	735	0,46	<b>648DS-509271-DDBLS</b>
		■ black	Ø 72 / L 230 / H 105	2700	697	0,46	<b>648DS-509271-DDBLB</b>
		■ chrome black	Ø 72 / L 230 / H 105	2700	707	0,46	<b>648DS-509271-DDBLC</b>
		□ white	Ø 72 / L 230 / H 105	2700	728	0,46	<b>648DS-509271-DDBLW</b>
		■ gold	Ø 72 / L 230 / H 105	2700	730	0,46	<b>648DS-509271-DDBLG</b>
	□ white [RAL 9016]	■ specular	Ø 72 / L 230 / H 105	2700	735	0,46	<b>648DS-509271-DDWHS</b>
		■ black	Ø 72 / L 230 / H 105	2700	697	0,46	<b>648DS-509271-DDWHB</b>
		■ chrome black	Ø 72 / L 230 / H 105	2700	707	0,46	<b>648DS-509271-DDWHC</b>
		□ white	Ø 72 / L 230 / H 105	2700	728	0,46	<b>648DS-509271-DDWHW</b>
		■ gold	Ø 72 / L 230 / H 105	2700	730	0,46	<b>648DS-509271-DDWHG</b>
■ black [RAL 9005]	■ specular	Ø 72 / L 230 / H 105	3000	782	0,46	<b>648DS-509301-DDBLS</b>	
	■ black	Ø 72 / L 230 / H 105	3000	741	0,46	<b>648DS-509301-DDBLB</b>	
	■ chrome black	Ø 72 / L 230 / H 105	3000	752	0,46	<b>648DS-509301-DDBLC</b>	
	□ white	Ø 72 / L 230 / H 105	3000	774	0,46	<b>648DS-509301-DDBLW</b>	
	■ gold	Ø 72 / L 230 / H 105	3000	777	0,46	<b>648DS-509301-DDBLG</b>	
	□ white [RAL 9016]	■ specular	Ø 72 / L 230 / H 105	3000	782	0,46	<b>648DS-509301-DDWHS</b>
		■ black	Ø 72 / L 230 / H 105	3000	741	0,46	<b>648DS-509301-DDWHB</b>
		■ chrome black	Ø 72 / L 230 / H 105	3000	752	0,46	<b>648DS-509301-DDWHC</b>
		□ white	Ø 72 / L 230 / H 105	3000	774	0,46	<b>648DS-509301-DDWHW</b>
		■ gold	Ø 72 / L 230 / H 105	3000	777	0,46	<b>648DS-509301-DDWHG</b>
■ black [RAL 9005]	■ specular	Ø 72 / L 230 / H 105	4000	845	0,46	<b>648DS-509401-DDBLS</b>	
	■ black	Ø 72 / L 230 / H 105	4000	801	0,46	<b>648DS-509401-DDBLB</b>	
	■ chrome black	Ø 72 / L 230 / H 105	4000	813	0,46	<b>648DS-509401-DDBLC</b>	
	□ white	Ø 72 / L 230 / H 105	4000	837	0,46	<b>648DS-509401-DDBLW</b>	
	■ gold	Ø 72 / L 230 / H 105	4000	840	0,46	<b>648DS-509401-DDBLG</b>	
□ white [RAL 9016]	■ specular	Ø 72 / L 230 / H 105	4000	845	0,46	<b>648DS-509401-DDWHS</b>	
	■ black	Ø 72 / L 230 / H 105	4000	801	0,46	<b>648DS-509401-DDWHB</b>	
	■ chrome black	Ø 72 / L 230 / H 105	4000	813	0,46	<b>648DS-509401-DDWHC</b>	
	□ white	Ø 72 / L 230 / H 105	4000	837	0,46	<b>648DS-509401-DDWHW</b>	
	■ gold	Ø 72 / L 230 / H 105	4000	840	0,46	<b>648DS-509401-DDWHG</b>	

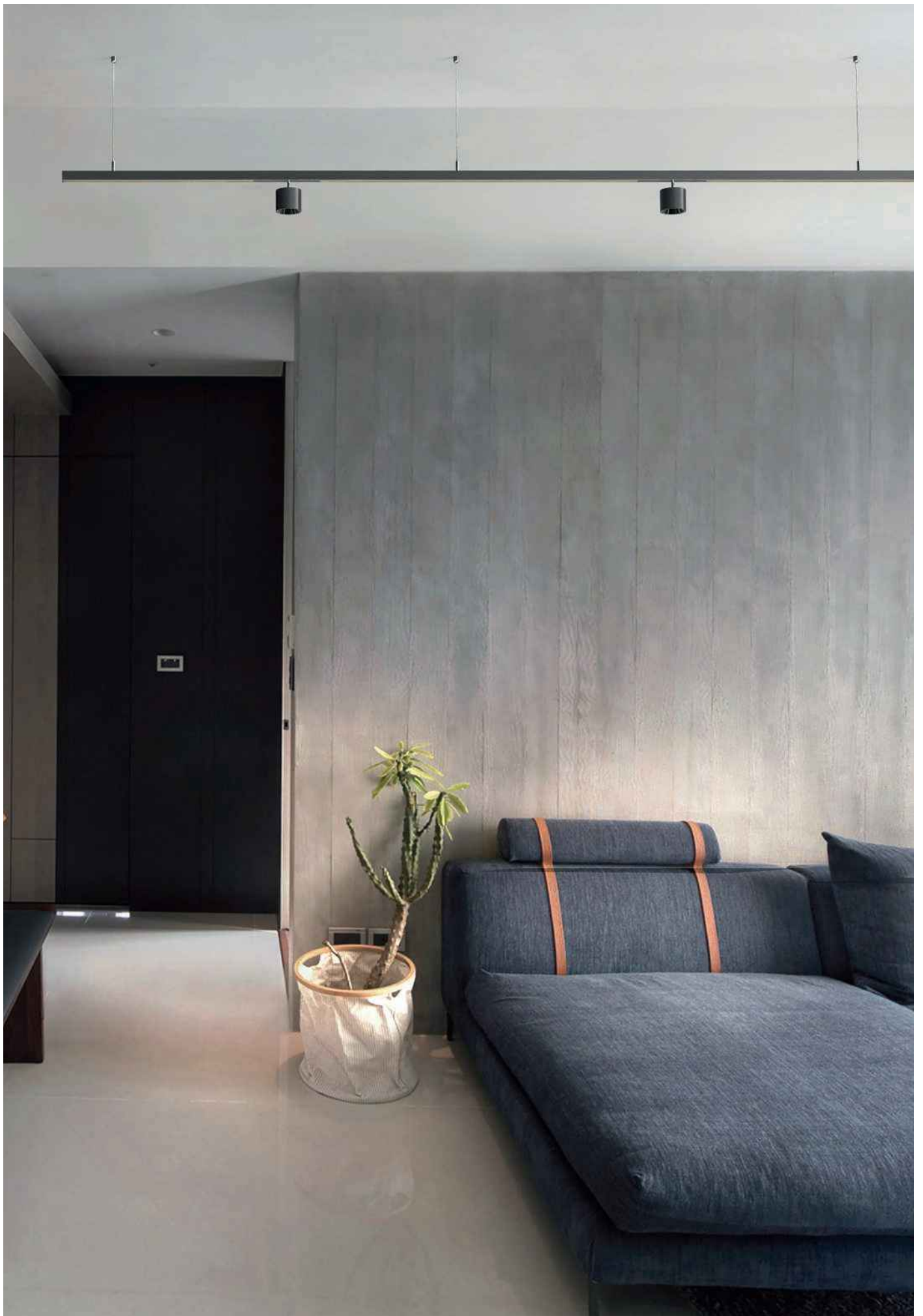

# LINE48V

FIXED SPOT | FIXED SPOT | FIXED SPOT

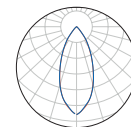

Die leistungsstarken und blendfreien Doppel Fixed Spots mit Ø 72 mm Durchmesser für das modulare LINE48V Niedervolt-System versprechen eine Vielzahl von unterschiedlichen Konfigurationsmöglichkeiten. Die Farbtemperatur ist in 2700K, 3000K und 4000K erhältlich und kann mit einem Farbwiedergabeindex >90 an Ihre Anforderungen angepasst werden. Durch den tiefen Einbau der LED in das Gehäuse bieten die LINE48V Fixed Spot Einsätze einen hohen Sehkomfort und eine blendfreie Ausleuchtung mit einem UGR-Wert <19. Darüber hinaus können pro Modell fünf verschiedenfarbige Reflektoren frei gewählt werden, um das perfekte Gestaltungselement für ein stimmungsvolles Ambiente zu schaffen. Die Lichteinsätze werden durch einen einfachen Einrastmechanismus mit dem Profil verbunden, der ein hohes Maß an Flexibilität ohne den Einsatz von Werkzeug bietet. Um den Anforderungen professioneller Beleuchtungsaufgaben gerecht zu werden, können die festen Spots sowohl mit on/off- als auch mit DALI-Treibern gewählt werden.

The powerful and glare-free Double Fixed Spots with Ø 72 mm diameter for the modular LINE48V Low Voltage promises a variety of different configurations options. The color temperature is available in 2700K, 3000K and 4000K and can be adapted to your requirements with a color rendering index >90. Due to the fact that the LED is installed deep in the housing, the LINE48V Fixed Spot Inserts offer a high visual comfort and a glare-free illumination with a UGR value <19. Furthermore, five different colored reflectors can be freely selected per model to create the perfect design element for an atmospheric ambience. The light inserts will be connected to the profile by a simple click-in mechanism, which offers a high degree of flexibility without using any tools. To meet the requirements of professional lighting task, the fixed Spots can be selected with on/off as well as with DALI drivers.

Les spots fixes doubles puissants et non éblouissants d'un diamètre de 72 mm pour la basse tension modulaire LINE48V offrent de nombreuses possibilités de configuration. La température de couleur est disponible en 2700K, 3000K et 4000K et peut être adaptée à vos besoins avec un indice de rendu des couleurs >90. Du fait que la LED est installée profondément dans le boîtier, les LINE48V Fixed Spot Inserts offrent un confort visuel élevé et un éclairage sans éblouissement avec une valeur UGR <19. De plus, cinq réflecteurs de couleurs différentes peuvent être choisis librement par modèle afin de créer l'élément de design parfait pour une ambiance atmosphérique. Les modules d'éclairage seront connectés au profilé par un simple mécanisme d'encliquetage, ce qui offre un haut degré de flexibilité sans l'utilisation d'outils. Pour répondre aux exigences d'un éclairage professionnel, les Spots fixes peuvent être sélectionnés avec des pilotes on/off ou DALI.

## ÜBERSICHT | OVERVIEW | VUE D'ENSEMBLE



2 x 10 W

50°

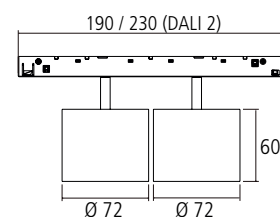

### HOUSING COLOUR

schwarz | black | noir  
RAL 9005



weiß | white | blanc  
RAL 9016



### REFLECTOR COLOUR

specular 648DR-S



white 648DR-W



black 648DR-B



gold 648DR-G



chrome black 648DR-C





dimmable	spot type	colour	dimensions [mm]	colour temp. [K]	luminous flux [lm]	weight [kg]	material number
not dimmable							
	■ black [RAL 9005]	■ specular	Ø 72 / L 190 / H 105	2700	2 x 736	0,68	<b>648DD-509271-OOBLS</b>
		■ black	Ø 72 / L 190 / H 105	2700	2 x 697	0,68	<b>648DD-509271-OOBLB</b>
		■ chrome black	Ø 72 / L 190 / H 105	2700	2 x 707	0,68	<b>648DD-509271-OOBLC</b>
		□ white	Ø 72 / L 190 / H 105	2700	2 x 728	0,68	<b>648DD-509271-OOBLW</b>
		■ gold	Ø 72 / L 190 / H 105	2700	2 x 730	0,68	<b>648DD-509271-OOBLG</b>
	■ white [RAL 9016]	■ specular	Ø 72 / L 190 / H 105	2700	2 x 736	0,68	<b>648DD-509271-OOWHS</b>
		■ black	Ø 72 / L 190 / H 105	2700	2 x 697	0,68	<b>648DD-509271-OOWHB</b>
		■ chrome black	Ø 72 / L 190 / H 105	2700	2 x 707	0,68	<b>648DD-509271-OOWHC</b>
		□ white	Ø 72 / L 190 / H 105	2700	2 x 728	0,68	<b>648DD-509271-OOWHW</b>
		■ gold	Ø 72 / L 190 / H 105	2700	2 x 730	0,68	<b>648DD-509271-OOWHG</b>
	■ black [RAL 9005]	■ specular	Ø 72 / L 190 / H 105	3000	2 x 782	0,68	<b>648DD-509301-OOBLS</b>
		■ black	Ø 72 / L 190 / H 105	3000	2 x 741	0,68	<b>648DD-509301-OOBLB</b>
		■ chrome black	Ø 72 / L 190 / H 105	3000	2 x 752	0,68	<b>648DD-509301-OOBLC</b>
		□ white	Ø 72 / L 190 / H 105	3000	2 x 774	0,68	<b>648DD-509301-OOBLW</b>
		■ gold	Ø 72 / L 190 / H 105	3000	2 x 777	0,68	<b>648DD-509301-OOBLG</b>
	■ white [RAL 9016]	■ specular	Ø 72 / L 190 / H 105	3000	2 x 782	0,68	<b>648DD-509301-OOWHS</b>
		■ black	Ø 72 / L 190 / H 105	3000	2 x 741	0,68	<b>648DD-509301-OOWHB</b>
		■ chrome black	Ø 72 / L 190 / H 105	3000	2 x 752	0,68	<b>648DD-509301-OOWHC</b>
		□ white	Ø 72 / L 190 / H 105	3000	2 x 774	0,68	<b>648DD-509301-OOWHW</b>
		■ gold	Ø 72 / L 190 / H 105	3000	2 x 777	0,68	<b>648DD-509301-OOWHG</b>
■ black [RAL 9005]	■ specular	Ø 72 / L 190 / H 105	4000	2 x 845	0,68	<b>648DD-509401-OOBLS</b>	
	■ black	Ø 72 / L 190 / H 105	4000	2 x 801	0,68	<b>648DD-509401-OOBLB</b>	
	■ chrome black	Ø 72 / L 190 / H 105	4000	2 x 813	0,68	<b>648DD-509401-OOBLC</b>	
	□ white	Ø 72 / L 190 / H 105	4000	2 x 837	0,68	<b>648DD-509401-OOBLW</b>	
	■ gold	Ø 72 / L 190 / H 105	4000	2 x 840	0,68	<b>648DD-509401-OOBLG</b>	
■ white [RAL 9016]	■ specular	Ø 72 / L 190 / H 105	4000	2 x 845	0,68	<b>648DD-509401-OOWHS</b>	
	■ black	Ø 72 / L 190 / H 105	4000	2 x 801	0,68	<b>648DD-509401-OOWHB</b>	
	■ chrome black	Ø 72 / L 190 / H 105	4000	2 x 813	0,68	<b>648DD-509401-OOWHC</b>	
	□ white	Ø 72 / L 190 / H 105	4000	2 x 837	0,68	<b>648DD-509401-OOWHW</b>	
	■ gold	Ø 72 / L 190 / H 105	4000	2 x 840	0,68	<b>648DD-509401-OOWHG</b>	

# LINE48V

FIXED SPOT | FIXED SPOT | *FIXED SPOT*



dimnable	spot type	colour	dimensions [mm]	colour temp. [K]	luminous flux [lm]	weight [kg]	material number
dimnable   dali 2							
	■ black [RAL 9005]	■ specular	Ø 72 / L 230 / H 105	2700	2 x 736	0,68	<b>648DD-509271-DBBLS</b>
		■ black	Ø 72 / L 230 / H 105	2700	2 x 697	0,68	<b>648DD-509271-DBBLB</b>
		■ chrome black	Ø 72 / L 230 / H 105	2700	2 x 707	0,68	<b>648DD-509271-DBBLC</b>
		□ white	Ø 72 / L 230 / H 105	2700	2 x 728	0,68	<b>648DD-509271-DBBLW</b>
		■ gold	Ø 72 / L 230 / H 105	2700	2 x 730	0,68	<b>648DD-509271-DBBLG</b>
	□ white [RAL 9016]	■ specular	Ø 72 / L 230 / H 105	2700	2 x 736	0,68	<b>648DD-509271-DDWHS</b>
		■ black	Ø 72 / L 230 / H 105	2700	2 x 697	0,68	<b>648DD-509271-DDWHB</b>
		■ chrome black	Ø 72 / L 230 / H 105	2700	2 x 707	0,68	<b>648DD-509271-DDWHC</b>
		□ white	Ø 72 / L 230 / H 105	2700	2 x 728	0,68	<b>648DD-509271-DDWHW</b>
		■ gold	Ø 72 / L 230 / H 105	2700	2 x 730	0,68	<b>648DD-509271-DDWHG</b>
■ black [RAL 9005]	■ specular	Ø 72 / L 230 / H 105	3000	2 x 782	0,68	<b>648DD-509301-DBBLS</b>	
	■ black	Ø 72 / L 230 / H 105	3000	2 x 741	0,68	<b>648DD-509301-DBBLB</b>	
	■ chrome black	Ø 72 / L 230 / H 105	3000	2 x 752	0,68	<b>648DD-509301-DBBLC</b>	
	□ white	Ø 72 / L 230 / H 105	3000	2 x 774	0,68	<b>648DD-509301-DBBLW</b>	
	■ gold	Ø 72 / L 230 / H 105	3000	2 x 777	0,68	<b>648DD-509301-DBBLG</b>	
	□ white [RAL 9016]	■ specular	Ø 72 / L 230 / H 105	3000	2 x 782	0,68	<b>648DD-509301-DDWHS</b>
		■ black	Ø 72 / L 230 / H 105	3000	2 x 741	0,68	<b>648DD-509301-DDWHB</b>
		■ chrome black	Ø 72 / L 230 / H 105	3000	2 x 752	0,68	<b>648DD-509301-DDWHC</b>
		□ white	Ø 72 / L 230 / H 105	3000	2 x 774	0,68	<b>648DD-509301-DDWHW</b>
		■ gold	Ø 72 / L 230 / H 105	3000	2 x 777	0,68	<b>648DD-509301-DDWHG</b>
■ black [RAL 9005]	■ specular	Ø 72 / L 230 / H 105	4000	2 x 845	0,68	<b>648DD-509401-DBBLS</b>	
	■ black	Ø 72 / L 230 / H 105	4000	2 x 801	0,68	<b>648DD-509401-DBBLB</b>	
	■ chrome black	Ø 72 / L 230 / H 105	4000	2 x 813	0,68	<b>648DD-509401-DBBLC</b>	
	□ white	Ø 72 / L 230 / H 105	4000	2 x 837	0,68	<b>648DD-509401-DBBLW</b>	
	■ gold	Ø 72 / L 230 / H 105	4000	2 x 840	0,68	<b>648DD-509401-DBBLG</b>	
□ white [RAL 9016]	■ specular	Ø 72 / L 230 / H 105	4000	2 x 845	0,68	<b>648DD-509401-DDWHS</b>	
	■ black	Ø 72 / L 230 / H 105	4000	2 x 801	0,68	<b>648DD-509401-DDWHB</b>	
	■ chrome black	Ø 72 / L 230 / H 105	4000	2 x 813	0,68	<b>648DD-509401-DDWHC</b>	
	□ white	Ø 72 / L 230 / H 105	4000	2 x 837	0,68	<b>648DD-509401-DDWHW</b>	
	■ gold	Ø 72 / L 230 / H 105	4000	2 x 840	0,68	<b>648DD-509401-DDWHG</b>	



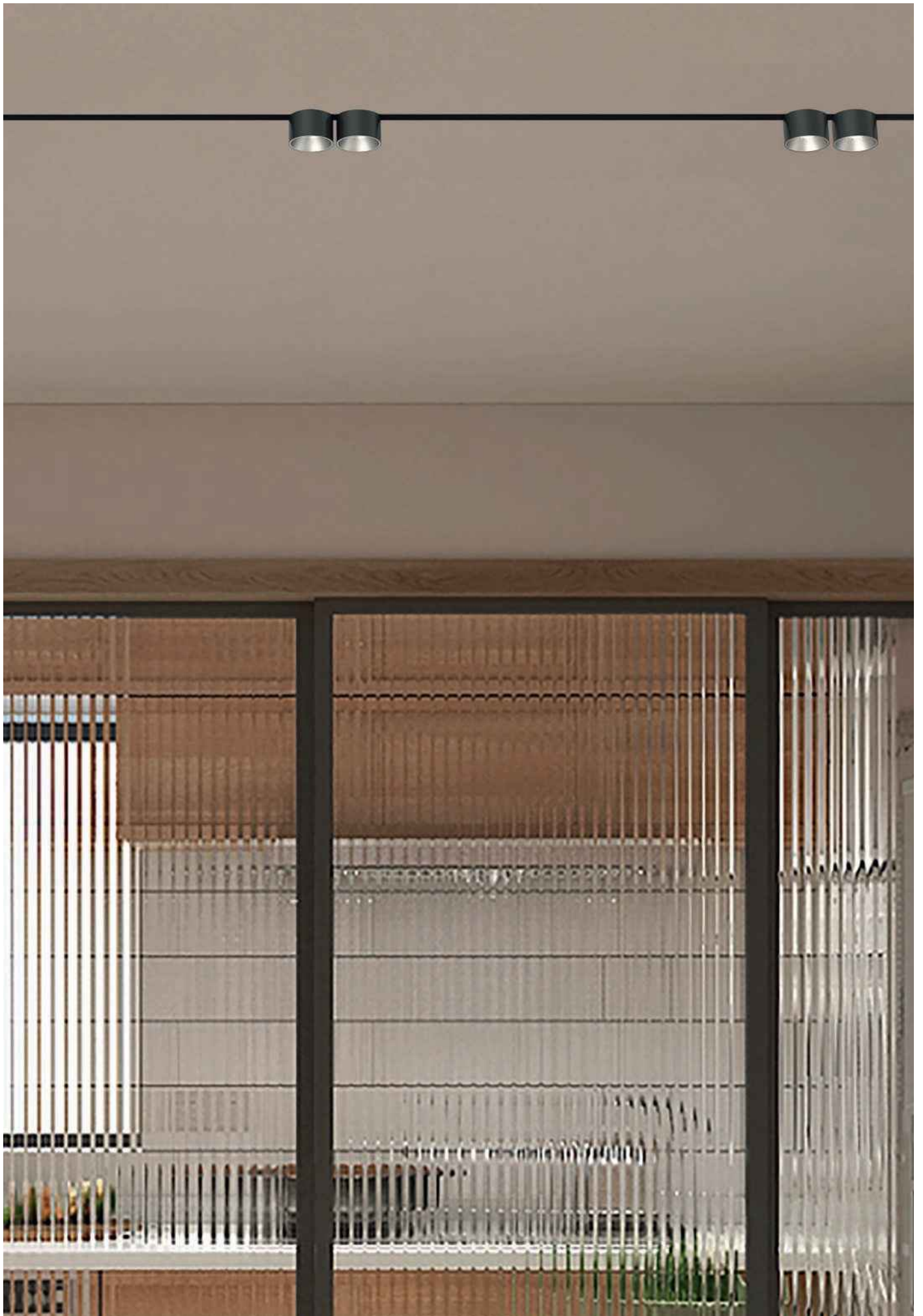

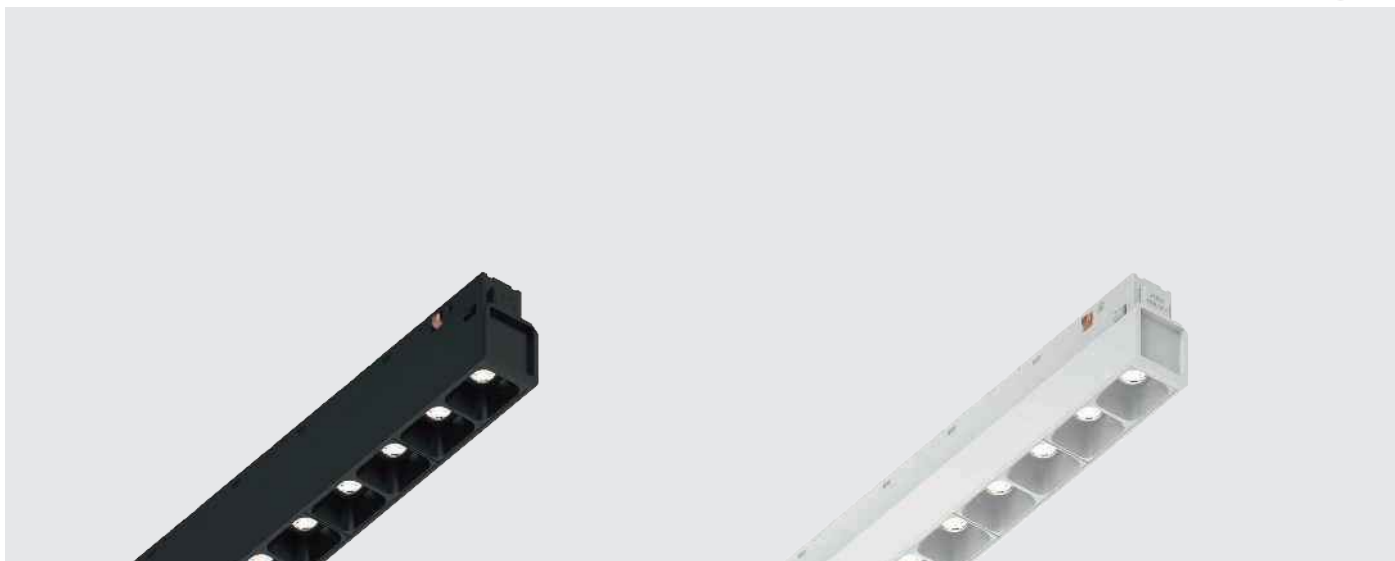
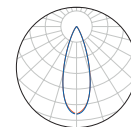

Das leistungsstarke Linsenmodul für das modulare LINE48V Niedervolt-System verspricht eine Vielzahl von unterschiedlichen Konfigurationsmöglichkeiten. Die Farbtemperatur ist in 2700K, 3000K und 4000K erhältlich und kann mit einem Farbwiedergabeindex >90 an Ihre Anforderungen angepasst werden. Durch den tiefen Einbau der LED in das Gehäuse bietet die LINE48V Lens Module einen hohen Sehkomfort mit einem UGR-Wert <16. Die Lichteinsätze werden durch einen einfachen Klick-Mechanismus mit dem Profil verbunden, was ein hohes Maß an Flexibilität ohne den Einsatz von Werkzeug bietet. Um den Anforderungen professioneller Beleuchtungsaufgaben gerecht zu werden, kann das Linsenmodul sowohl mit on/off- als auch mit DALI-Treibern ausgewählt werden.

The powerful Lens Module for the modular LINE48V Low Voltage System promises a variety of different configurations options. The colour temperature is available in 2700K, 3000K and 4000K and can be adapted to your requirements with a colour rendering index >90. Due to the fact that the LED is installed deep in the housing, the LINE48V Accent Light LM offers a high visual comfort and a glare-free illumination with a UGR value <16. The light inserts will be connected to the profile by a simple click-in mechanism, which offers a high degree of flexibility without using any tools. To meet the requirements of professional lighting task, the Accent Light can be selected with on/off as well as with DALI drivers.

Le puissant module de lentille pour le système modulaire à basse tension LINE48V offre une grande variété d'options de configuration. La température de couleur est disponible en 2700K, 3000K et 4000K et peut être adaptée à vos besoins avec un indice de rendu des couleurs >90. Du fait que la LED est installée profondément dans le boîtier, la LINE48V Accent Light LM offre un confort visuel élevé et un éclairage sans éblouissement avec une valeur UGR <16. Les inserts lumineux seront connectés au profilé par un simple mécanisme d'encliquetage, ce qui offre un haut degré de flexibilité sans l'utilisation d'outils. Pour répondre aux exigences d'un éclairage professionnel, l'Accent Light peut être sélectionné avec des pilotes on/off ou DALI.

## ÜBERSICHT | OVERVIEW | VUE D'ENSEMBLE

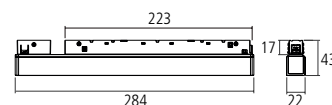

dimmable	colour	dimensions [mm]	colour temp. [K]	luminous flux [lm]	weight [kg]	material number
	■ black [RAL 9005]	L 284 / W 22 / H 43	2700	1131	0,2	<b>648LM-029271-OOBLB</b>
	□ white [RAL 9016]	L 284 / W 22 / H 43	2700	1131	0,2	<b>648LM-029271-OOWHW</b>
	■ black [RAL 9005]	L 284 / W 22 / H 43	3000	1202	0,2	<b>648LM-029301-OOBLB</b>
	□ white [RAL 9016]	L 284 / W 22 / H 43	3000	1202	0,2	<b>648LM-029301-OOWHW</b>
	■ black [RAL 9005]	L 284 / W 22 / H 43	4000	1360	0,2	<b>648LM-029401-OOBLB</b>
	□ white [RAL 9016]	L 284 / W 22 / H 43	4000	1360	0,2	<b>648LM-029401-OOWHW</b>
DALI 2	■ black [RAL 9005]	L 284 / W 22 / H 43	2700	1131	0,2	<b>648LM-029271-DDBLB</b>
	□ white [RAL 9016]	L 284 / W 22 / H 43	2700	1131	0,2	<b>648LM-029271-DDWHW</b>
	■ black [RAL 9005]	L 284 / W 22 / H 43	3000	1202	0,2	<b>648LM-029301-DDBLB</b>
	□ white [RAL 9016]	L 284 / W 22 / H 43	3000	1202	0,2	<b>648LM-029301-DDWHW</b>
	■ black [RAL 9005]	L 284 / W 22 / H 43	4000	1360	0,2	<b>648LM-029401-DDBLB</b>
	□ white [RAL 9016]	L 284 / W 22 / H 43	4000	1360	0,2	<b>648LM-029401-DDWHW</b>



# LINE48V

OPAL MODULE | OPAL MODULE | OPAL MODULE

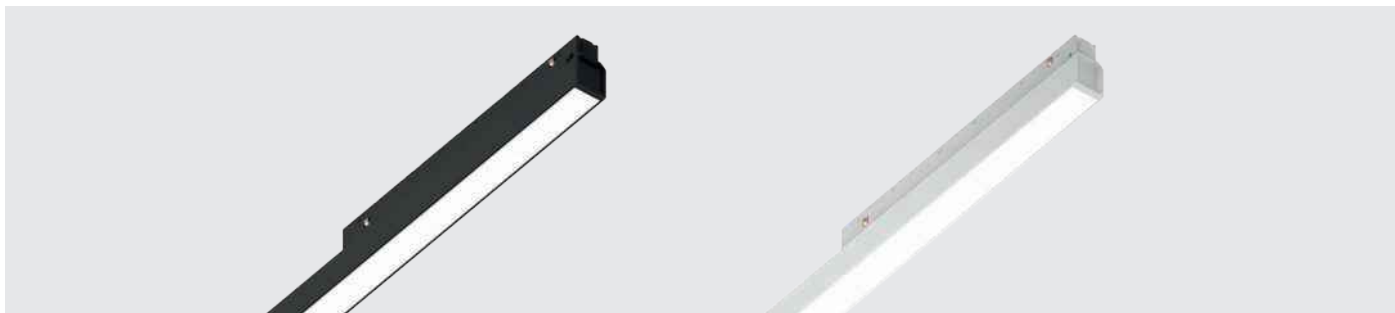
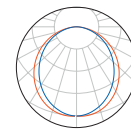

Das LINE48V Opal Modul ist in zwei verschiedenen Längen für das module LINE48V Niedervolt-System erhältlich, um einen nahtlosen Übergang der Allgemeinbeleuchtung zu gewährleisten. Von einer Länge der Allgemeinbeleuchtung von 560 mm mit 13 W, bis zu einer Länge von 1120 mm mit 26 W können homogene Beleuchtungslösungen für unterschiedlichste Planungssituationen geschaffen werden. Die Farbtemperatur ist in 2700K, 3000K und 4000K erhältlich und kann mit einem Farbwiedergabeindex >90 an Ihre Anforderungen angepasst werden. Die Lichteinsätze werden durch einen einfachen Einrastmechanismus mit dem Profil verbunden, was ein hohes Maß an Flexibilität ohne den Einsatz von Werkzeugen bietet. Um den Anforderungen professioneller Beleuchtungsaufgaben gerecht zu werden, kann das Opal Modul sowohl mit on/off- als auch mit DALI-Treibern gewählt werden.

The LINE48V Opal Module is available in two different lengths for the LINE48V Low Voltage system to ensure a seamless transition of general lighting. From a length of the General Light of 560 mm with 13 W to a length of 1120 mm with 26 W, homogenous lighting solutions can be created for a wide range of planning situations. The color temperature is available in 2700K, 3000K and 4000K and can be adapted to your requirements with a color rendering index >90. The light inserts will be connected to the profile by a simple click-in mechanism, which offers a high degree of flexibility without using any tools. To meet the requirements of professional lighting task, the Opal Module can be selected with on/off as well as with DALI drivers.

Le module opale LINE48V est disponible en deux longueurs différentes pour le système basse tension LINE48V afin d'assurer une transition transparente de l'éclairage général. D'une longueur de 560 mm avec 13 W à une longueur de 1120 mm avec 26 W, des solutions d'éclairage homogènes peuvent être créées pour un large éventail de situations de planification. La température de couleur est disponible en 2700K, 3000K et 4000K et peut être adaptée à vos besoins avec un indice de rendu des couleurs >90. Les modules d'éclairage sont reliés au profilé par un simple mécanisme d'encliquetage, ce qui offre une grande flexibilité sans l'utilisation d'outils. Pour répondre aux exigences d'un éclairage professionnel, le module Opal peut être sélectionné avec des pilotes on/off ou DALI.

## ÜBERSICHT | OVERVIEW | VUE D'ENSEMBLE

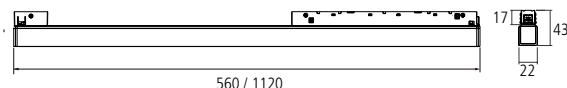

dimmable	colour	dimensions [mm]	colour temp. [K]	luminous flux [lm]	power [W]	weight [kg]	material number
✖	■ black [RAL 9005]	L 560 / W 22 / H 43	2700	798	13	0,56	<b>6480M-059271-OOBLO</b>
	□ white [RAL 9016]	L 560 / W 22 / H 43	2700	798	13	0,56	<b>6480M-059271-OOWHO</b>
	■ black [RAL 9005]	L 560 / W 22 / H 43	3000	849	13	0,56	<b>6480M-059301-OOBLO</b>
	□ white [RAL 9016]	L 560 / W 22 / H 43	3000	849	13	0,56	<b>6480M-059301-OOWHO</b>
	■ black [RAL 9005]	L 560 / W 22 / H 43	4000	890	13	0,56	<b>6480M-059401-OOBLO</b>
	□ white [RAL 9016]	L 560 / W 22 / H 43	4000	890	13	0,56	<b>6480M-059401-OOWHO</b>
	■ black [RAL 9005]	L 1120 / W 22 / H 43	2700	1513	26	0,96	<b>6480M-119271-OOBLO</b>
	□ white [RAL 9016]	L 1120 / W 22 / H 43	2700	1513	26	0,96	<b>6480M-119271-OOWHO</b>
	■ black [RAL 9005]	L 1120 / W 22 / H 43	3000	1609	26	0,96	<b>6480M-119301-OOBLO</b>
	□ white [RAL 9016]	L 1120 / W 22 / H 43	3000	1609	26	0,96	<b>6480M-119301-OOWHO</b>
	■ black [RAL 9005]	L 1120 / W 22 / H 43	4000	1704	26	0,96	<b>6480M-119401-OOBLO</b>
	□ white [RAL 9016]	L 1120 / W 22 / H 43	4000	1704	26	0,96	<b>6480M-119401-OOWHO</b>
☑	■ black [RAL 9005]	L 560 / W 22 / H 43	2700	798	13	0,56	<b>6480M-059271-DOBLO</b>
	□ white [RAL 9016]	L 560 / W 22 / H 43	2700	798	13	0,56	<b>6480M-059271-DOWHO</b>
	■ black [RAL 9005]	L 560 / W 22 / H 43	3000	849	13	0,56	<b>6480M-059301-DOBLO</b>
	□ white [RAL 9016]	L 560 / W 22 / H 43	3000	849	13	0,56	<b>6480M-059301-DOWHO</b>
	■ black [RAL 9005]	L 560 / W 22 / H 43	4000	890	13	0,56	<b>6480M-059401-DOBLO</b>
	□ white [RAL 9016]	L 560 / W 22 / H 43	4000	890	13	0,56	<b>6480M-059401-DOWHO</b>
	■ black [RAL 9005]	L 1120 / W 22 / H 43	2700	1513	26	0,96	<b>6480M-119271-DOBLO</b>
	□ white [RAL 9016]	L 1120 / W 22 / H 43	2700	1513	26	0,96	<b>6480M-119271-DOWHO</b>
	■ black [RAL 9005]	L 1120 / W 22 / H 43	3000	1609	26	0,96	<b>6480M-119301-DOBLO</b>
	□ white [RAL 9016]	L 1120 / W 22 / H 43	3000	1609	26	0,96	<b>6480M-119301-DOWHO</b>
	■ black [RAL 9005]	L 1120 / W 22 / H 43	4000	1704	26	0,96	<b>6480M-119401-DOBLO</b>
	□ white [RAL 9016]	L 1120 / W 22 / H 43	4000	1704	26	0,96	<b>6480M-119401-DOWHO</b>

# LINE48V

PRISM MODULE | PRISM MODULE | PRISM MODULE

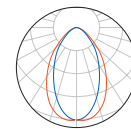

Das LINE48V Prismenmodul ist in der Länge von 1120 mm für das modulare LINE48V Niedervolt-System erhältlich, um einen nahtlosen Übergang der Allgemeinbeleuchtung mit Mikroprismen-Diffusor zu gewährleisten. Die Farbtemperatur ist in 3000K und 4000K erhältlich und kann mit einem Farbwiedergabeindex >90 an Ihre Anforderungen angepasst werden. Die Lichteinsätze werden durch einen einfachen Einrastmechanismus mit dem Profil verbunden, der ein hohes Maß an Flexibilität ohne den Einsatz von Werkzeugen bietet. Um den Anforderungen professioneller Beleuchtungsaufgaben gerecht zu werden, kann das Prismamodul sowohl mit on/off- als auch mit DALI-Treibern gewählt werden

The LINE48V Prism Module is available in the length of 1120 mm for the modular LINE48V Low Voltage system to ensure a seamless transition of general lighting with microprismatic diffuser. The color temperature is available in 3000K and 4000K and can be adapted to your requirements with a color rendering index >90. The light inserts will be connected to the profile by a simple click-in mechanism, which offers a high degree of flexibility without using any tools. To meet the requirements of professional lighting task, the Prism Module can be selected with on/off as well as with DALI drivers.

Le module de prisme LINE48V est disponible en longueur de 1120 mm pour le système modulaire LINE48V basse tension afin d'assurer une transition en douceur de l'éclairage général avec un diffuseur microprismatique. La température de couleur est disponible en 3000K et 4000K et peut être adaptée à vos besoins avec un indice de rendu des couleurs >90. Les inserts d'éclairage sont reliés au profilé par un simple mécanisme d'encliquetage qui offre un haut niveau de flexibilité sans avoir besoin d'utiliser des outils. Pour répondre aux exigences d'éclairage professionnel, le module prisme peut être choisi avec des drivers on/off ou DALI.

## ÜBERSICHT | OVERVIEW | VUE D'ENSEMBLE



dimmable	colour	dimensions [mm]	colour temp. [K]	luminous flux [lm]	weight [kg]	material number
	black [RAL 9005]	L 1120 / W 22 / H 43	3000	1670	0,96	<b>648MM-119301-OOBLM</b>
	white [RAL 9016]	L 1120 / W 22 / H 43	3000	1670	0,96	<b>648MM-119301-OOWHM</b>
	black [RAL 9005]	L 1120 / W 22 / H 43	4000	1743	0,96	<b>648MM-119401-OOBLM</b>
	white [RAL 9016]	L 1120 / W 22 / H 43	4000	1743	0,96	<b>648MM-119401-OOWHM</b>
	black [RAL 9005]	L 1120 / W 22 / H 43	3000	1670	0,96	<b>648MM-119301-DDBLM</b>
	white [RAL 9016]	L 1120 / W 22 / H 43	3000	1670	0,96	<b>648MM-119301-DDWHM</b>
	black [RAL 9005]	L 1120 / W 22 / H 43	4000	1743	0,96	<b>648MM-119401-DDBLM</b>
	white [RAL 9016]	L 1120 / W 22 / H 43	4000	1743	0,96	<b>648MM-119401-DDWHM</b>

# LINE48V

WALL WASHER | WALL WASHER | WALL WASHER

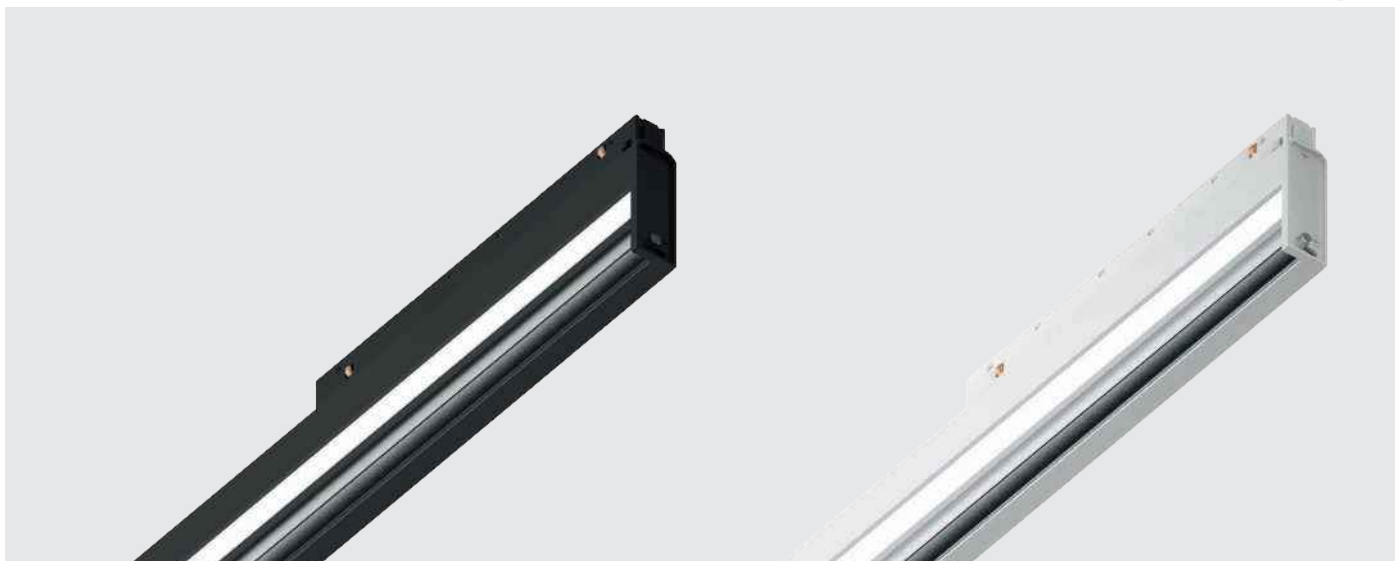
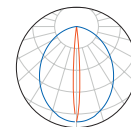

Der LINE48V Wall Washer bietet mit einer Länge von 570 mm viel Flexibilität. Das moderne Design des Wall Washer erlaubt es, den Abstrahlwinkel der Leuchte um bis zu 13° zu verstellen. Die Farbtemperatur ist in 2700K, 3000K und 4000K erhältlich und kann mit einem Farbwiedergabeindex >90 an Ihre Anforderungen angepasst werden. Die Lichteinsätze werden durch einen einfachen Einrastmechanismus mit dem Profil verbunden, der ein hohes Maß an Flexibilität ohne den Einsatz von Werkzeugen bietet. Um den Anforderungen professioneller Beleuchtungsaufgaben gerecht zu werden, kann das Wall Washer sowohl mit on/off- als auch mit DALI-Treibern gewählt werden

The LINE48V Wall Washer provides a lot of flexibility within the length of 570 mm. The modern design of the Wall Washer allows the output angle of the light to be adjusted by up to 13°. The color temperature is available in 2700K, 3000K and 4000K and can be adapted to your requirements with a color rendering index >90. The light inserts will be connected to the profile by a simple click-in mechanism, which offers a high degree of flexibility without using any tools. To meet the requirements of professional lighting task, the Wall Washer can be selected with on/off as well as with DALI drivers.

Le lèche-mur LINE48V offre une grande flexibilité dans une longueur de 570 mm. Le design moderne du lèche-mur permet d'ajuster l'angle de sortie de la lumière jusqu'à 13°. La température de couleur est disponible en 2700K, 3000K et 4000K et peut être adaptée à vos besoins avec un indice de rendu des couleurs >90. Les inserts d'éclairage sont reliés au profilé par un simple mécanisme d'encliquetage qui offre un haut niveau de flexibilité sans avoir besoin d'utiliser des outils. Pour répondre aux exigences d'éclairage professionnel, le lèche-mur peut être choisi avec des drivers on/off ou DALI.

## ÜBERSICHT | OVERVIEW | VUE D'ENSEMBLE

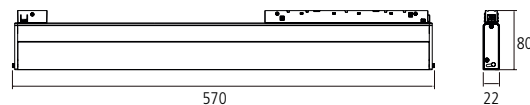

dimmable	colour	dimensions [mm]	colour temp. [K]	luminous flux [lm]	weight [kg]	material number
	■ black [RAL 9005]	L 570 / W 22 / H 80	2700	633	0,7	648AM-059271-OOBLA
	□ white [RAL 9016]	L 570 / W 22 / H 80	2700	633	0,7	648AM-059271-OOWHA
	■ black [RAL 9005]	L 570 / W 22 / H 80	3000	786	0,7	648AM-059301-OOBLA
	□ white [RAL 9016]	L 570 / W 22 / H 80	3000	786	0,7	648AM-059301-OOWHA
	■ black [RAL 9005]	L 570 / W 22 / H 80	4000	801	0,7	648AM-059401-OOBLA
	□ white [RAL 9016]	L 570 / W 22 / H 80	4000	801	0,7	648AM-059401-OOWHA
DALI 2	■ black [RAL 9005]	L 570 / W 22 / H 80	2700	633	0,71	648AM-059271-DDBLA
	□ white [RAL 9016]	L 570 / W 22 / H 80	2700	633	0,71	648AM-059271-DDWHA
	■ black [RAL 9005]	L 570 / W 22 / H 80	3000	786	0,71	648AM-059301-DDBLA
	□ white [RAL 9016]	L 570 / W 22 / H 80	3000	786	0,71	648AM-059301-DDWHA
	■ black [RAL 9005]	L 570 / W 22 / H 80	4000	801	0,71	648AM-059401-DDBLA
	□ white [RAL 9016]	L 570 / W 22 / H 80	4000	801	0,71	648AM-059401-DDWHA

# LINE48V

PIEDALE | PIEDALE | PIEDALE

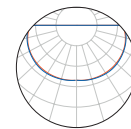

Der dekorative Glaskugeleinsatz für das LINE48V Niedervolt-System bietet ein minimalistisches, elegantes Design. LINE48V Piedale ist mit einer Pendellänge von 2000 mm erhältlich, die durch einen speziellen Mechanismus im Adapter nachträglich leicht gekürzt werden kann. Die Lichteinsätze werden durch einen einfachen Einrastmechanismus mit dem Profil verbunden, der ein hohes Maß an Flexibilität ohne den Einsatz von Werkzeug bietet. Um den Anforderungen professioneller Beleuchtungsaufgaben gerecht zu werden, kann die Piedale sowohl mit on/off- als auch mit DALI-Treibern gewählt werden

The decorative glass ball inset for the LINE48V Low Voltage System offers a minimalist, elegant design. LINE48V Piedale is available with a pendant length of 2000 mm, which can be easily shortened afterwards using the special mechanism in the adapter. The light inserts will be connected to the profile by a simple click-in mechanism, which offers a high degree of flexibility without using any tools. To meet the requirements of professional lighting task, the Piedale can be selected with on/off as well as with DALI drivers.

L'insert décoratif en verre pour le système basse tension LINE48V offre un design minimaliste et élégant. LINE48V Piedale est disponible avec une longueur de suspension de 2000 mm, qui peut être facilement raccourcie par la suite grâce au mécanisme spécial de l'adaptateur. Les modules d'éclairage seront connectés au profilé par un simple mécanisme d'encliquetage, ce qui offre un haut degré de flexibilité sans utiliser d'outils. Pour répondre aux exigences d'un éclairage professionnel, le Piedale peut être choisi avec des drivers on/off ou DALI.



## ÜBERSICHT | OVERVIEW | VUE D'ENSEMBLE



dimmable	colour	dimensions [mm]	pendulum length [mm]	colour temp. [K]	luminous flux [lm]	weight [kg]	material number
✗	■ black [RAL 9005]	Ø 120 / L 190	2000	2700	452	0,38	<b>648PP-019271-OOBLO</b>
	□ white [RAL 9016]	Ø 120 / L 190	2000	2700	452	0,38	<b>648PP-019271-OOWHO</b>
	■ black [RAL 9005]	Ø 120 / L 190	2000	3000	518	0,38	<b>648PP-019301-OOBLO</b>
	□ white [RAL 9016]	Ø 120 / L 190	2000	3000	518	0,38	<b>648PP-019301-OOWHO</b>
	■ black [RAL 9005]	Ø 120 / L 190	2000	4000	551	0,38	<b>648PP-019401-OOBLO</b>
	□ white [RAL 9016]	Ø 120 / L 190	2000	4000	551	0,38	<b>648PP-019401-OOWHO</b>
☑	■ black [RAL 9005]	Ø 120 / L 230	2000	2700	452	0,38	<b>648PP-019271-DDBLO</b>
	□ white [RAL 9016]	Ø 120 / L 230	2000	2700	452	0,38	<b>648PP-019271-DDWHO</b>
	■ black [RAL 9005]	Ø 120 / L 230	2000	3000	518	0,38	<b>648PP-019301-DDBLO</b>
	□ white [RAL 9016]	Ø 120 / L 230	2000	3000	518	0,38	<b>648PP-019301-DDWHO</b>
	■ black [RAL 9005]	Ø 120 / L 230	2000	4000	551	0,38	<b>648PP-019401-DDBLO</b>
	□ white [RAL 9016]	Ø 120 / L 230	2000	4000	551	0,38	<b>648PP-019401-DDWHO</b>



# LINE48V

CANAELLO | CANALELLO | CANALELLO

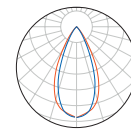

Der dekorative Hängeleuchteneinsatz für das LINE48V Niedervolt-System bietet ein hochwertiges, elegantes Design. LINE48V Canalello ist mit einer Pendellänge von 2000 mm erhältlich, die durch einen speziellen Mechanismus im Adapter nachträglich leicht gekürzt werden kann. Die Leuchteinsätze werden durch einen einfachen Einrastmechanismus mit dem Profil verbunden, der ein hohes Maß an Flexibilität ohne den Einsatz von Werkzeug bietet. Um den Anforderungen professioneller Beleuchtungsaufgaben gerecht zu werden, kann die Canalello sowohl mit on/off- als auch mit DALI-Treibern gewählt werden

The decorative pendant inset for the LINE48V Low Voltage System offers a high quality, elegant design. LINE48V Canalello is available with a pendant length of 2000 mm, which can be easily shortened afterwards using the special mechanism in the adapter. The light inserts will be connected to the profile by a simple click-in mechanism, which offers a high degree of flexibility without using any tools. To meet the requirements of professional lighting task, the Canalello can be selected with on/off as well as with DALI drivers.

La suspension décorative pour le système basse tension LINE48V offre un design élégant et de haute qualité. LINE48V Canalello est disponible avec une longueur de suspension de 2000 mm, qui peut être facilement raccourcie par la suite grâce au mécanisme spécial de l'adaptateur. Les modules d'éclairage seront connectés au profilé par un simple mécanisme d'encliquetage, ce qui offre un haut degré de flexibilité sans l'utilisation d'outils. Pour répondre aux exigences d'éclairage professionnel, le module prisme Canalello peut être choisi avec des drivers on/off ou DALI.

## ÜBERSICHT | OVERVIEW | VUE D'ENSEMBLE

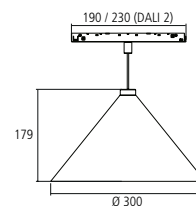

dimmable	colour	dimensions [mm]	pendulum length [mm]	colour temp. [K]	luminous flux [lm]	weight [kg]	material number
	■ black [RAL 9005]	Ø 300 / L 190 / H 179	2000	2700	893	0,6	<b>648PC-039271-OOBLB</b>
	□ white [RAL 9016]	Ø 300 / L 190 / H 179	2000	2700	893	0,6	<b>648PC-039271-OOWHW</b>
	■ black [RAL 9005]	Ø 300 / L 190 / H 179	2000	3000	951	0,6	<b>648PC-039301-OOBLB</b>
	□ white [RAL 9016]	Ø 300 / L 190 / H 179	2000	3000	951	0,6	<b>648PC-039301-OOWHW</b>
	■ black [RAL 9005]	Ø 300 / L 190 / H 179	2000	4000	1163	0,6	<b>648PC-039401-OOBLB</b>
	□ white [RAL 9016]	Ø 300 / L 190 / H 179	2000	4000	1163	0,6	<b>648PC-039401-OOWHW</b>
DALI 2	■ black [RAL 9005]	Ø 300 / L 230 / H 179	2000	2700	893	0,6	<b>648PC-039271-DDBLB</b>
	□ white [RAL 9016]	Ø 300 / L 230 / H 179	2000	2700	893	0,6	<b>648PC-039271-DDWHW</b>
	■ black [RAL 9005]	Ø 300 / L 230 / H 179	2000	3000	951	0,6	<b>648PC-039301-DDBLB</b>
	□ white [RAL 9016]	Ø 300 / L 230 / H 179	2000	3000	951	0,6	<b>648PC-039301-DDWHW</b>
	■ black [RAL 9005]	Ø 300 / L 230 / H 179	2000	4000	1163	0,6	<b>648PC-039401-DDBLB</b>
	□ white [RAL 9016]	Ø 300 / L 230 / H 179	2000	4000	1163	0,6	<b>648PC-039401-DDWHW</b>







# LINE48V

TORTORETO | TORTORETO | TORTORETO

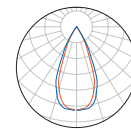

Die minimalistisch gestaltete Pendelleuchte Tortoreto für das LINE48V Niedervolt-System sorgt für eine hervorragende Akzentbeleuchtung mit bester Lichtqualität. Mit einem Durchmesser von Ø 40 mm können unterschiedliche Formen und Größen von wechselnden Objekten ins rechte Licht gerückt werden. Die tief sitzende LED im Inneren der Pendelleuchte sorgt für einen hohen Sehkomfort mit einem UGR-Wert von <19. Die Lichteinsätze werden durch einen einfachen Einrastmechanismus mit dem Profil verbunden, was ein hohes Maß an Flexibilität ohne den Einsatz von Werkzeug bietet. Um den Anforderungen professioneller Beleuchtungsaufgaben gerecht zu werden, kann die Tortoreto sowohl mit on/off- als auch mit DALI-Treibern gewählt werden.

The minimalist designed pendant Tortoreto for LINE48V ensure excellent accent lighting with the best light quality. With a diameter of Ø 40 mm, different shapes and sizes of changing objects can be put into the right light. The low-seat LED inside the pendant lamp provides a high level of visual comfort with a UGR value of <19. The light inserts will be connected to the profile by a simple click-in mechanism, which offers a high degree of flexibility without using any tools. To meet the requirements of professional lighting task, the Tortoreto can be selected with on/off as well as with DALI drivers.

La suspension Tortoreto pour LINE48V, au design minimaliste, assure un excellent éclairage d'accentuation avec une qualité de lumière optimale. Avec un diamètre de 40 mm, les objets changeants de formes et de tailles différentes peuvent être placés dans la bonne lumière. La LED à assise basse à l'intérieur de la lampe suspendue offre un niveau élevé de confort visuel avec une valeur UGR de <19. Les modules d'éclairage seront connectés au profilé par un simple mécanisme d'encliquetage, ce qui offre un haut degré de flexibilité sans l'utilisation d'outils. Pour répondre aux exigences d'éclairage professionnel, le Tortoreto peut être choisi avec des drivers on/off ou DALI.

## ÜBERSICHT | OVERVIEW | VUE D'ENSEMBLE

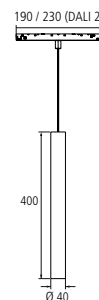

dimmmable	colour	dimensions [mm]	pendulum length [mm]	colour temp. [K]	luminous flux [lm]	weight [kg]	material number
	■ black [RAL 9005]	Ø 40 / L 190 / H 400	2000	2700	539	0,65	<b>648PT-309271-OOBLB</b>
	□ white [RAL 9016]	Ø 40 / L 190 / H 400	2000	2700	539	0,65	<b>648PT-309271-OOWHW</b>
	■ black [RAL 9005]	Ø 40 / L 190 / H 400	2000	3000	573	0,65	<b>648PT-309301-OOBLB</b>
	□ white [RAL 9016]	Ø 40 / L 190 / H 400	2000	3000	573	0,65	<b>648PT-309301-OOWHW</b>
	■ black [RAL 9005]	Ø 40 / L 190 / H 400	2000	4000	642	0,65	<b>648PT-309401-OOBLB</b>
	□ white [RAL 9016]	Ø 40 / L 190 / H 400	2000	4000	642	0,65	<b>648PT-309401-OOWHW</b>
DALI 2	■ black [RAL 9005]	Ø 40 / L 230 / H 400	2000	2700	539	0,65	<b>648PT-309271-DDBLB</b>
	□ white [RAL 9016]	Ø 40 / L 230 / H 400	2000	2700	539	0,65	<b>648PT-309271-DDWHW</b>
	■ black [RAL 9005]	Ø 40 / L 230 / H 400	2000	3000	573	0,65	<b>648PT-309301-DDBLB</b>
	□ white [RAL 9016]	Ø 40 / L 230 / H 400	2000	3000	573	0,65	<b>648PT-309301-DDWHW</b>
	■ black [RAL 9005]	Ø 40 / L 230 / H 400	2000	4000	642	0,65	<b>648PT-309401-DDBLB</b>
	□ white [RAL 9016]	Ø 40 / L 230 / H 400	2000	4000	642	0,65	<b>648PT-309401-DDWHW</b>

# LINE48V

ROBE | ROBE | ROBE

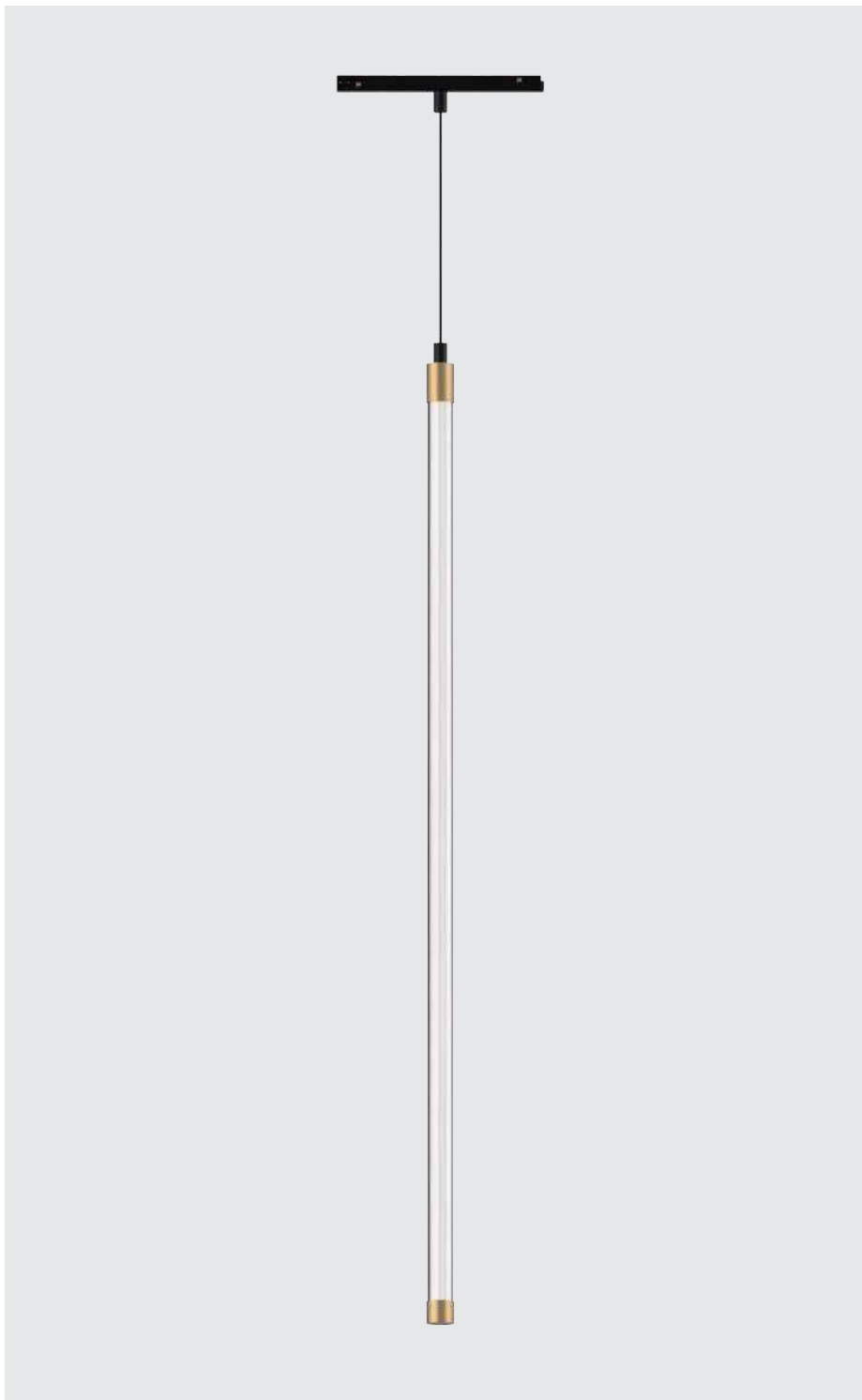
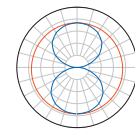

Die minimalistisch gestaltete Neonflex-Pendelleuchte für das LINE48V Niedervolt-System sorgt für eine exzellente Akzentbeleuchtung mit einem 360°-Lichtaustritt. Die Lichteinsätze werden durch einen einfachen Einrastmechanismus mit dem Profil verbunden, der ein hohes Maß an Flexibilität ohne den Einsatz von Werkzeug bietet.

The minimalist designed neon flex pendant luminaire for LINE48V ensure excellent accent lighting with a 360° light emission. The light inserts will be connected to the profile by a simple click-in mechanism, which offers a high degree of flexibility without using any tools.

Le luminaire suspendu néon flex au design minimaliste pour LINE48V assure un excellent éclairage d'accentuation avec une émission de lumière à 360°. Les inserts lumineux seront connectés au profilé par un simple mécanisme d'encliquetage, ce qui offre un haut degré de flexibilité sans utiliser d'outils.

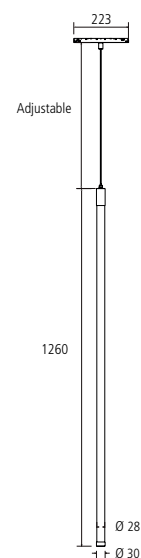

## ÜBERSICHT | OVERVIEW | VUE D'ENSEMBLE

LED CRI >90 3 SDCM III >50,000h 180° 48V

colour	dimensions [mm]	pendulum length [mm]	colour temp. [K]	luminous flux [lm]	weight [kg]	material number
■ gold	Ø 30 / L 223 / H 1260	2000	2700	1980	1,25	<b>648RS-059271-OOBLG</b>
■ gold	Ø 30 / L 223 / H 1260	2000	3000	2273	1,25	<b>648RS-059301-OOBLG</b>
■ gold	Ø 30 / L 223 / H 1260	2000	4000	2418	1,25	<b>648RS-059401-OOBLG</b>

# LINE48V

ROBE | ROBE | ROBE

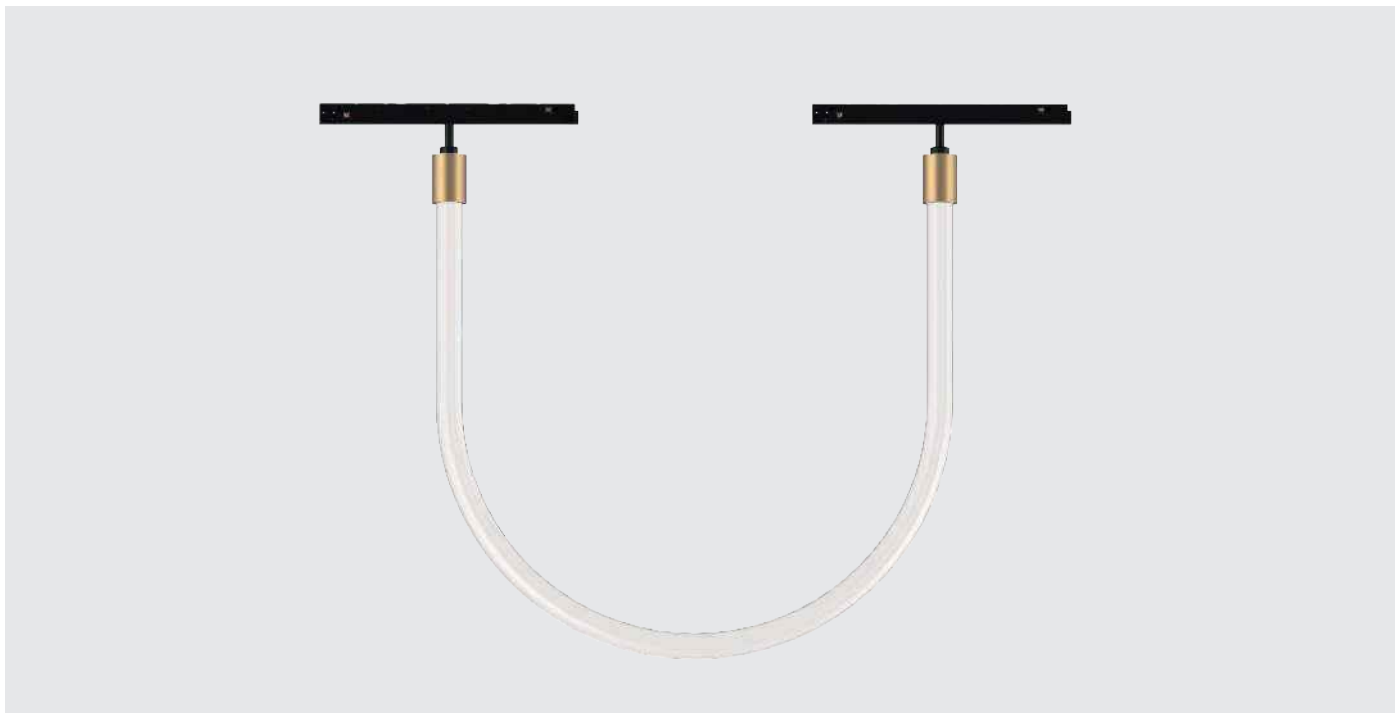
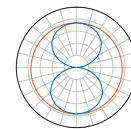

Die minimalistisch gestaltete Neonflex-Pendelleuchte für das LINE48V Niedervolt-System sorgt für eine exzellente Akzentbeleuchtung mit einem 360°-Lichtaustritt. Die Lichteinsätze werden durch einen einfachen Einrastmechanismus mit dem Profil verbunden, der ein hohes Maß an Flexibilität ohne den Einsatz von Werkzeug bietet.

The minimalist designed neon flex pendant luminaire for LINE48V ensure excellent accent lighting with a 360° light emission. The light inserts will be connected to the profile by a simple click-in mechanism, which offers a high degree of flexibility without using any tools.

Le luminaire suspendu néon flex au design minimaliste pour LINE48V assure un excellent éclairage d'accentuation avec une émission de lumière à 360°. Les inserts lumineux seront connectés au profilé par un simple mécanisme d'encliquetage, ce qui offre un haut degré de flexibilité sans utiliser d'outils.

## ÜBERSICHT | OVERVIEW | VUE D'ENSEMBLE

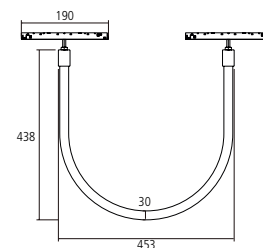

colour	dimensions [mm]	colour temp. [K]	luminous flux [lm]	weight [kg]	material number
gold	Ø 30 / L 190 / H 1200	2700	1980	1,25	648RU-309271-OOBLG
gold	Ø 30 / L 190 / H 1200	3000	2273	1,25	648RU-309301-OOBLG
gold	Ø 30 / L 190 / H 1200	4000	2418	1,25	648RU-309401-OOBLG



# LINE48V

IN-TRACK TREIBER 48VDC 100W | DRIVER IN-TRACK 48VDC 100W | DRIVER IN-TRACK 48VDC 100W



## ÜBERSICHT | OVERVIEW | VUE D'ENSEMBLE

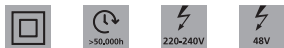

dimmbare	colour	dimensions [mm]	cable length [mm]	power [W]	output voltage [Vdc]	weight [kg]	material number
	■ black [RAL 9005]	L 297,5 / W 16 / H 19	250	100	48	0,14	<b>69351</b>
	□ white [RAL 9016]	L 297,5 / W 16 / H 19	250	100	48	0,14	<b>69353</b>
	■ black [RAL 9005]	L 297,5 / W 16 / H 19	3000	100	48	0,14	<b>69405</b>
	□ white [RAL 9016]	L 297,5 / W 16 / H 19	3000	100	48	0,14	<b>69406</b>
	■ black [RAL 9005]	L 297,5 / W 16 / H 19	250	100	48	0,14	<b>69352</b>
	□ white [RAL 9016]	L 297,5 / W 16 / H 19	250	100	48	0,14	<b>69354</b>
	■ black [RAL 9005]	L 297,5 / W 16 / H 19	3000	100	48	0,14	<b>69409</b>
	□ white [RAL 9016]	L 297,5 / W 16 / H 19	3000	100	48	0,14	<b>69411</b>

DALI: 2 EXTRA LEADS FOR DALI THROUGH WIRING

# LINE48V

IN-TRACK TREIBER 48VDC 250W | DRIVER IN-TRACK 48VDC 250W | DRIVER IN-TRACK 48VDC 250W



## ÜBERSICHT | OVERVIEW | VUE D'ENSEMBLE

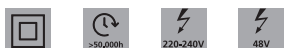

dimmbare	colour	dimensions [mm]	cable length [mm]	power [W]	output voltage [Vdc]	weight [kg]	material number
	■ black [RAL 9005]	L 268 / W 22 / H 43,5	250	250	48	0,32	<b>69355</b>
	□ white [RAL 9016]	L 268 / W 22 / H 43,5	250	250	48	0,32	<b>69357</b>
	■ black [RAL 9005]	L 268 / W 22 / H 43,5	3000	250	48	0,32	<b>69407</b>
	□ white [RAL 9016]	L 268 / W 22 / H 43,5	3000	250	48	0,32	<b>69408</b>
	■ black [RAL 9005]	L 268 / W 22 / H 43,5	250	250	48	0,32	<b>69356</b>
	□ white [RAL 9016]	L 268 / W 22 / H 43,5	250	250	48	0,32	<b>69358</b>
	■ black [RAL 9005]	L 268 / W 22 / H 43,5	3000	250	48	0,32	<b>69412</b>
	□ white [RAL 9016]	L 268 / W 22 / H 43,5	3000	250	48	0,32	<b>69413</b>

DALI: 2 EXTRA LEADS FOR DALI THROUGH WIRING

# LINE48V

EXTERNER TREIBER 48VDC 320/480W | EXTERNAL DRIVER 48VDC 320/480W | DRIVER EXTERNAL 48VDC 320/480W

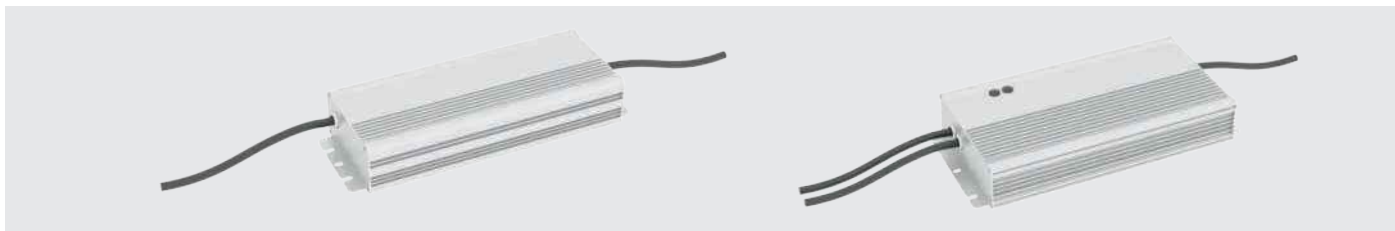

## ÜBERSICHT | OVERVIEW | VUE D'ENSEMBLE



dimmable	driver name	colour	dimensions [mm]	cable length [mm]	power [W]	output voltage [Vdc]	weight [kg]	material number
	HLG-320H-48A	■ silver [aluminium]	L 252 / W 90 / H 44	300	320	48	1,88	<b>69361</b>
	HLG-480H-48A	■ silver [aluminium]	L 262 / W 125 / H 19	300	480	48	2,80	<b>69362</b>

# LINE48V

OPTOISOLIERTER VERSTÄRKER DALI | OPTO-INSULATED REPEATER DALI | AMPLIFICATEUR OPTO-ISOLÉ DALI  
SIGNAL CONTROLLER



Das Gerät ist ein mit dem DALI-Protokoll kompatibler Signalverstärker und Regenerator mit integrierter Stromversorgung für die Ausgangsleitung. Es wird verwendet, um die digitale Eingangsleitung von der Ausgangsleitung zu verlängern oder/und elektrisch zu isolieren. Dank des integrierten Netzteils ist keine Stromversorgung für die DALI-kompatible Ausgangsleitung erforderlich.

The device is a signal repeater and regenerator compatible with DALI protocol including an integrated power supply for the output line. It's used to extend or/and to electrically isolate the digital input line from the output line. Thanks to the integrated power supply, there is no need of a power supply for the output DALI compatible line.

L'appareil est un répéteur et régénérateur de signaux compatible avec le protocole DALI, comprenant une alimentation intégrée pour la ligne de sortie. Il est utilisé pour prolonger et/ou isoler électriquement la ligne d'entrée numérique de la ligne de sortie. Grâce à l'alimentation intégrée, il n'est pas nécessaire d'avoir une alimentation pour la ligne de sortie compatible avec le protocole DALI.

## ÜBERSICHT | OVERVIEW | VUE D'ENSEMBLE



dimmable	colour	dimensions [mm]	input voltage [Vdc]	output voltage [Vdc]	output current Dali [mA]	weight [kg]	material number
	□ white	L 172 / W 42 / H 25	24 / 48	24 / 48	250	0,09	<b>69359</b>

# FARBENVARIABILITÄT GEHÄUSEFARBEN NACH RAL

COLOUR VARIABILITY – RAL HOUSING COLOURS

VARIABILITÉ DES COULEURS – COULEURS DU BOÎTIER RAL

Standardfarben  
default colours  
*couleurs par défaut*

GEHÄUSE | HOUSING | LOGEMENT

DEKORRING | DECORATION RING | DÉCOR ANNEAU  
ROUND90 & SQUARE90

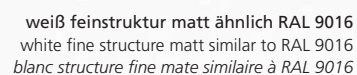
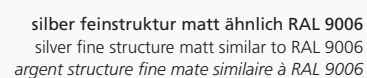
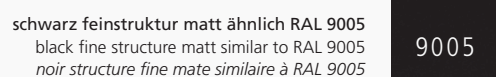
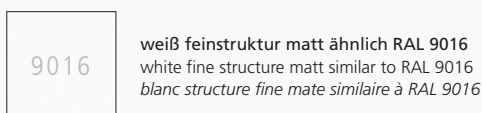
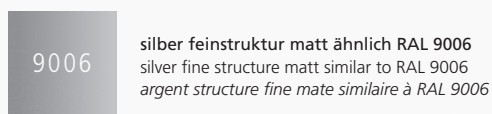
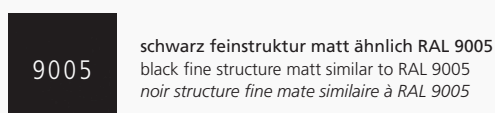

schlaggold  
beaten gold  
*or texturés*



schlagsilber  
beaten silver  
*argent texturés*



schlagbronze  
beaten bronze  
*bronze texturés*





RAL-Farbe nach Wahl auf Anfrage  
 RAL colour of your choice on demand  
 couleur RAL de votre choix sur demande

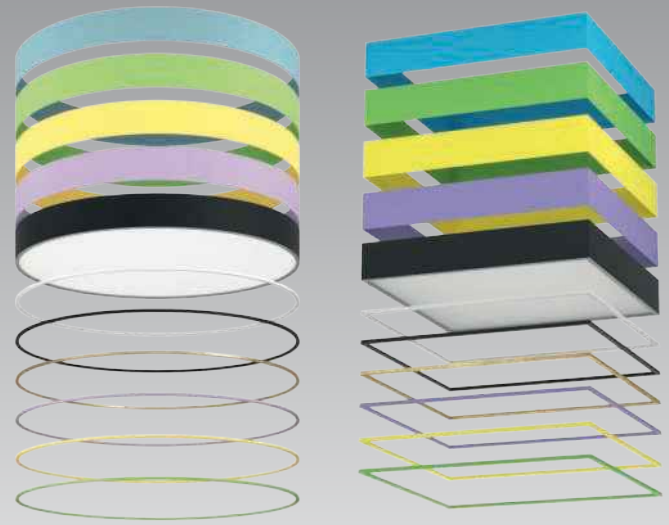

1001	1003	1004	1013	1014					
1015	1016	1018	1019	1021					
1023	1035	1036	2000	2001					
2003	2008	2009	3000	3002	3003	3009	3011	3013	
3016	3018	3020	3031	3032	3033	4005	4010	4011	
4012	5002	5004	5010	5012	5013	5018	5023	5024	
5025	5026	6013	6014	6017	6018	6019	6027	6034	
7001	7004	7006	7011	7012	7013	7015	7016	7021	
7022	7024	7030	7031	7032	7035	7037	7038	7039	
7043	7044	7047	7048	8003	8011	8012	8016	8017	
8019	8024	8028	8029	9001	9003	9011	9017	9022	

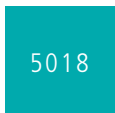

EGLO Farbe RAL 5018  
 EGLO colour RAL 5018  
 EGLO couleur RAL 5018

# LEGENDE & PIKTOGRAMME

LEGEND & PICTOGRAMS | *LÉGENDE & PICTOGRAMMES*

## FASSUNGEN | SOCKETS | *DOUILLES*

 LED

 GU10

## VOLT | VOLTAGE | *VOLTAGE*

 3-Phasenschienen | 3-phase track spotlight | *projecteur sur rail phases*

 24V

 48V

 220-240V 50/60Hz

 230V AC

## FUNKTIONEN & KOMFORT | FUNKTIONS & CONFORT | *FONCTIONS & CONFORT*

 Colour Rendering Index (80, 90, 92, 95)

 MacADAM Step (SDCM2-/3-/6)

 Lebensdauer | lifetime | *durée de vie (50.000h, 62.000h, 100.000h)*

 schwenkbar | swiveling | *tournant*

 drehbar | rotatable | *rotatif*

## FUNKTIONEN & KOMFORT | FUNKTIONS & CONFORT | *FONCTIONS & CONFORT*

 Ausstrahlwinkel | beam angle | *angle de rayonnement*

 Ausschnitt (in mm) | cutout (in mm) | *perçage du panneau (en mm)*

 Einbaubreite (in mm) | installation width (in mm) | *largeur d'installation (en mm)*

 Einbautiefe (in mm) | Mounting Depth (in mm) | *Profondeur de montage (en mm)*

 vereinheitlichte Blendungsbewertung | unified Glare Rating | *d'Évaluation unifiée de l'éblouissement (UGR 12, 16, 19, 22)*

 Insect-protected | insektengeschützt | *Protection contre les insectes*

 ball-proof | ballwurfsicher | *anti-balles*

 Sensor | sensor | *sensor*

 nicht dimmbar | not dimmable | *ne pas graduable*

 dimmbar | dimmable | *gradable*

 DALI 2

 touchpanel

 Pushbutton

 Fernbedienung | remote control | *télécommande*

 TRIAC

 UKCA

 CE

BESONDERER FUNKTIONEN |  
SPECIAL LEVEL OF FUNCTION | NIVEAU SPÉCIAL DE FONCTION



insektengeschützt | insect-protected | protection contre les insectes

Es handelt sich hier um eine insekten- und staubgeschützte Leuchte. Hierbei ist zumindest das Leuchtgehäuse und die sichtbare Leuchtfläche so geschützt, dass keine Insekten eindringen können. (Entspricht IP50).

This is an insect- and dust-proof luminaire. In this case, at least the luminaire housing and the visible illuminated surface shall be protected in such a way that insects cannot penetrate. (equivalent to IP50).

Il s'agit d'un luminaire résistant aux insectes et à la poussière. Dans ce cas, au moins le boîtier du luminaire et la surface éclairée visible doivent être protégés de manière à empêcher les insectes de pénétrer. (équivalent à IP50).



ballwurfsicher | ball-proof | anti-balles

Ballwurfsicherheit nach | Ball-proof according to | Résistant aux balles selon la norme  
DIN18032-3

SCHUTZGRAD |  
PROTECTION RATING | INDICE DE PROTECTION

Der Schutzgrad gewährleistet die Betriebssicherheit von Leuchten. Die erste Ziffer des IP Grades beschreibt den Schutzzumfang gegen das Eindringen von Fremdkörpern, die zweite Ziffer informiert über den Grad des Feuchtigkeitsschutzes.

The protection rating ensures the operational safety of luminaires. The first number specifies the extent of the protection against the ingress of foreign bodies; the second number identifies the humidity protection grade.

L'indice de protection assure la sécurité opérationnelle des luminaires. Le premier chiffre indique à quel point la protection est efficace contre l'insertion de corps étrangers; le second chiffre indique quant à lui le degré de protection par rapport à l'humidité.

IP 20	IP20	IP40 IP50	IP40/50	IP 65	IP65
IP20 IP50	IP20/50	IP 44	IP44	IP 66	IP66
IP20 IP54	IP20/54	IP 50	IP50	IP 67	IP67
IP 40	IP40	IP 54	IP54		

SCHUTZKLASSE |  
PROTECTION CLASS | CLASSE DE PROTECTION

Die Schutzklasse gibt an, inwiefern ein Produkt gegen einen elektrischen Schlag gesichert ist. Alle Leuchten in diesem Katalog sind mit mindestens Schutzklasse 1 gesichert, bei höheren Klassen wird das Symbol im Infokasten der Leuchte angegeben.

The protection class indicates to what extent the luminaire is protected against electric shock. All luminaires in this catalogue are at least protected with the protection class 1 - a higher class is specified in the information box of the respective luminaire.

La classe de protection indique, dans quelle mesure la lampe est protégée contre les chocs électriques. Tous les lampes dans ce catalogue sont protégées au moins avec la classe 1 - une classe plus élevée est indiquée dans l'information de la luminaire.



Schutzklasse 1: Schutzerdung  
protection class 1: protective earthing  
classe de protection 1: prise de terre



Schutzklasse 2: Schutzisolierung  
protection class 2: protective insulation  
classe de protection 2: double isolation ou renforcée



Schutzklasse 3: Schutzkleinspannung  
protection class 3: protective low voltage  
classe de protection 3: très basse tension de sécurité